

SMFB13W

SCHOTTKY BARRIER DIODE

SWITCHING TYPE POWER SUPPLY APPLICATIONS.

Features:

- Repetitive Peak Reverse Voltage: $V_{RRM}=30V$.
- Average Output Rectified Current: $I_O=1.0A$.
- Peak Forward Voltage: $V_{FM}=0.42V$ (max.)
- For Use in Low Voltage, High Frequency inverters, Free Wheeling, and Polarity Protection Applications.

Application:

- Switching Power Supply.
- Reversed Battery Connection Protection.
- DC/DC Converter.
- Cellular Phones.

PINNING

PIN	DESCRIPTION
1	Cathode
2	Anode

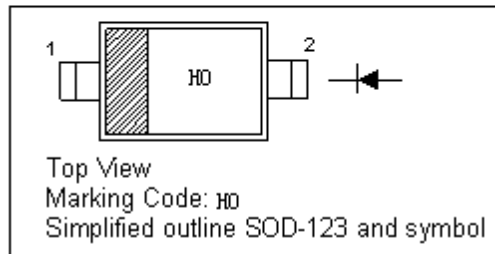

Absolute Maximum Ratings ($T_a = 25^{\circ}C$)

	Symbol	Value	Unit
Peak Repetitive Reverse Voltage	V_{RRM}	30	V
Average Rectified Output Current	I_O	1.0	A
Peak One Cycle Surge Forward Current (Non-Repetitive 60Hz)	I_{FSM}	22	A
Operating Temperature Range	T_j	-40 to +125	?
Storage Temperature Range	T_s	-40 to +125	?

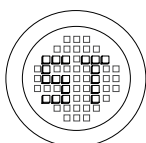

®

РАДИОТЕХ

Тел.: (495) 795-0805
Факс: (495) 234-1603
Эл. почта: info@rct.ru
Веб: www.rct.ru

SMFB13W

Characteristics at $T_{amb} = 25^{\circ}\text{C}$

	Symbol	Min.	Typ.	Max.	Unit
Peak Forward Voltage at $I_{FM} = 1.0\text{A}$	V_{FM}	-	-	0.42	V
Repetitive Peak Reverse Current at $V_{RRM} = \text{Rated}$	I_{RRM}	-	-	1.0	mA
Thermal Resistance at junction to lead at junction to ambient (on a glass-epoxy board)	$R_{th(j-l)}$ $R_{th(j-a)}$	- -	- -	20 140	$^{\circ}\text{C/W}$

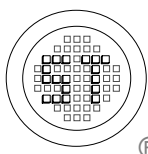

SEMTECH ELECTRONICS LTD.

(Subsidiary of Semtech International Holdings Limited, a company listed on the Hong Kong Stock Exchange, Stock Code: 724)

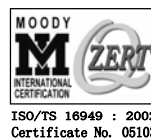

Dated : 09/03/2005

SMFB13W

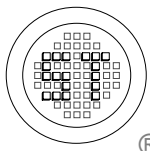
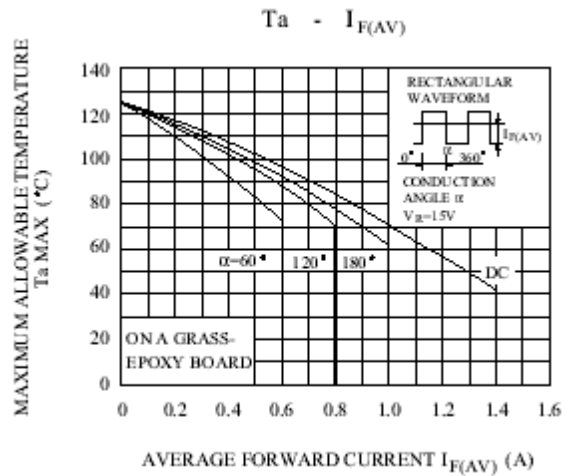
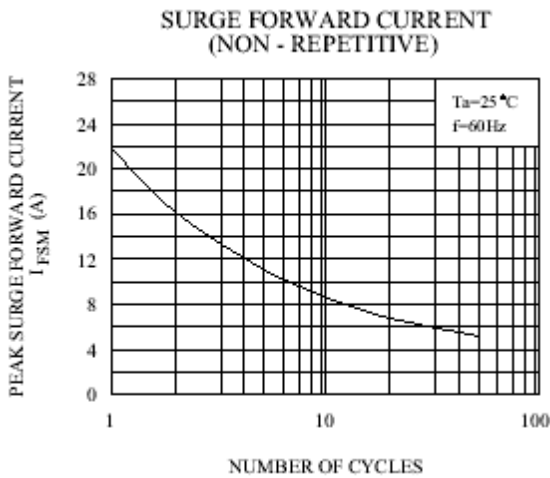
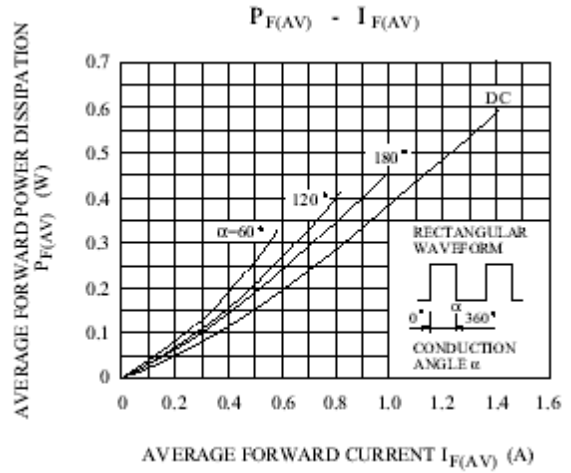
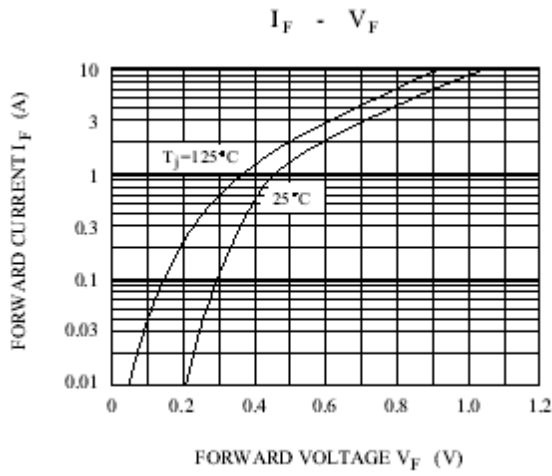

SEMTECH ELECTRONICS LTD.

(Subsidiary of Semtech International Holdings Limited, a company listed on the Hong Kong Stock Exchange, Stock Code: 724)



ISO/TS 16949 : 2002
Certificate No. 05103



ISO 14001
Certificate No. 7116



ISO 9001 : 2000
Certificate No. 550-159-04-002-04

SMFB13W

PACKAGE OUTLINE

Plastic surface mounted package; 2 leads

SOD-123

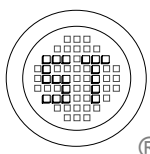
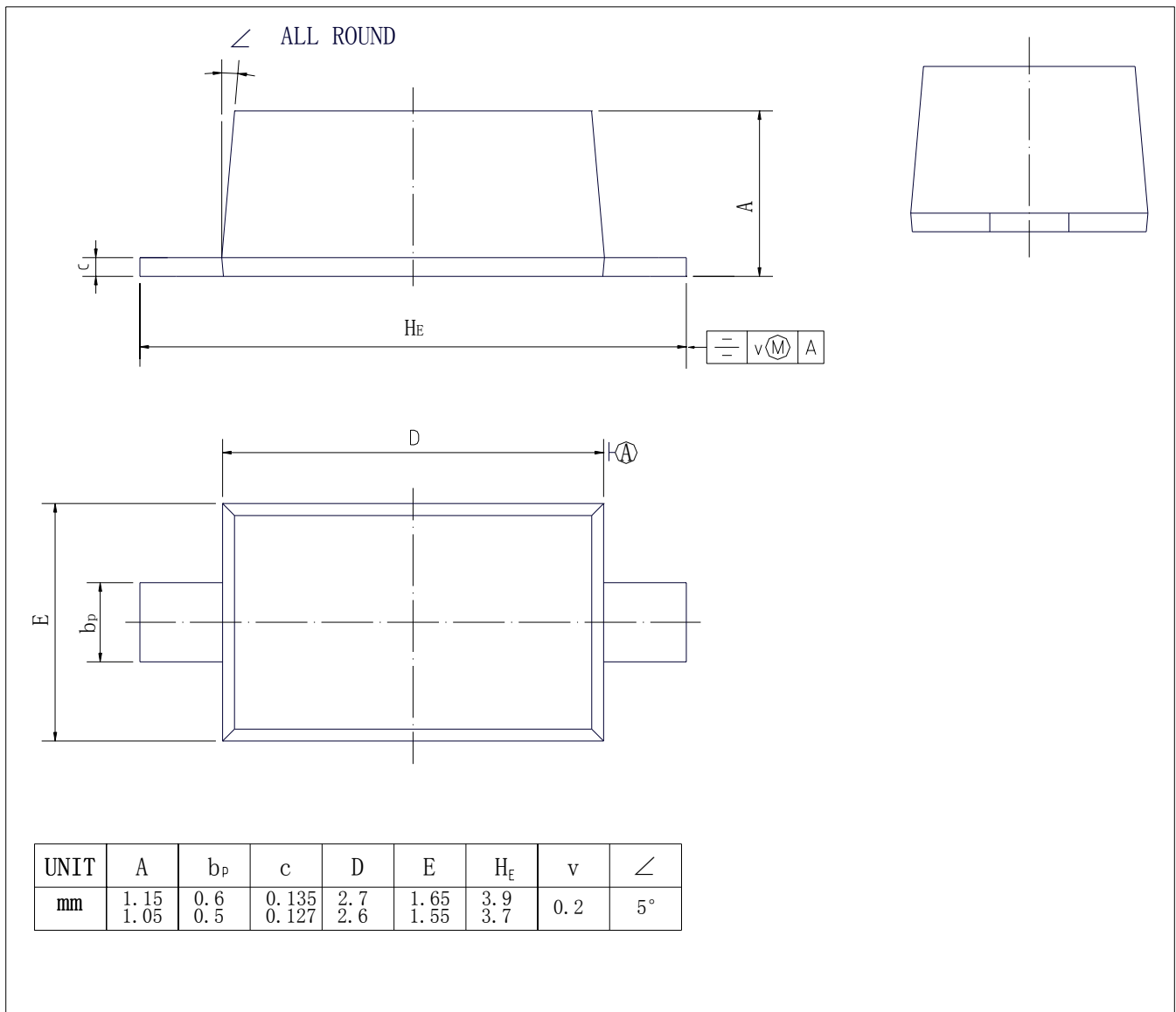

SEMTECH ELECTRONICS LTD.

(Subsidiary of Semtech International Holdings Limited, a company listed on the Hong Kong Stock Exchange, Stock Code: 724)



ISO/TS 16949 : 2002
Certificate No. 05103



ISO 14001
Certificate No. 7116



ISO 9001 : 2000
Certificate No. 550-1559-04-002-04

Dated : 09/03/2005