

# 1SS352

## SILICON EPITAXIAL PLANAR TYPE Ultra High Speed Switching Application

### Features

- Low forward voltage:  
 $V_{F(3)} = 0.98V$  (typ.)
- Fast Reverse Recovery Time:  
 $t_{rr} = 1.6ns$  (typ.)
- Small Total Capacitance:  
 $C_T = 0.5pF$  (typ.)

### PINNING

PIN	DESCRIPTION
1	Cathode
2	Anode

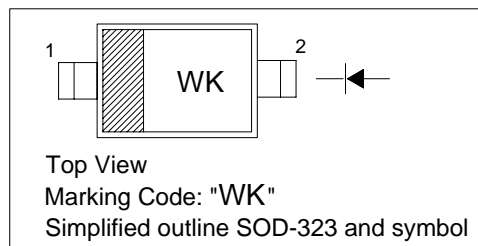

### Absolute Maximum Ratings ( $T_j = 25^\circ C$ )

Parameter	Symbol	Value	Unit
Maximum (peak) Reverse Voltage	$V_{RM}$	85	V
Reverse Voltage	$V_R$	80	V
Maximum (peak) Forward Current	$I_{FM}$	200	mA
Average Forward Current	$I_O$	100	mA
Surge Current (10ms)	$I_{FSM}$	1	A
Power Dissipation	$P_{tot}$	200	mW
Junction Temperature	$T_J$	125	°C
Storage Temperature Range	$T_s$	-55 to +125	°C

### Characteristics at $T_j = 25^\circ C$ ?

Parameter	Test Conditions	Symbol	Min	Typ	Max	Unit
Forward Voltage	$I_F = 1mA$	$V_F$	-	0.62	-	V
	$I_F = 10mA$	$V_F$	-	0.75	-	V
	$I_F = 100mA$	$V_F$	-	0.98	1.20	V
Reverse Current	$V_R = 30V$	$I_R$	-	-	0.1	$\mu A$
	$V_R = 80V$	$I_R$	-	-	0.5	$\mu A$
Total Capacitance	$f = 1MHz$	$C_T$	-	0.5	3.0	pF
Reverse Recovery Time	$I_F = 10mA$	$t_{rr}$	-	1.6	4.0	ns

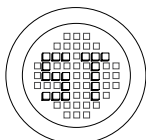

®

РАДИОТЕХ

Тел.: (495) 795-0805  
Факс: (495) 234-1603  
Эл. почта: info@rct.ru  
Веб: www.rct.ru

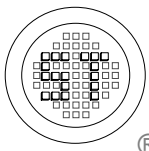
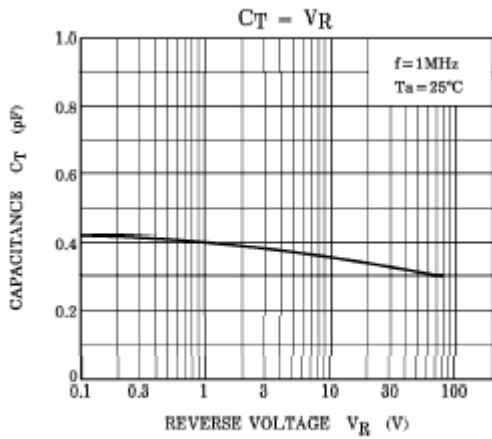
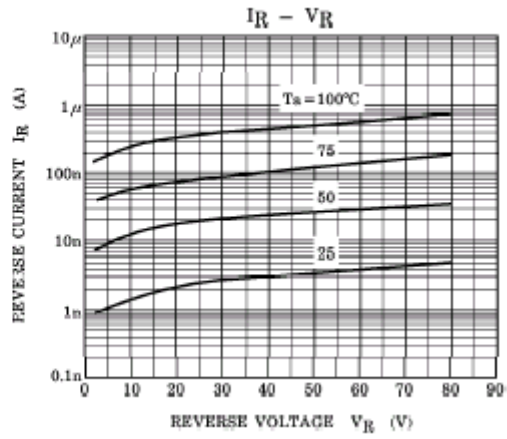
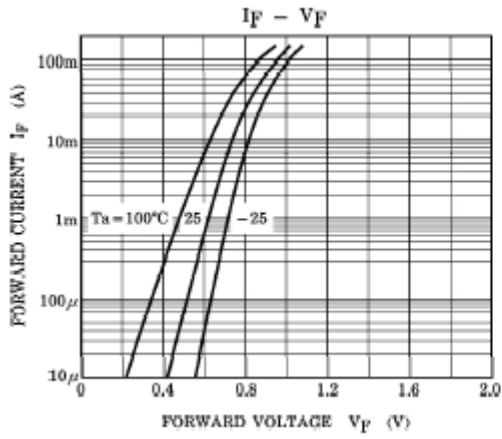

## SEMTECH ELECTRONICS LTD.

(Subsidiary of Semtech International Holdings Limited, a company listed on the Hong Kong Stock Exchange, Stock Code: 724)



ISO/TS 16949 : 2002  
Certificate No. 05103



ISO 14001  
Certificate No. 7116



ISO 9001 : 2000  
Certificate No. 550-1559-04-002-04

# 1SS352

## PACKAGE OUTLINE

Plastic surface mounted package; 2 leads

SOD-323

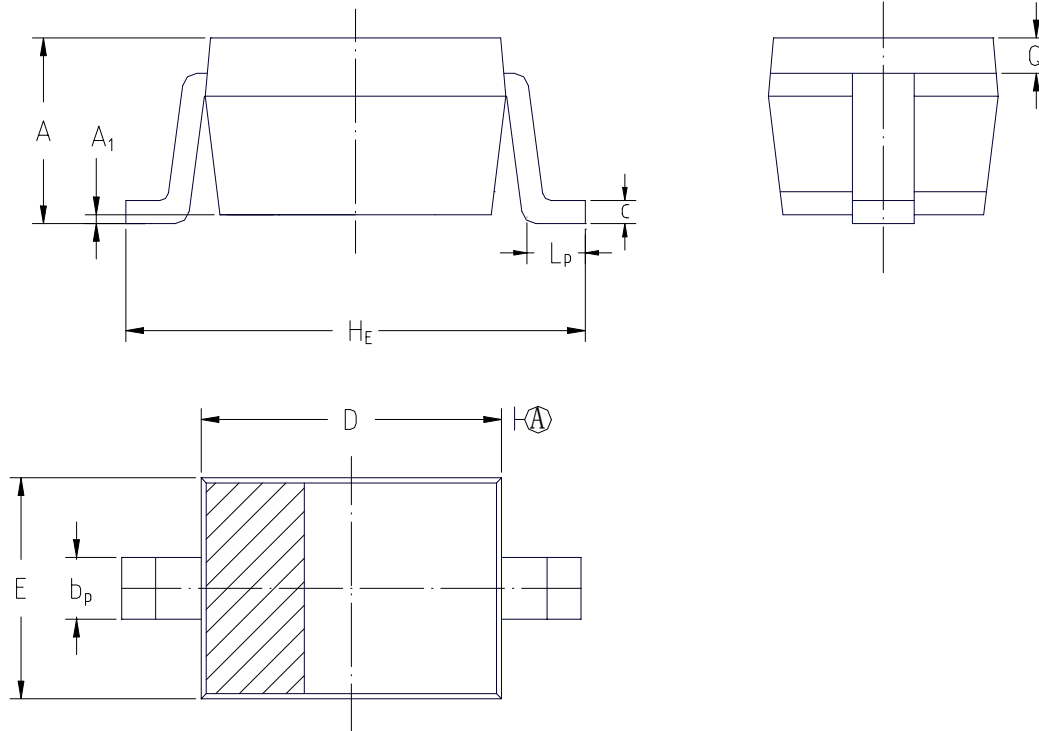

UNIT	A	A <sub>1</sub>	b <sub>p</sub>	c	D	E	H <sub>E</sub>	L <sub>p</sub>	Q
mm	1.10 0.80	0.1 0	0.40 0.25	0.15 0.00	1.80 1.60	1.35 1.15	2.80 2.30	0.50 0.10	0.15 REF.

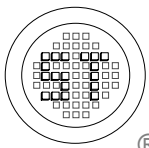

## SEMTECH ELECTRONICS LTD.

(Subsidiary of Semtech International Holdings Limited, a company listed on the Hong Kong Stock Exchange, Stock Code: 724)



ISO/TS 16949 : 2002  
Certificate No. 05103



ISO 14001  
Certificate No. 7116



ISO 9001 : 2000  
Certificate No. 550-159-04-02-04

Dated : 30/10/2004