

1SS315

SILICON EPITAXIAL SCHOTTKY PLANAR DIODE

APPLICATIONS

- UHF Band Mixer Applications

PINNING

| PIN | DESCRIPTION |
|-----|-------------|
| 1 | Cathode |
| 2 | Anode |

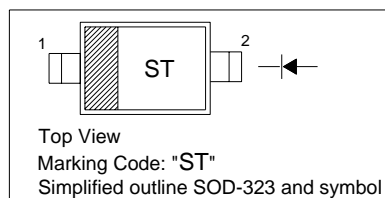

Absolute Maximum Ratings ($T_a = 25\text{ }^{\circ}\text{C}$)

| Characteristics | Symbol | Limits | Unit |
|---------------------------|-----------|--------------|------|
| Peak reverse voltage | V_{RM} | 5 | V |
| Forward current | I_F | 30 | mA |
| Junction temperature | T_J | 125 | ? |
| Storage temperature range | T_{stg} | -55 ... +125 | ? |

Electrical Characteristics ($T_a = 25\text{ }^{\circ}\text{C}$)

| Characteristics | Symbol | Min | Typ | Max | Unit | Test Conditions |
|-------------------|--------|-----|------|-----|---------------|--|
| Forward voltage | V_F | - | 0.25 | - | V | $I_F = 2\text{ mA}$ |
| Reverse current | I_R | - | - | 25 | μA | $V_R = 0.5\text{ V}$ |
| Forward current | I_F | 30 | - | - | mA | $V_F = 0.5\text{ V}$ |
| Total capacitance | C_T | - | 0.6 | - | pF | $V_R = 0.2\text{ V}, f = 1\text{ MHz}$ |

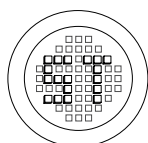

®

РАДИОТЕХ

Тел.: (495) 795-0805
Факс: (495) 234-1603
Эл. почта: info@rct.ru
Веб: www.rct.ru

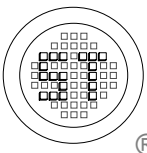
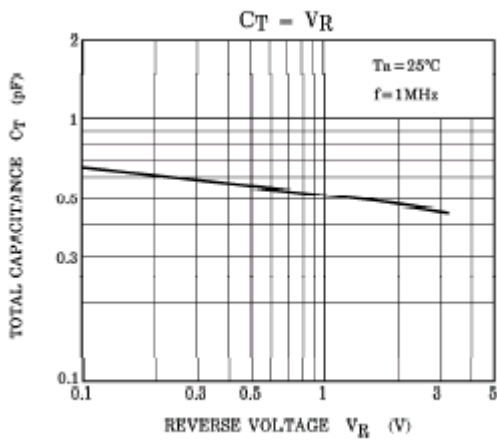
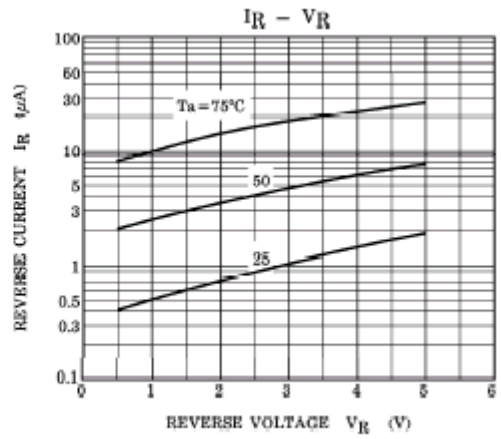
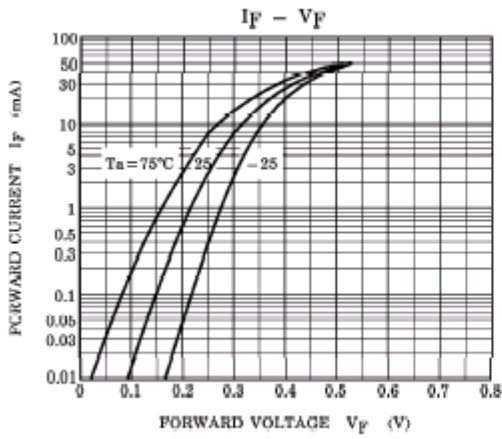

SEMTECH ELECTRONICS LTD.

(Subsidiary of Semtech International Holdings Limited, a company listed on the Hong Kong Stock Exchange, Stock Code: 724)



ISO/TS 16949 : 2002
Certificate No. 05103



ISO 14001
Certificate No. 7116



ISO 9001 : 2000
Certificate No. 550-159-04-002-04

1SS315

PACKAGE OUTLINE

Plastic surface mounted package; 2 leads

SOD-323

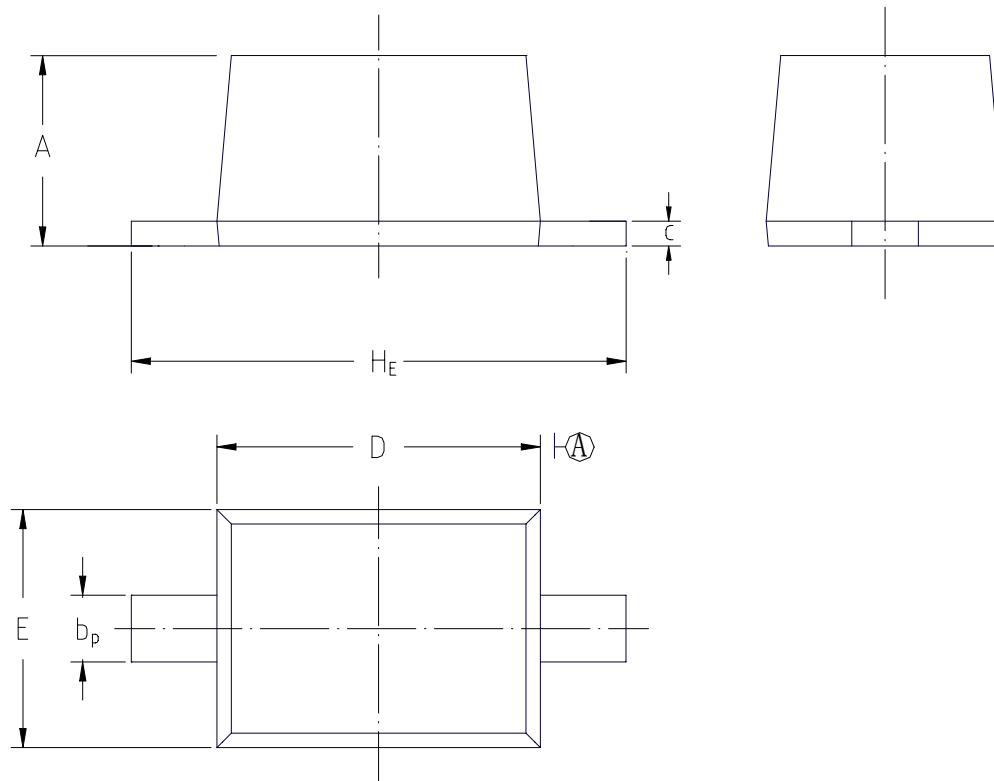

| UNIT | A | b _p | c | D | E | H _E |
|------|--------------|----------------|--------------|--------------|--------------|----------------|
| mm | 1.10 0.80 | 0.40 0.25 | 0.15 0.00 | 1.80 1.60 | 1.35 1.15 | 2.80 2.30 |

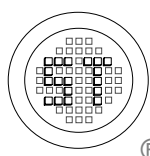

SEMTECH ELECTRONICS LTD.

(Subsidiary of Semtech International Holdings Limited, a company listed on the Hong Kong Stock Exchange, Stock Code: 724)



ISO/TS 16949 : 2002
Certificate No. 05103



ISO 14001
Certificate No. 7116



ISO 9001 : 2000
Certificate No. 550-1559-04-002-04

Dated : 30/10/2004