

# 1SS314

## SILICON EPITAXIAL PLANAR DIODE

### FEATURES

- Small package
- Small total capacitance:  $C_T = 1.2\text{pF}(\text{max})$
- Low series resistance:  $r_s = 0.5\Omega$  (typ.)

### PINNING

PIN	DESCRIPTION
1	Cathode
2	Anode

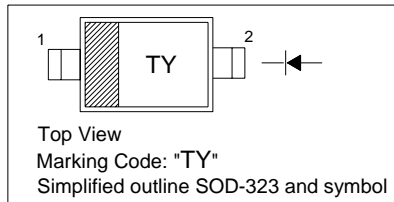

### APPLICATIONS

- VHF Tuner Band Switch Applications

### Absolute Maximum Ratings ( $T_a = 25\text{ }^\circ\text{C}$ )

Characteristics	Symbol	Limits	Unit
Reverse voltage	$V_R$	30	V
Forward current	$I_F$	100	mA
Junction temperature	$T_J$	125	?
Storage temperature range	$T_{stg}$	-55 ... +125	?

### Electrical Characteristics ( $T_a = 25\text{ }^\circ\text{C}$ )

Characteristics	Symbol	Min	Typ	Max	Unit	Test Conditions
Forward voltage	$V_F$	-	-	0.85	V	$I_F = 2\text{mA}$
Reverse current	$I_R$	-	-	0.1	$\mu\text{A}$	$V_R = 15\text{V}$
Reverse voltage	$V_R$	30	-	-	V	$I_R = 1\mu\text{A}$
Total capacitance	$C_T$	-	0.7	1.2	pF	$V_R = 6\text{V}, f = 1\text{MHz}$
Series resistance	$R_S$	-	0.5	0.9	$\Omega$	$I_F = 2\text{mA}, f = 100\text{MHz}$

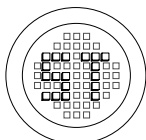

®

**РАДИОТЕХ**

Тел.: (495) 795-0805  
Факс: (495) 234-1603  
Эл. почта: info@rct.ru  
Веб: www.rct.ru

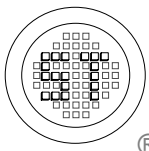
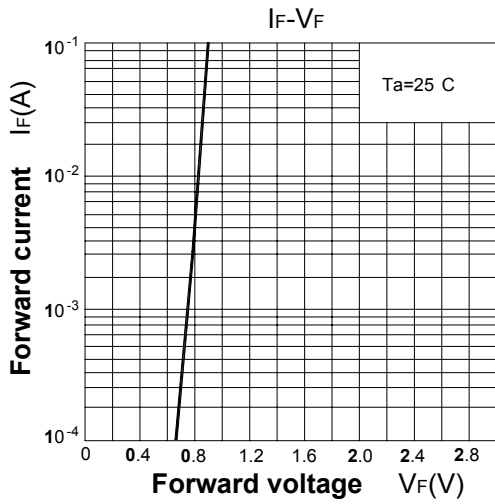
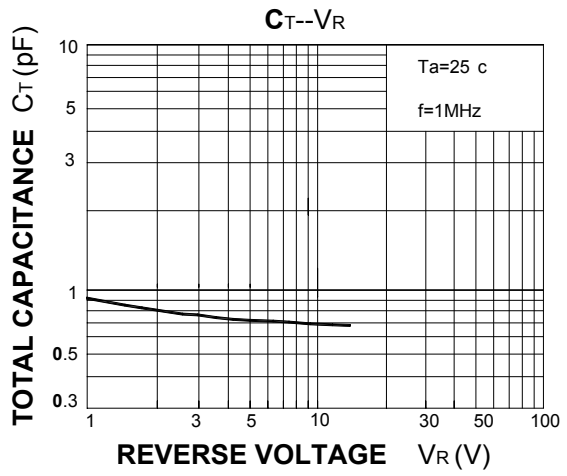
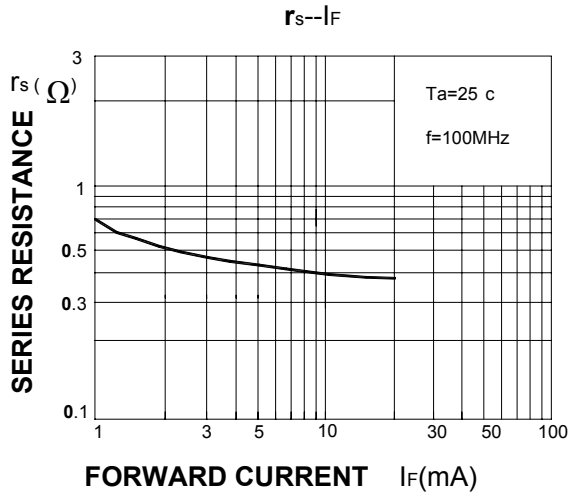

## SEMTECH ELECTRONICS LTD.

(Subsidiary of Semtech International Holdings Limited, a company listed on the Hong Kong Stock Exchange, Stock Code: 724)



ISO/TS 16949 : 2002  
Certificate No. 05103



ISO 14001  
Certificate No. 7116



ISO 9001 : 2000  
Certificate No. 550-1559-04-002-04

# 1SS314

## PACKAGE OUTLINE

Plastic surface mounted package; 2 leads

SOD-323

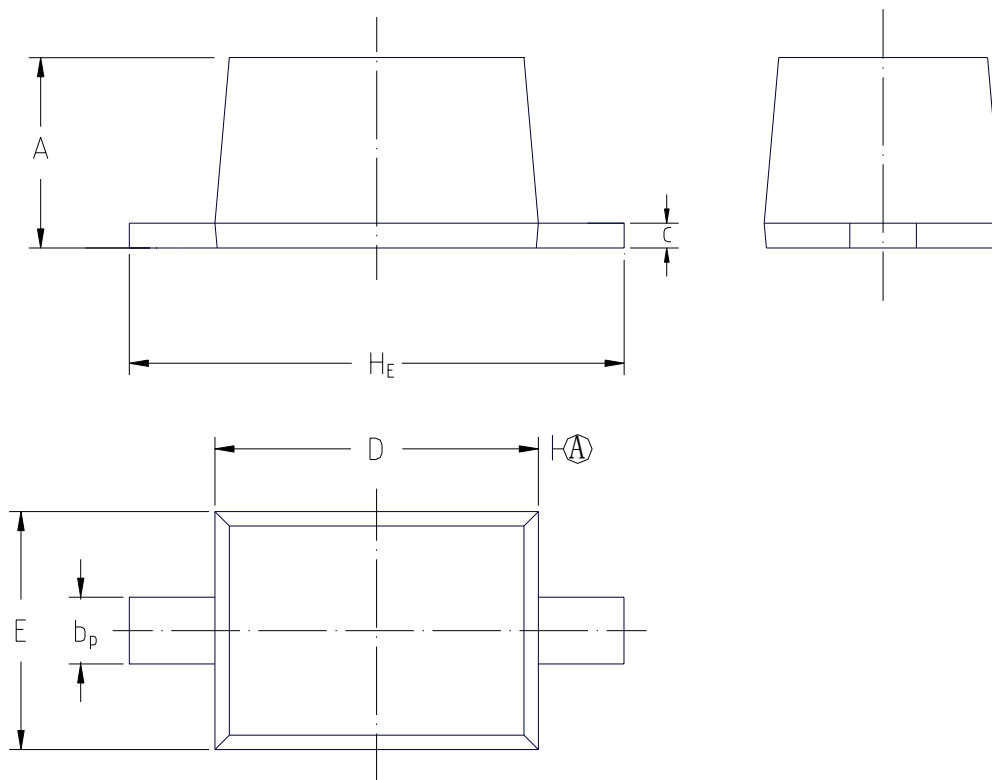

UNIT	A	$b_p$	c	D	E	$H_E$
mm	1.10 0.80	0.40 0.25	0.15 0.00	1.80 1.60	1.35 1.15	2.80 2.30

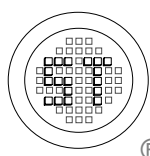

## SEMTECH ELECTRONICS LTD.

(Subsidiary of Semtech International Holdings Limited, a company listed on the Hong Kong Stock Exchange, Stock Code: 724)



ISO/TS 16949 : 2002  
Certificate No. 05103



ISO 14001  
Certificate No. 7116



ISO 9001 : 2000  
Certificate No. 550-1559-04-002-04

Dated : 30/08/2004