

# CHEAPE TECHNOLOGY INTERNATIONAL LIMITED.

## 60K2A2H Ni-Cd BUTTON CELL

### TECHNICAL DATA

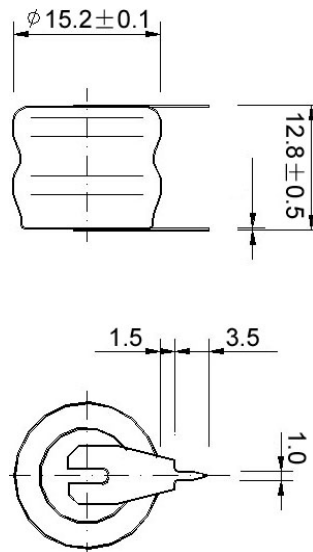

Model	Voltage	Capacity	Recommended Trickle Charge Current	Nominal Charge Current	Normal Charging Time	Nominal Discharge Current	Weight
60K2A2H	2.4V	60mAh	1.8~3mA	6mA	14~16h	12mA	6.6g

### TECHNICAL CHARACTERISTICS

TYPICAL CHARGE CURVE (6mA)

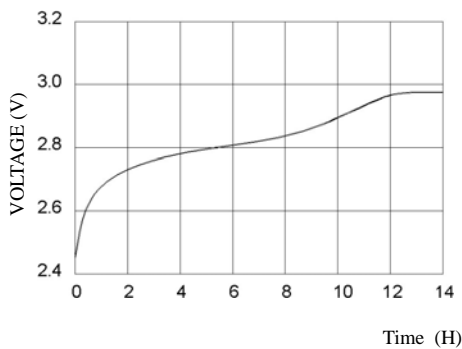

TYPICAL DISCHARGE CURVE (12mA)

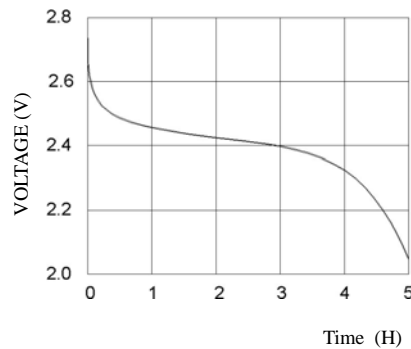

CYCLE LIFE CURVE

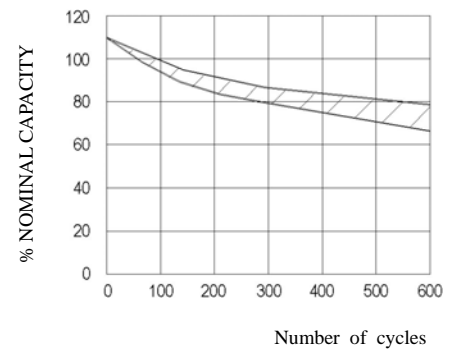

TYPICAL CHARGE CURVE AT VARIOUS CURRENTS

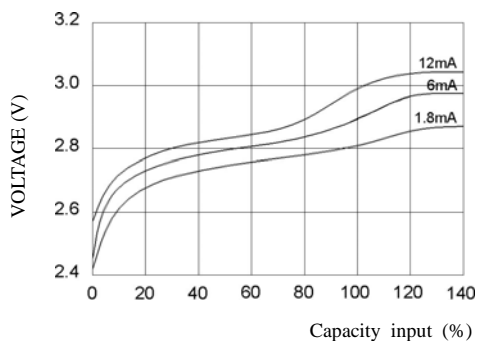

DISCHARGE CURVE AT VARIOUS TEMPERATURES (12mA)

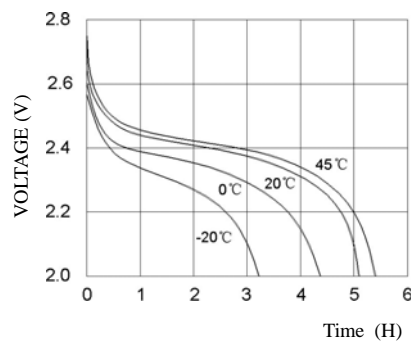

SELF DISCHARGE RATE AT VARIOUS TEMPERATURES

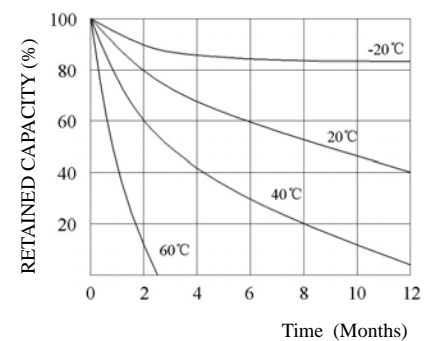

# TECHNICAL INFORMATION

## 1. APPLICATION

This specification applies to the Ni-Cd batteries

Model : 60K2A2H

## 2. CELL AND TYPE

2.1 Cell : Sealed Ni-Cd Button Cell

2.2 Type : Button type

2.3 Size type : 2.4V

## 3. RATINGS

3.1 Nominal voltage : 2.4V

3.2 Nominal capacity : 60mAh/0.2CmA

3.3 Typical weight : 6.6g

3.4 Standard charge : 6mA × 14hours

3.5 Rapid charge : 12mA × 6hours

Trickle current : 1.8mA

3.6 Discharge cut-off voltage: 2.0V

3.7 Temperature range for operation (Humidity: Max.85%)

Standard charge 0~+45°C

Rapid charge +10~+45°C

Trickle charge 0~+45°C

Discharge -10~+45°C

3.8 Temperature range for storage (Humidity: Max.85%)

Within 2 years -20~+35°C

Within 6 months -20~+45°C

Within a month -20~+45°C

Within a week -20~+55°C

## 4. ASSEMBLY & DIMENSIONS

Per attached drawing

## 5. PERFORMANCE

### 5.1 TEST CONDITIONS

The test is carried out with new batteries (within a month after delivery)

ambient conditions

Temperature: +25 ± 5°C

Humidity: 60 ± 20%

Note 1

Standard charge : 6mA × 14hours

Standard discharge : 0.2C to 2.0V

### 5.2 TEST METHOD & PERFORMANCE

Test	Unit	Specification	Conditions	Remarks
Capacity	mAh	≥60	Standard Charge/discharge	Up to 3 cycles Are allowed
Open Circuit Voltage(OCV)	Voltage (V)	≥2.6	After 1 hour standard Charge	
Internal Impedance	mΩ /cell	≤1000	Upon fully charge (1KHz)	

High rate Discharge(0.5C)	Minute	≥60	Standard charge Before discharge	
Discharge Current	mA	30	Maximum continuous Discharge current	
Over charge		No leakage Not explosion	1.8mA(0.03C) charge one year	
Charge Retention	mAh	48	Standard charge; Storage: 28 days; Standard discharge	
Cycle Life	Cycle	≥500	IEC285(1993)4.4.1	
Leakage		No leakage nor Deformation	Fully charge at 6mA, Stand 14 days	

Note 2 IEC285(1993)4.4.1 cycle life

Cycle number	Charge	Rest	Discharge
1-50	6mA for 14h		12mA for 5h

50 cycles of test as in the following table condition is repeated, The discharge time of the 100<sup>th</sup>,200<sup>th</sup>,400<sup>th</sup>,500<sup>th</sup> is more than 5 hours. (Ambient temperature is 20±5°C)

### 5.3 Humidity

The battery shall not leak during the 14 days which it is submitted to the condition of a temperature of 33±3°C and a relative humidity of 80±5%

## 6. OTHERS

6.1 We recommend you to set the cut-off voltage at 1.0V/cell

6.2 If the cut-off voltage is above 1.1V/cell, the battery may be underutilized resulting insufficient use of the available capacity

6.3 If it is below 1.0V/cell, the battery may have discharge or reverse charge to the cell

## 7. PRECAUTION

The cells shall be delivered in charged condition. Before testing or using, the cell shall be discharged at 20±5°C at a constant current of 0.2CmA to a final voltage of 1.0V/cell.

7.1 Avoid throwing cells into a fire or attempting to disassemble them.

7.2 Avoid short circuiting the cells.

7.3 Avoid direct solidarity to cells.

7.4 Observe correct polarity when connecting.

7.5 Do not charge with more than our specified current.

7.6 Use cells only within the specified working temperature range.

7.7 Store cells in dry and cool place.