

# Poly-carbonmonofluoride Lithium Coin Batteries: Individual Specifications

## BR2020

Dimensions(mm)

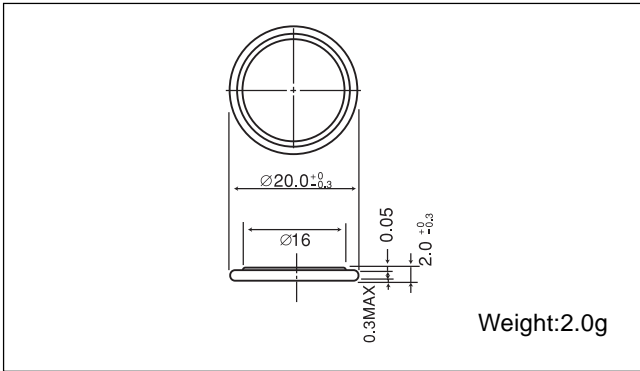

Specification

Nominal voltage (V)	3
Nominal capacity (mAh)	100
Continuous standard load (mA)	0.03
Operating temperature (C)	-30 ~ +80

Temperature Characteristics

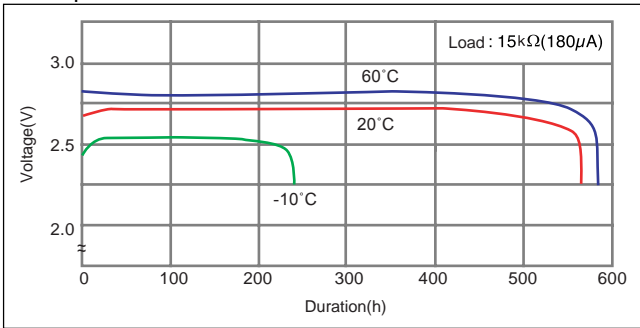

Operating voltage vs. load resistance(voltage at 50% discharge depth)

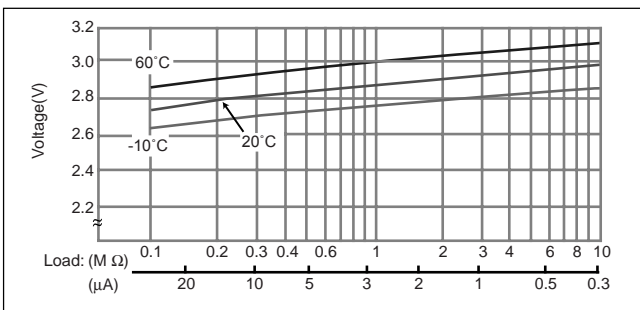

Capacity vs. load resistance

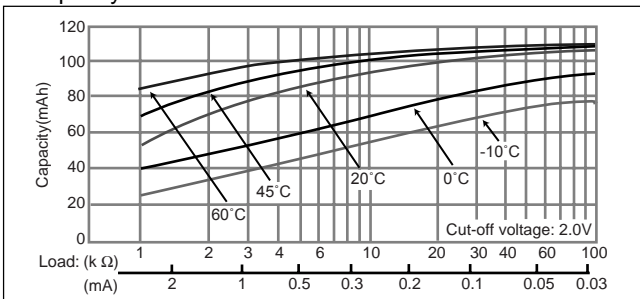

## BR2032

Dimensions(mm)

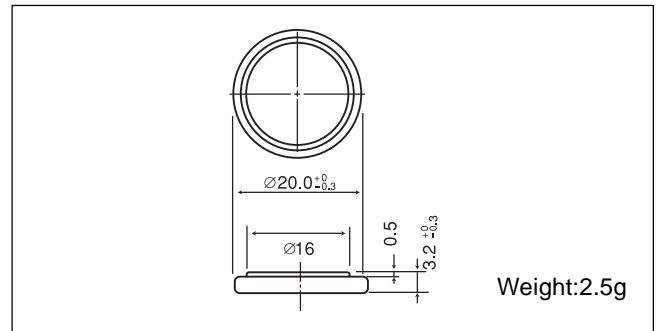

Specification

Nominal voltage (V)	3
Nominal capacity (mAh)	190
Continuous standard load (mA)	0.03
Operating temperature (C)	-30 ~ +80

Temperature Characteristics

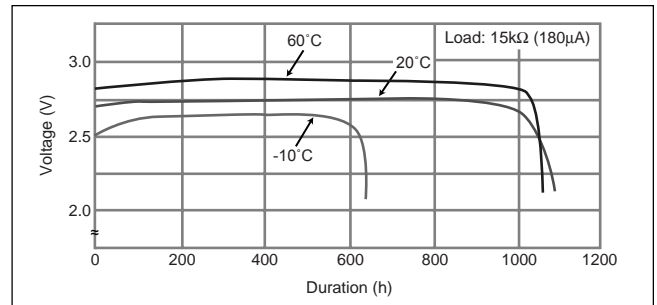

Operating voltage vs. load resistance(voltage at 50% discharge depth)

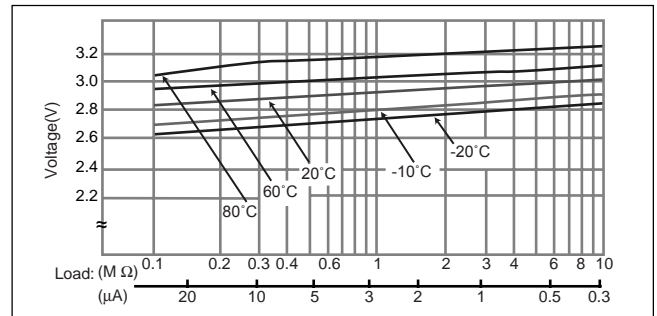

Capacity vs. load resistance

