

Poly-carbonmonofluoride Lithium Coin Batteries: Individual Specifications

BR1225

Dimensions(mm)

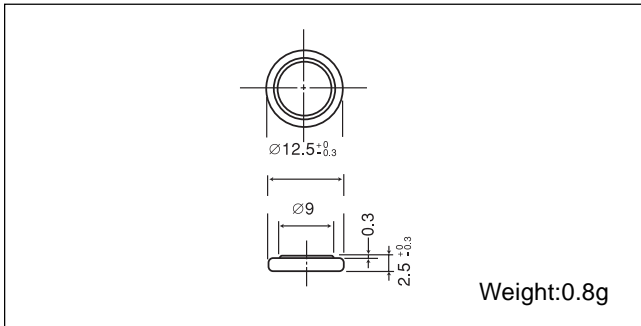

Specification

Nominal voltage (V)	3
Nominal capacity (mAh)	48
Continuous standard load (mA)	0.03
Operating temperature (C)	-30 ~ +80

Temperature Characteristics

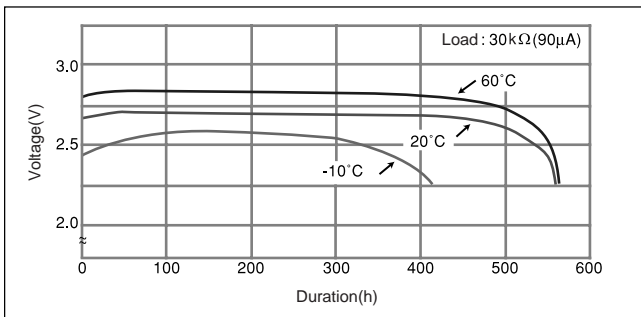

Operating voltage vs. load resistance (voltage at 50% discharge depth)

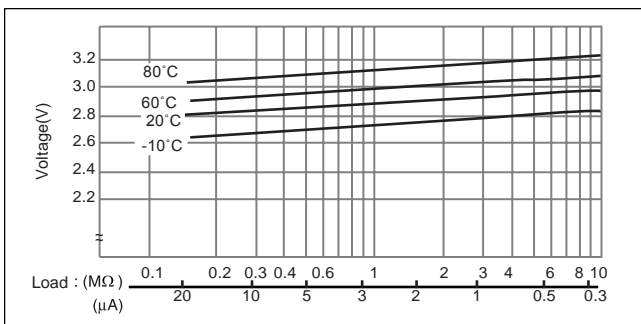

Capacity vs. load resistance

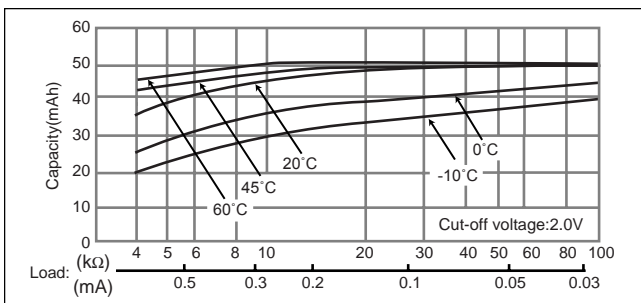

BR1616

Dimensions(mm)

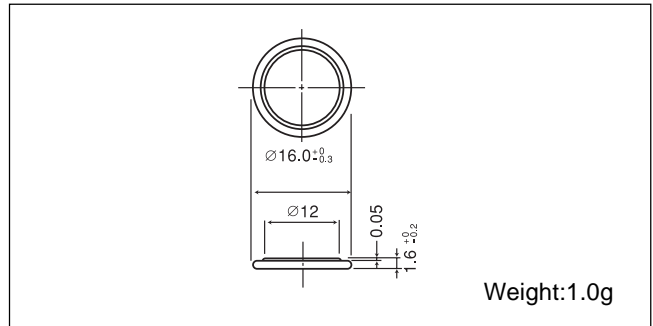

Specification

Nominal voltage (V)	3
Nominal capacity (mAh)	48
Continuous standard load (mA)	0.03
Operating temperature (C)	-30 ~ +80

Temperature Characteristics

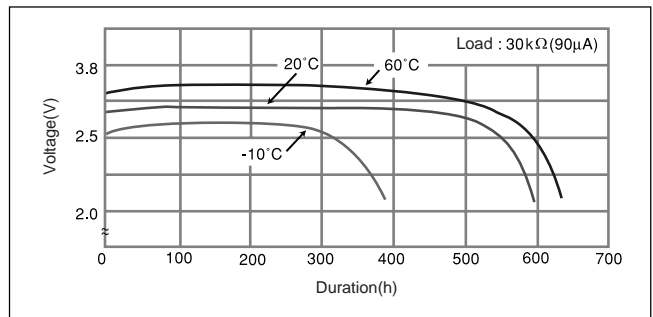

Operating voltage vs. load resistance (voltage at 50% discharge depth)

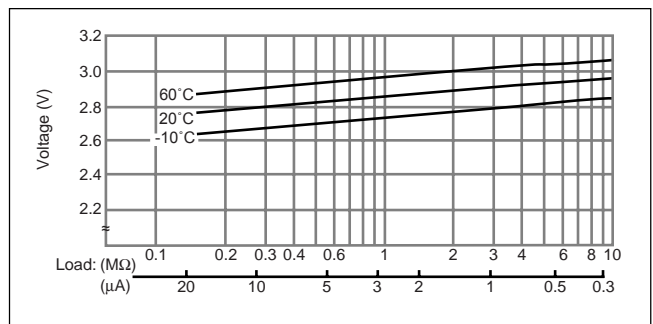

Capacity vs. load resistance

