



HONGFA RELAY

● GENERAL RELAY

Дистрибьютор реле «HONGFA» в России:
ГК РАДИОТЕХ (495) 795-08-05
www.rct.ru

HONGFA RELAY



GENERAL RELAY



www.hongfa.com



RoHS compliant

ISO9001 ISO/TS16949 ISO14001 OHSAS18001 IECQ QC080000 CERTIFIED

PROFESSIONAL RELAY MANUFACTURER

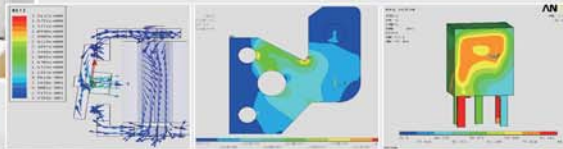



COMPANY INTRODUCTION

HONGFA

HONGFA (Stock code: 600885, SSE) always conforms to its business philosophy -- "Never rest on our laurels, make more progress" and uses this philosophy as the basis of its operational policy -- "Market-oriented concept, win by high quality". The following companies are fully or partially owned by HONGFA-- Zhangzhou Hongfa, Jinhai, Xi'an Hongfa, Hongyuanda, Hongfa Automotive Electronics, Hongfa Signal Electronics, Hongfa Hermetically Sealed Relays, Hongfa Power Electronics, Hongzhou, Hongfa Wufeng, Hongfa Electrical Safety & Control, Hongfa Electric, Jinyue, Jinbo, Jinghe, Hongfa Industrial Robot, Hongfa Precision Machinery, Shanghai Hongfa, Beijing Hongfa, Sichuan Hongfa (Sales), Hongfa Hongkong, Hongfa Europe GmbH, Hongfa America Inc., KG Technologies Inc. HONGFA products include as relays, low-voltage devices, switchgears, precise parts, automatic equipment, etc..

HONGFA has a wealth of experience in relays development and manufacturing after many years of hard work. HONGFA is now the leading relays manufacturer in China and is ranked No. 1 in the industry for overall economic efficiency. HONGFA has also become one of the leading relays sellers and manufacturers in the world. From 1995, HONGFA has continuously ranked among 'China Top-100 Electronic Components Enterprises' with a current position of the 9th and has received many awards: HONGFA has recognized as one of the China Top 100 Enterprises Of Electronic Information for the first time as the first finalist in relay, in 2014. HONGFA is authorized as "the Advanced Enterprise to implement High Technology in Torch Plan" by the Ministry of Science and Technology of PRC. HONGFA has been awarded "National Export-Oriented Enterprise of Automotive Components" by the Ministry of Commerce of PRC and National Development and Reform Commission. HONGFA is the only company being awarded this honor in the Chinese relay industry.

HONGFA has a full set of quality assurance systems including ISO9001, ISO/TS16949, ISO14001, OHSAS18001, GJB9001A, IECQ QC 080000. HONGFA has also been honorably awarded "High Quality Product exempt from National Inspection". HONGFA products are UL/CUL, VDE, TÜV, CQC and CCC approved. With high performance, top quality, competitive price and excellent technical services, HONGFA Relays have become the most perfect choice for the customers.

Since the establishment, HONGFA has been focusing on technology innovation. HONGFA has introduced the most advanced relays manufacturing technology and equipment available worldwide into the factories to upgrade our technology level and the product quality. HONGFA engineers use 3-D CAD in new product development and mould tooling design. The technology and the equipment of all the mould tooling, parts manufacturing and products assembly and the production environment are in the leading position in Chinese relays industry. HONGFA Testing Centre is the biggest relays testing and analyzing laboratory with the most advanced technology in China. HONGFA Testing Centre is approved by CNAS and it is approved by America UL as a CTDP lab. It is approved by Germany VDE as a TDAP lab -For VDE's TDAP lab, there is only one in China and only six in the world. At the same time, HONGFA Testing Centre is also the unique partnership for VDE in electronic components in the world. The testing capability on RoHS compliance in the chemistry analysis laboratory is also approved by CNAS, which means that Hongfa is able to supply to the customers accurate, credible and authorized inspection data and test reports.

HONGFA has a wide range of relays, including Signal relays, Power relays, Automotive relays & modules, Latching relays, HVDC relays, Industrial relays, Safety relays and Hermetically sealed relays. The company has the annual production capacity of 1.5 billion pieces of relays.

Now HONGFA has become the world leading relays research and manufacturing base. Hongfa People are looking forward to growing, developing and prospering with all the partners and customers worldwide together.

PERSEVERE FOR PROGRESS.

STRIVE FOR EXCELLENCE!

WE ARE CONTROL EXPERT



Hongfa is a professional relay manufacturer and has a wide range of relays. Hongfa relays are UL/CUL, VDE, TÜV, CQC and CCC approved. They are widely used in those fields like industrial control, automotive, telecom equipment, home appliances, metering instruments, security and alarm systems, medical appliances and aviation.

HONGFA PRODUCTS:



CONTENTS

Company introduction	color page
Quick index	2
Classification	2
Alphabetical	3
Selection guide	4
Selection chart	8
Relay data sheets	37
Signal Relay	37
Power Relay	77
Comparative list between the old and new ordering type	331
Cross reference guide	333
Packing list	339
Explanation to terminology and guidelines of relay	343

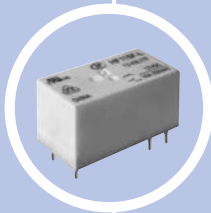
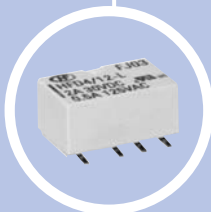

Notice

Dear Sir or Madam,

Many thanks for your choosing Hongfa products!

Please note the following important information:

1. Since all Hongfa products are RoHS compliant, we will remove the special code (551) or (555) from our current ordering types from April 1st, 2008. Please place your orders according to the newest ordering types. In the meantime, we hereby declare that all Hongfa products are RoHS compliant, no matter suffix (551) or (555) is used or not.
2. We have started to switch the old ordering type to the new one since 2005 (For example, the old ordering type is JQX-115F and the new one is HF115F). At the moment we strongly recommend that you should use the new ordering type for your orders. Please refer to "Comparative list between the old and new ordering type".
3. For the plastic sealed type, after welding, the relay should be cooled down below 40°C naturally, then start washing and surface handling, the temperature of washing liquid and surface handling cleanser should be controlled also below 40°C. When washing, please do not use washing liquid such as ultrasonic, gasoline, Freon etc. which may affect the relay structure and environment. For covers made from PC material, please prevent from contamination by some organic solvents; otherwise it is likely to bring to a chemic refection which leads to bulging or crack.

Further more, all the data sheets are subject to change without notice. For updated information please visit our website: www.hongfa.com.

Should you have any question, please feel free to contact us.

QUICK INDEX (Classification)

Signal Relay	37	HF115F-T/TH	178
HFD23	38	HF115F-H	181
HFD41/HFD41A	41	HF115F-I	184
HFD27	44	HF115F-Q	187
HFD2	47	HF115F-S	190
HFD3	51	HF115F-L 1 pole	192
HFD3-V	57	HF115F-L 2 pole	195
HFD31	62	HF115F-LS	198
HFD4	67	HF115FP	201
HFD42	72	HF115FK	204
		HF115FK-T	207
		HF158F	210
Power Relay	77	HF158F-V	213
HF49FD	78	HF141FF	216
HF41F	81	HF14FF	219
HF46F	85	HF14FW	222
HF46F-G	88	HF140FF	225
HF42F	91	HF25F	229
HF32FA	94	HF62F	233
HF32FA-T	97	HF102F	236
HF32FA-G	100	HF161F	239
HF32FV	103	HF161F-W	242
HF32FV-G	106	HF160F	245
HF32F	109	HF166F	248
HF32F-G	112	HF37F	251
HF33F	114	HF165FD	254
HF36F	117	HF165FD-G	258
HF36FD	120	HF165F	261
HF162F	122	HF105F-1	264
HF8	124	HF105F-2	270
HF3FA	127	HF105F-4	274
HF3FD	130	HF105F-5	278
HF3FF	133	HF2100	282
HF3F-L	136	HF2110/HF2120	286
HF3FF-M	139	HF2150	292
HF7FF	142	HF2160	296
HF7FD	145	HF116F-1	300
HF21FF	148	HF116F-2	304
HF152F	151	HF116F-3	308
HF152FD	154	HF116F-G	312
HF7520	157	HF116F-80	316
HF163F-L	161	HF92F	318
HFE7	164	HF84F	322
HF118F	168	HF94F	324
HF115F	171	HF8565	327
HF115F-A	175		



HONGFA RELAY

ISO9001、ISO/TS16949、ISO14001、OHSAS18001、IECQ QC 080000 CERTIFIED

QUICK INDEX (Alphabetical)

HF

HF3F-L	136
HF3FA	127
HF3FD	130
HF3FF	133
HF3FF-M	139
HF7FD	145
HF7FF	142
HF8	124
HF14FF	219
HF14FW	222
HF21FF	148
HF25F	229
HF32F	109
HF32F-G	112
HF32FA	94
HF32FA-T	97
HF32FA-G	100
HF32FV	103
HF32FV-G	106
HF33F	114
HF36F	117
HF36FD	120
HF37F	251
HF41F	81
HF42F	91
HF46F	85
HF46F-G	88
HF49FD	78
HF62F	233
HF84F	322
HF92F	318
HF94F	324
HF102F	236
HF105F-1	264
HF105F-2	270
HF105F-4	274
HF105F-5	278
HF115F	171
HF115F-A	175
HF115F-H	181
HF115F-I	184
HF115F-L 1 pole	192
HF115F-L 2 pole	195
HF115F-LS	198
HF115F-Q	187

HF115F-S	190
HF115F-T/TH	178
HF115FP	201
HF115FK	204
HF115FK-T	207
HF116F-1	300
HF116F-2	304
HF116F-3	308
HF116F-80	316
HF116F-G	312
HF118F	168
HF140FF	225
HF141FF	216
HF152F	151
HF152FD	154
HF158F	210
HF158F-V	213
HF160F	245
HF161F	239
HF161F-W	242
HF162F	122
HF163F-L	161
HF165F	261
HF165FD	254
HF165FD-G	258
HF166F	248
HF2100	282
HF2110/HF2120	286
HF2150	292
HF2160	296
HF7520	157
HF8565	327

HFD

HFD2	47
HFD23	38
HFD27	44
HFD3	51
HFD31	62
HFD3-V	57
HFD4	67
HFD41/41A	41
HFD42	72

HFE

HFE7	164
------	-----



HONGFA RELAY

ISO9001, ISO/TS16949, ISO14001, OHSAS18001, IECQ QC 080000 CERTIFIED

SELECTION GUIDE

Terminals		Coil		Relay Type	Contact Form	Page	Switching Current	[A]	
PCB	QC Plug-in/Other	DC	AC						
				HF37F	1A (SPST-NO)	251			
				HF165FD		254			
				HF105F-1		264			
				HF105F-2		270			
				HF105F-4		274			
				HF105F-5		278			
				HF2100		282			
				HF2110/HF2120		286			
				HF2150		292			
				HF2160		296			
				HF116F-1		300			
				HF116F-2		304			
				HF116F-3		308			
				HF165F		261			
				HF165FD-G		258			
				HF116F-G		312			
				HF116F-80		316			
				HF42F	2A	91			
				HFE7		164			
				HF115F		171			
				HF115F-A		175			
				HF115F-L		195			
				HF115FK		204			
				HF140FF		225			
				HF116F-1		300			
				HF116F-2		304			
				HF116F-3		308			
				HF92F		318			
				HF116F-G		312			
				HFD23	1C (SPDT)	38			
				HF32FA		94			
				HF32F		109			
				HFD41/HFD41A		41			
				HF41F		81			
				HF8		124			
				HF84F		322			
				HF33F		114			
				HF36F		117			
				HF3FA		127			
				HF3FD		130			
				HF3FF		133			
				HF3F-L		136			
				HF7FF		142			
				HF21FF		148			
				HF7520		157			
				HF118F		168			
				HF115F-H		181			
				HF141FF		216			
HF14FF	219								

How to use the table: Please select the CONTACT FORM. Then choose the relay according to SWITCHING CURRENT and OTHERS (for instance, coil voltage, terminal style, etc.).

SELECTION GUIDE

Terminals				Coil		Relay Type	Contact Form	Page	Switching Current [A]											
PCB	QC	Plug-in	Other	DC	AC				0	5	10	15	20	25	30	40	60	80	100	200
						HF7FD	1C (SPDT)	145	[Bar chart showing switching current for HF7FD]											
						HF3FF-M		139	[Bar chart showing switching current for HF3FF-M]											
						HF152F		151	[Bar chart showing switching current for HF152F]											
						HF115F		171	[Bar chart showing switching current for HF115F]											
						HF115F-A		175	[Bar chart showing switching current for HF115F-A]											
						HF115F-T/TH		178	[Bar chart showing switching current for HF115F-T/TH]											
						HF115F-I		184	[Bar chart showing switching current for HF115F-I]											
						HF115F-L		192	[Bar chart showing switching current for HF115F-L]											
						HF115FP		201	[Bar chart showing switching current for HF115FP]											
						HF115FK		204	[Bar chart showing switching current for HF115FK]											
						HF115FK-T		207	[Bar chart showing switching current for HF115FK-T]											
						HF158F		210	[Bar chart showing switching current for HF158F]											
						HF152FD		154	[Bar chart showing switching current for HF152FD]											
						HF94F		324	[Bar chart showing switching current for HF94F]											
						HF14FW		222	[Bar chart showing switching current for HF14FW]											
						HF165FD		254	[Bar chart showing switching current for HF165FD]											
						HF105F-1		264	[Bar chart showing switching current for HF105F-1]											
						HF105F-2		270	[Bar chart showing switching current for HF105F-2]											
						HF105F-4		274	[Bar chart showing switching current for HF105F-4]											
						HF105F-5		278	[Bar chart showing switching current for HF105F-5]											
						HF2100	282	[Bar chart showing switching current for HF2100]												
						HF2110/HF2120	286	[Bar chart showing switching current for HF2110/HF2120]												
						HF2150	292	[Bar chart showing switching current for HF2150]												
						HF2160	296	[Bar chart showing switching current for HF2160]												
						HFD31	2C	62	[Bar chart showing switching current for HFD31]											
						HFD27		44	[Bar chart showing switching current for HFD27]											
						HFD3		51	[Bar chart showing switching current for HFD3]											
						HFD3-V		57	[Bar chart showing switching current for HFD3-V]											
						HFD4		67	[Bar chart showing switching current for HFD4]											
						HFD42		72	[Bar chart showing switching current for HFD42]											
						HFD2		47	[Bar chart showing switching current for HFD2]											
						HF115F		171	[Bar chart showing switching current for HF115F]											
						HF115F-A		175	[Bar chart showing switching current for HF115F-A]											
						HF115F-L		195	[Bar chart showing switching current for HF115F-L]											
						HF115FP	201	[Bar chart showing switching current for HF115FP]												
						HF115FK	204	[Bar chart showing switching current for HF115FK]												
						HF140FF	225	[Bar chart showing switching current for HF140FF]												
						HF92F	318	[Bar chart showing switching current for HF92F]												
						HFE7	1B (SPST-NC)	164	[Bar chart showing switching current for HFE7]											
						HF118F		168	[Bar chart showing switching current for HF118F]											
						HF115F-H		181	[Bar chart showing switching current for HF115F-H]											
						HF141FF		216	[Bar chart showing switching current for HF141FF]											
						HF21FF		148	[Bar chart showing switching current for HF21FF]											
						HF165FD		254	[Bar chart showing switching current for HF165FD]											
						HF105F-1		264	[Bar chart showing switching current for HF105F-1]											
						HF105F-2		270	[Bar chart showing switching current for HF105F-2]											
						HF105F-4		274	[Bar chart showing switching current for HF105F-4]											
						HF105F-5		278	[Bar chart showing switching current for HF105F-5]											
						HF2100	282	[Bar chart showing switching current for HF2100]												
						HF2110/HF2120	286	[Bar chart showing switching current for HF2110/HF2120]												



How to use the table: Please select the CONTACT FORM. Then choose the relay according to SWITCHING CURRENT and OTHERS (for instance, coil voltage, terminal style, etc.).

SELECTION GUIDE

Terminals			Coil		Relay Type	Contact Form	Page	Switching Current	[A]
PCB	QC	Plug-in/Other	DC	AC					
		HF2150	1B (SPST-NC)	292					
		HF2160		296					
		HF115F		171					
		HF115F-A		175					
		HF84F		322					
		HF94F		324					
		HF115F-Q		187					
		HF14FW		222					
		HF8565		327					
						HFE7	2B	164	
HF115F	171								
HF115F-A	175								
		HFE7	1A+1B	164					
		HF94F		324					
		HF166F		248					

How to use the table: Please select the CONTACT FORM. Then choose the relay according to SWITCHING CURRENT and OTHERS (for instance, coil voltage, terminal style, etc.).

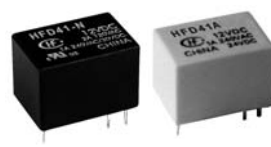
SIGNAL RELAY SELECTION CHART

Type	HFD23	HFD41/HFD41A	HFD27
Appearance			
Dimensions(L x W x H) mm	12.5 x 7.5 x 10.0	15.7 x 11.0 x 12.0	20.2 x 10.0 x 11.5
Features	<ul style="list-style-type: none"> • Max.4A switching capability • High sensitive: 150mW • Plastic sealed type available 	<ul style="list-style-type: none"> • 5A switching capability • 1 Form C configuration • Standard PCB layout • Plastic sealed and flux proofed types available 	<ul style="list-style-type: none"> • High switching capacity: 125VA/60W • Matching 16 pin IC socket • Epoxy plastic sealed for automatic wave soldering and cleaning • Bifurcated contacts

Contact Ratings

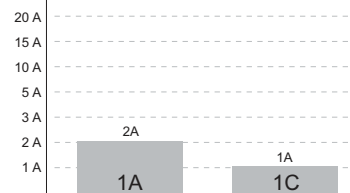
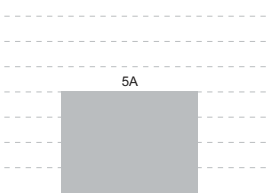
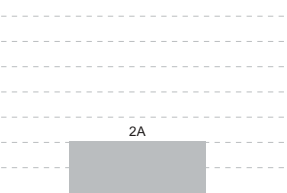
Contact Form	1A	1C	1C	2C
Contact Material	AgNi + Au plated		AgNi, AgCdO	AgNi + Au plated
Max. Switching Current (Res. load)				
Max. Switching Voltage	125VAC / 60VDC		240VAC / 30VDC	240VAC / 120VDC
Max. Switching Power	125VA / 60W	62.5VA / 30W	600VA / 30W	125VA / 60W
Rated Load (Resistive load)	1A 125VAC 2A 30VDC	0.5A 125VAC 1A 30VDC	1A 120VAC, 3A 120VAC 1A 240VAC/30VDC 2A 120VAC, 5A 120VAC	1A 125VAC 2A 30VDC

Coil Ratings

Rated Voltage	1.5VDC to 24VDC	3VDC to 24VDC	3VDC to 48VDC
Nominal Operating Power	0.15W, 0.2W	0.2W, 0.36W, 0.45W	0.15W to 0.58W

Specifications

Insulation Resistance	1000MΩ	100MΩ	1000MΩ
Dielectric Strength (Between coil and contacts)	1000VAC	1000VAC	1500VAC
Ambient Temperature	-40°C to 70°C	-25°C to 70°C	-40°C to 85°C
Operate / Release Time max.	5ms / 5ms	10ms / 5ms	7ms / 4ms
Mechanical Endurance min.	1 x 10 ⁷ OPS	1 x 10 ⁷ OPS	1 x 10 ⁸ OPS
Electrical Endurance min.	9 x 10 ⁴ OPS (1C: 0.5A 125VAC 1A: 1A 125VAC)	9.9 x 10 ⁴ OPS (at 1A 120VAC)	1 x 10 ⁵ OPS (at 1A 30VDC)

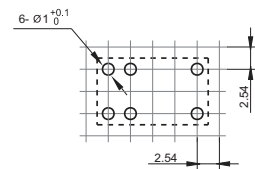
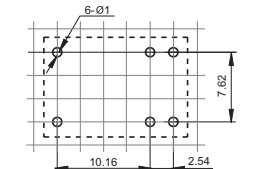
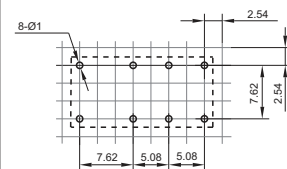
Layout (Bottom view)			
Terminal Type	PCB (DIP)	PCB (DIP)	PCB (DIP)
Approved Standards	UL/CUL CQC	UL/CUL TÜV	UL/CUL TÜV CQC
File No.	E133481 CQC09002035070	E133481 R50265409	E133481 R50316277 CQC09002033393
Cross Reference	OMRON: G5V-1 PANASONIC: HY FUJITSU: SY NEC: TY TE: V23111	OMRON: G2E FUJITSU: FBR211SC/MZ FBR211SE/MZ AXICOM: V23101 OEG: OUA/OUAZ	OMRON: G5V-2 PANASONIC: DS2Y FUJITSU: FBR244/FTR-C2/R NEC: MR62 AXICOM: V23105/D2N
Page	38	41	44

Note: Specification and dimensions in this catalog are subject to change without notice.

SIGNAL RELAY SELECTION CHART

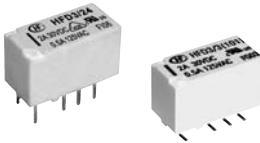
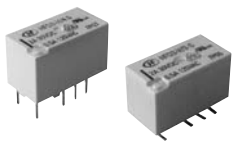
Type	HFD2	HFD3	HFD3-V
Appearance			
Dimensions(L x W x H) mm	20.2 x 10.2 x 10.6	15.0 x 7.5 x 9.0	15.0 x 7.5 x 9.4
Features	<ul style="list-style-type: none"> High sensitive: 150mW High switching capacity: 90W/125VA Epoxy plastic sealed for automatic wave soldering and cleaning Matching standard 16 pin IC socket Bifurcated contacts Single side stable and latching types available 	<ul style="list-style-type: none"> Meets EN60950/EN41003 Surge voltage up to 2500VAC, meets FCC Part 68 and Telecordia 2.5kV dielectric strength (between coil and contacts) Bifurcated contacts Single side stable and latching types available 	<ul style="list-style-type: none"> 3kV dielectric strength (between coil and contacts) Surge withstand voltage up to 6000VAC, meets FCC Part 68 and Telecordia Meets EN60950 / EN41003 Bifurcated contacts Single side stable and latching types available

Contact Ratings

Contact Form	2C	2C	2C
Contact Material	Ag+Au plated, AgPd+Au plated	AgNi + Au plated	AgNi+Au plated, AgPd+Au plated
Max. Switching Current (Res. load)	20 A		
	15 A		
	10 A		
	5 A		
	3 A	3A	4A
2 A			
1 A			
Max. Switching Voltage	250VAC / 220VDC	277VAC / 220VDC	277VAC / 220VDC
Max. Switching Power	125VA / 90W	62.5VA / 60W	62.5VA / 60W
Rated Load (Resistive load)	1A 125VAC 2A 30VDC 3A 30VDC	0.5A 125VAC 2A 30VDC	0.5A 125VAC 2A 30VDC

Coil Ratings

Rated Voltage	3VDC to 48VDC	1.5VDC to 48VDC	1.5VDC to 24VDC
Nominal Operating Power	0.075W, 0.1W, 0.15W, 0.2W	0.05W 0.1W, 0.14W, 0.2W	0.14W, 0.2W

Specifications

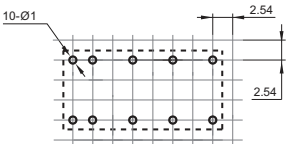
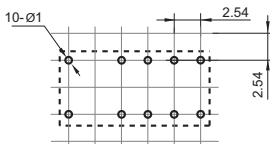
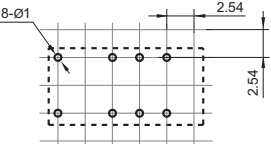

Insulation Resistance	1000MΩ	1000MΩ	1000MΩ
Dielectric Strength (Between coil and contacts)	1500VAC (1 coil)	2000VAC	3000VAC
Ambient Temperature	-40°C to 85°C	-40°C to 85°C	-40°C to 85°C
Operate / Release Time max.	4.5ms / 3.5ms	4ms / 4ms	6ms / 6ms
Mechanical Endurance min.	1 x 10 ⁸ OPS	1 x 10 ⁸ OPS	1 x 10 ⁷ OPS
Electrical Endurance min.	1 x 10 ⁵ OPS (at 1A 125VAC)	1 x 10 ⁵ OPS (at 0.5A 125VAC)	1 x 10 ⁵ OPS (at 0.5A 125VAC)

Layout (Bottom view)			
----------------------	---	--	---

Terminal Type	PCB (DIP)	PCB (DIP, SMT)	PCB (DIP, SMT)
Approved Standards	UL/CUL CQC	UL/CUL VDE	UL/CUL VDE
File No.	E133481 CQC13002095175(Latching) CQC13002095174(Single side stable)	E133481 40018867 CQC14002107409	E133481 40018867 CQC14002107409
Cross Reference	OMRON: G6A PANASONIC: DS2Y FUJITSU: RA NEC: MR82 TE: V23042 / AXICOM: MT2	OMRON: G6S PANASONIC: TX FUJITSU: NA/BA NEC: EC2/ED2 AXICOM: P2/V23079	PANASONIC: TXD2 FUJITSU: FTR-C1
Page	47	51	57

Note: Specification and dimensions in this catalog are subject to change without notice.

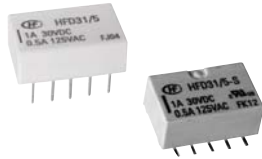
SIGNAL RELAY SELECTION CHART

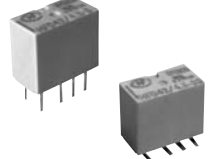
Type	HFD31	HFD4	HFD42
Appearance			
Dimensions(L x W x H) mm	14.0 x 9.0 x 5.0	10.0 x 6.5 x 5.4	10.6 x 5.7 x 9
Features	<ul style="list-style-type: none"> Surge voltage up to 1500VAC, meets FCC Part 68 and Telecordia High contact capacity: 2A 30VDC Single side stable and latching types available 	<ul style="list-style-type: none"> Offers excellent board space savings Surge withstand voltage up to 2500V, meets FCC Part 68 and Telecordia Meets EN60950/EN41003 SMT and DIP types available Single side stable and latching type available 	<ul style="list-style-type: none"> Surge withstand voltage up to 2500V, meets FCC Part 68 and Telecordia Meets EN60950/EN41003 SMT and DIP types available High contact capacity 2A 30VDC Single side stable and latching type available

Contact Ratings

Contact Form	2C	2C	2C	
Contact Material	AgNi+Au plated, AgPd+Au plated	AgNi+Au plated, AgPd+Au plated	AgNi+Au plated, AgPd+Au plated	
Max. Switching Current (Res. load)	20 A			
	15 A			
	10 A			
	5 A			
	3 A			
	2 A	2A	2A	2A
	1 A			
Max. Switching Voltage	125VAC / 110VDC	250VAC / 220VDC	250VAC / 220VDC	
Max. Switching Power	62.5VA / 60W	62.5VA / 60W	125VA / 120W	
Rated Load (Resistive load)	0.5A 125VAC 1A 30VDC 2A 30VDC	0.5A 125VAC 2A 30VDC	0.5A 125VAC 1A 30VDC 1A 125VAC 2A 30VDC	

Coil Ratings

Rated Voltage	1.5VDC to 24VDC	1.5VDC to 24VDC	1.5VDC to 24VDC
Nominal Operating Power	0.1W, 0.14W, 0.2W	0.1W, 0.14W, 0.2W	0.1W, 0.12W, 0.14W, 0.23W

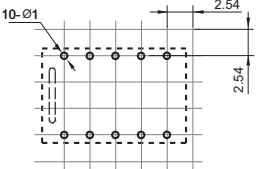
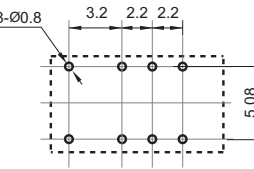
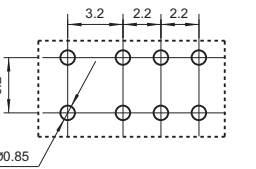

Specifications

Insulation Resistance	1000MΩ	1000MΩ	1000MΩ
Dielectric Strength (Between coil and contacts)	1000VAC	1600VAC	1500VAC
Ambient Temperature	-40°C to 70°C	-40°C to 85°C	-40°C to 85°C
Operate / Release Time max.	3ms / 3ms	3ms / 3ms	3ms / 3ms
Mechanical Endurance min.	1 x 10 ⁸ ops	1 x 10 ⁸ ops	1 x 10 ⁸ ops
Electrical Endurance min.	1 x 10 ⁵ ops (at 0.5A 125VAC)	1 x 10 ⁵ ops (at 0.5A 125VAC)	1 x 10 ⁵ ops

Layout (Bottom view)			
Terminal Type	PCB (DIP, SMT)	PCB (DIP, SMT)	PCB (DIP, SMT)
Approved Standards	UL/CUL	UL/CUL	UL/CUL TÜV
File No.	E133481	E133481	E133481 R50317623
Cross Reference	OMRON: G6H PANASONIC: TQ FUJITSU: A NEC: EA2 AXICOM: FP2	OMRON: G6K PANASONIC: AGQ AXICOM: IM FUJITSU: FTR-B3 NEC: UC2/UD2	OMRON: G6J PANASONIC: AGN AXICOM: IM FUJITSU: FTR-B4 NEC: UA2/UB2
Page	62	67	72

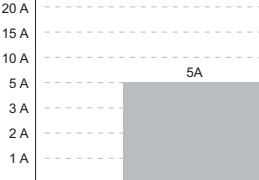
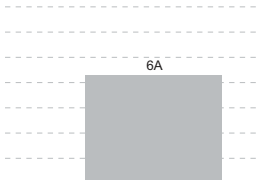
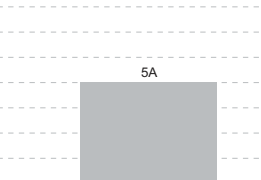
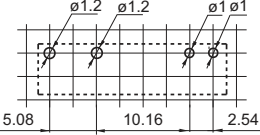
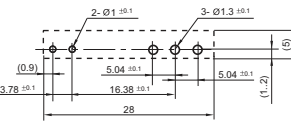
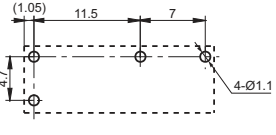

Note: Specification and dimensions in this catalog are subject to change without notice.

POWER RELAY SELECTION CHART

Type	HF49FD	HF41F	HF46F
Appearance			
Dimensions(L x W x H) mm	20.0 x 5.0 x 12.5	28.0 x 5.0 x 15.0	20.5 x 7.0 x 15.3
Features	<ul style="list-style-type: none"> • 5A switching capability • 3kV dielectric strength (between coil and contacts) • Surge voltage up to 4kV (between coil and contacts) • Slim size (width 5mm, height 12.5mm) • High sensitive: 120mW 	<ul style="list-style-type: none"> • Slim size (width 5mm) • 4kV dielectric strength (between coil and contacts) • Surge voltage up to 6kV (between coil and contacts) • High sensitive: 170mW 	<ul style="list-style-type: none"> • 5A switching capability • 10kV impulse withstand voltage (between coil and contacts) • Meets VDE 0631 reinforce insulation • Highly efficient magnetic circuit for high sensitivity: 200mW • Extremely small footprint utilizing PCB area
Contact Ratings			
Contact Form	1A	1A, 1C	1A
Contact Material	AgSnO ₂ , AgNi	AgSnO ₂ , AgNi	AgSnO ₂ , AgNi
Max. Switching Current (Res. load)			
Max. Switching Voltage	250VAC / 30VDC	400VAC / 125VDC	277VAC / 30VDC
Max. Switching Power	1250VA / 150W	1500VA / 180W	1385VA / 150W
Rated Load (Resistive load)	5A 250VAC 5A 30VDC	6A 250VAC 6A 30VDC	3A 250VAC/30VDC 5A 250VAC/30VDC
Coil Ratings			
Rated Voltage	5VDC to 24VDC	5VDC to 60VDC	3VDC to 24VDC
Nominal Operating Power	0.12W to 0.18W	0.17W (48VDC to 60VDC:0.21W)	0.2W
Specifications			
Insulation Resistance	1000MΩ	1000MΩ	1000MΩ
Dielectric Strength (Between coil and contacts)	3000VAC	4000VAC	4000VAC
Ambient Temperature	-40°C to 85°C	-40°C to 85°C	-40°C to 85°C
Operate / Release Time max.	10ms / 5ms	8ms / 4ms	10ms / 10ms
Mechanical Endurance min.	2 x 10 ⁷ ops	1 x 10 ⁷ ops	5 x 10 ⁶ ops
Electrical Endurance min.	1 x 10 ⁵ ops (at 3A 250VAC/30VDC)	1A: 6 x 10 ⁴ ops (at 85°C) 1C: NO: 3 x 10 ⁴ ops (at 85°C) NC: 1 x 10 ⁴ ops (at 85°C)	1.2 x 10 ⁵ ops (at 3A 250VAC/30VDC)
Layout (Bottom view)			
Terminal Type	PCB	PCB	PCB
Approved Standards	UL/CUL TÜV CQC	UL/CUL VDE CQC	UL/CUL VDE CQC
File No.	E133481 R50149334 CQC10002049162	E133481 40020043 CQC09002035072	E134517 40025215 CQC08001024932
Cross Reference	OMRON: G6DS PANASONIC: PA FUJITSU: RB/NY SCHRACK: PCN	PANASONIC: PE FUJITSU: FTR-LY SCHRACK: V23092/SNR FINDER: 34.51	OMRON: G5NB/G5T PANASONIC: LD FUJITSU: FTR-F3
Page	78	81	85

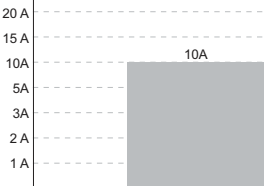
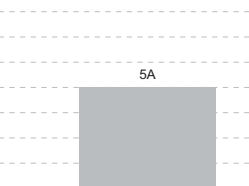
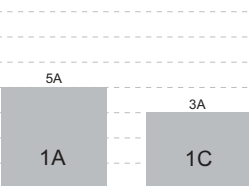
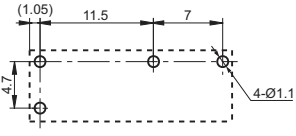
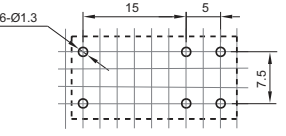
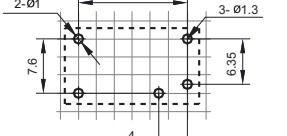

Note: Specification and dimensions in this catalog are subject to change without notice.

POWER RELAY SELECTION CHART

Type	HF46F-G	HF42F	HF32FA
Appearance			
Dimensions(L x W x H) mm	20.5 x 7.0 x 15.3	24.4 x 12.8 x 24.8	17.6 x 10.1 x 12.3
Features	<ul style="list-style-type: none"> • 10A switching capability • 10kV impulse withstand voltage (between coil and contacts) • Meets VDE 0631 reinforce insulation • Highly efficient magnetic circuit for high sensitivity: 200mW • Extremely small footprint utilizing PCB area 	<ul style="list-style-type: none"> • 5A switching capability • TV-3 125VAC approved by UL standard • 2 Form A slim configuration 	<ul style="list-style-type: none"> • 5A switching capability • Creepage/clearance distance>8mm • 5kV dielectric strength (between coil and contacts) • 1 Form A meets VDE 0700/0631 • 1 Form C meets VDE 0631
Contact Ratings			
Contact Form	1A	2A	1A, 1C
Contact Material	AgSnO ₂ , AgNi	AgSnO ₂ , AgCdO	AgNi
Max. Switching Current (Res. load)			
Max. Switching Voltage	277VAC / 30VDC	250VAC / 30VDC	250VAC / 30VDC
Max. Switching Power	2770VA / 300W	1250VA / 150W	1250VA / 150W
Rated Load (Resistive load)	7A 250VAC/30VDC 10A 250VAC/30VDC	5A 250VAC / 30VDC	1A: 5A 250VAC/30VDC 1C: 3A 250VAC/30VDC
Coil Ratings			
Rated Voltage	3VDC to 24VDC	5VDC to 48VDC	3VDC to 48VDC
Nominal Operating Power	0.2W	0.53W	0.2W, 0.45W
Specifications			
Insulation Resistance	1000MΩ	1000MΩ	1000MΩ
Dielectric Strength (Between coil and contacts)	4000VAC	4000VAC	5000VAC
Ambient Temperature	-40°C to 105°C (AgNi contacts) -40°C to 85°C (AgSnO ₂ contacts)	-40°C to 70°C	-40°C to 85°C
Operate / Release Time max.	10ms / 10ms	15ms / 10ms	8ms / 4ms
Mechanical Endurance min.	5 x 10 ⁶ OPS	1 x 10 ⁷ OPS	1 x 10 ⁶ OPS
Electrical Endurance min.	6 x 10 ⁴ OPS	5 x 10 ⁴ OPS (at 5A 250VAC)	1 x 10 ⁵ OPS
Layout (Bottom view)			
Terminal Type	PCB	PCB	PCB
Approved Standards	UL/CUL VDE CQC	UL/CUL TÜV CQC	UL/CUL VDE CQC
File No.	E134517 40025215 CQC08001024932	E133481 R50278397 CQC09002034521	E134517 40006182 CQC09002028689
Cross Reference	OMRON: G5NB/G5T PANASONIC: LD FUJITSU: FTR-F3	OMRON: G5PA-2 PANASONIC: LA FUJITSU: FTR-F4 NEC: CN OEG: OSA/PCI	FUJITSU: JV OEG: OJ/OJE P&B: T77
Page	88	91	94

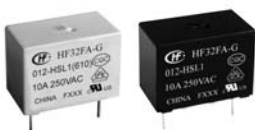

Note: Specification and dimensions in this catalog are subject to change without notice.

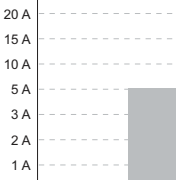
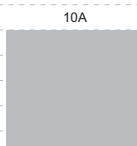
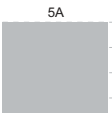
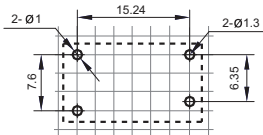
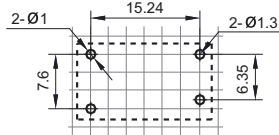
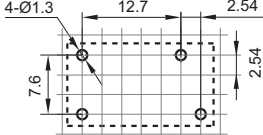
POWER RELAY SELECTION CHART

Type	HF32FA-T	HF32FA-G	HF32FV
Appearance			
Dimensions(L x W x H) mm	17.6 x 10.1 x 12.3	17.6 x 10.1 x 12.3	18.4 x 10.2 x 15.3
Features	<ul style="list-style-type: none"> High temperature: 105°C 5A switching capability Creepage/clearance distance > 8mm 5kV dielectric strength (between coil and contacts) Meets VDE 0700/0631 reinforce insulation 	<ul style="list-style-type: none"> 10A switching capability Creepage/clearance distance > 8mm 5kV dielectric strength (between coil and contacts) Meets VDE 0700/0631 reinforce insulation 	<ul style="list-style-type: none"> 5A switching capability Creepage distance: 6.5mm (between coil & contacts) Dielectric strength 4kV Standard PCB layout Plastic sealed and flux proofed types available UL insulation system: Class F
Contact Ratings			
Contact Form	1A	1A	1A
Contact Material	AgNi	AgSnO ₂	AgSnO ₂ , AgCdO, AgNi
Max. Switching Current (Res. load)			
Max. Switching Voltage	250VAC / 30VDC	250VAC	277VAC / 30VDC
Max. Switching Power	1250VA / 150W	2500VA	1250VA / 150W
Rated Load (Resistive load)	5A 250VAC 5A 30VDC	10A 250VAC	5A 250VAC / 30VDC L type: 3A 250VAC / 30VDC
Coil Ratings			
Rated Voltage	3VDC to 24VDC	3VDC to 48VDC	3VDC to 48VDC
Nominal Operating Power	0.2W	0.23W, 0.45W	0.2W, 0.45W
Specifications			
Insulation Resistance	1000MΩ	1000MΩ	1000MΩ
Dielectric Strength (Between coil and contacts)	5000VAC	5000VAC	4000VAC
Ambient Temperature	-40°C to 105°C	-40°C to 85°C	-40°C to 85°C
Operate / Release Time max.	8ms / 4ms	8ms / 4ms	8ms / 5ms
Mechanical Endurance min.	1 x 10 ⁶ OPS	1 x 10 ⁶ OPS	1 x 10 ⁷ OPS
Electrical Endurance min.	1 x 10 ⁵ OPS (at 5A 250VAC)	1 x 10 ⁴ OPS	1 x 10 ⁵ OPS
Layout (Bottom view)			
Terminal Type	PCB	PCB	PCB
Approved Standards	UL/CUL VDE CQC	UL/CUL VDE CQC	UL/CUL VDE CQC
File No.	E134517 40006182 CQC09002028689	E134517 40006182 CQC09002028689	E134517 40012204 CQC14002120720
Cross Reference	FUJITSU: JV OEG: OJ/OJE P&B: T77	FUJITSU: JV OEG: OJ/OJE P&B: T77	FUJITSU: JV OEG: OJ/OJE P&B: T77
Page	97	100	103

Note: Specification and dimensions in this catalog are subject to change without notice.

POWER RELAY SELECTION CHART

Type	HF32FV-G	HF32F	HF32F-G
Appearance			
Dimensions(L x W x H) mm	18.4 x 10.2 x 15.3	18.4 x 10.2 x 15.3	18.4 x 10.2 x 15.3
Features	<ul style="list-style-type: none"> • 10A switching capability • Creepage distance: 6.5mm (between coil & contacts) • Dielectric strength 4kV • Standard PCB layout • Plastic sealed and flux proofed types available • UL insulation system: Class F 	<ul style="list-style-type: none"> • 10A switching capability • Subminiature standard PCB layout • Plastic sealed and flux proofed types available 	<ul style="list-style-type: none"> • 10A switching capability • 1 Form A configurations • Subminiature standard PCB layout • Plastic sealed and flux proofed types available

Contact Ratings

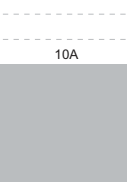
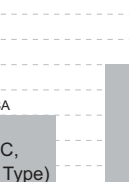
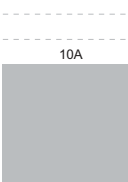
Contact Form	1A	1A, 1C	1A
Contact Material	AgSnO ₂ , AgCdO, AgNi	AgNi, AgCdO	AgSnO ₂ , AgNi, AgCdO
Max. Switching Current (Res. load)			
Max. Switching Voltage	277VAC / 30VDC	250VAC / 30VDC	250VAC / 30VDC
Max. Switching Power	2500VA / 300W	1250VA / 150W	2500VA / 300W
Rated Load (Resistive load)	10A 250VAC / 30VDC 8A 250VAC / 30VDC (Sensitive Type)	1A: 10A 125VAC 5A 250VAC/30VDC L Type: 3A 250VAC/30VDC 1C: 3A 250VAC/30VDC	10A 250VAC 10A 30VDC

Coil Ratings

Rated Voltage	3VDC to 48VDC	3VDC to 48VDC	3VDC to 48VDC
Nominal Operating Power	0.2W, 0.45W	0.2W, 0.45W	0.45W

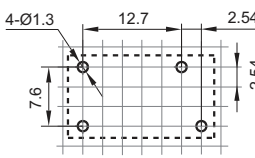
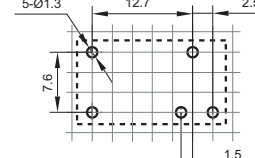
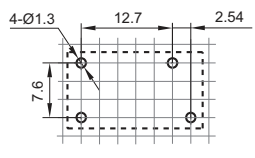

Specifications

Insulation Resistance	1000MΩ	1000MΩ	1000MΩ
Dielectric Strength (Between coil and contacts)	4000VAC	2500VAC	2500VAC
Ambient Temperature	-40°C to 85°C	-40°C to 70°C	-40°C to 85°C
Operate / Release Time max.	8ms / 5ms	8ms / 5ms	8ms / 5ms
Mechanical Endurance min.	1 x 10 ⁷ OPS	5 x 10 ⁶ OPS	1 x 10 ⁶ OPS
Electrical Endurance min.	1 x 10 ⁵ OPS	1 x 10 ⁵ OPS	1 x 10 ⁵ OPS

Layout (Bottom view)			
Terminal Type	PCB	PCB	PCB
Approved Standards	UL/CUL VDE CQC	UL/CUL VDE CQC	UL/CUL VDE CQC
File No.	E134517 40012204 CQC14002120720	E134517 40012204 CQC12002076528	E134517 40012204 CQC12002076528
Cross Reference	FUJITSU: JV OEG: OJ/OJE P&B: T77	FUJITSU: JV OEG: OJ/OJE P&B: T77	FUJITSU: JV OEG: OJ/OJE P&B: T77
Page	106	109	112

Note: Specification and dimensions in this catalog are subject to change without notice.

POWER RELAY SELECTION CHART

Type	HF33F	HF36F	HF36FD
Appearance			
Dimensions(L x W x H) mm	20.5 x 10.2 x 15.3	23.8 x 9.5 x 24.5	23.8 x 9.5 x 24.5
Features	<ul style="list-style-type: none"> • 10A switching capability • Creepage distance:8mm (both for 1 CO and NO) • Clearance distance: NO type 4.5mm; NC type 4mm • Plastic sealed and flux proofed types available 	<ul style="list-style-type: none"> • 10A switching capability • TV-5 125VAC approved by UL standard (only for 1 Form A) • 1 Form A and 1 Form C configurations • Plastic sealed and flux proofed types available 	<ul style="list-style-type: none"> • 10A switching capability • TV-8 125VAC approved by UL standard(118A inrush current) • Ideal for device power reduction

Contact Ratings

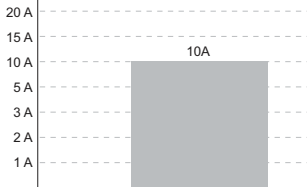
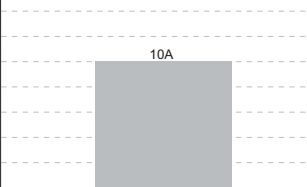
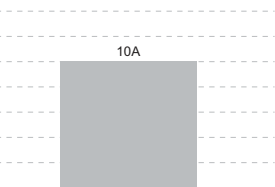
Contact Form	1A, 1C	1A, 1C	1A
Contact Material	AgSnO ₂ , AgNi, AgCdO	AgSnO ₂ , AgCdO	AgSnO ₂
Max. Switching Current (Res. load)			
Max. Switching Voltage	277VAC / 30VDC	250VAC / 30VDC	250VAC / 30VDC
Max. Switching Power	1250VA / 150W	2500VA / 300W	2500VA / 150W
Rated Load (Resistive load)	NO: 10A 125VAC 5A 250VAC/30VDC NC: 3A 250VAC/30VDC	10A 250VAC/30VDC TV-5 125VAC	10A 250VAC 5A 250VAC/30VDC TV-8 125VAC

Coil Ratings

Rated Voltage	3VDC to 48VDC	5VDC to 48VDC	5VDC to 48VDC
Nominal Operating Power	0.2W, 0.45W	0.25W, 0.53W	0.25W, 0.53W

Specifications



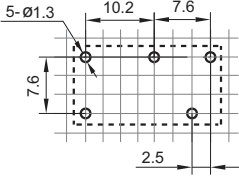
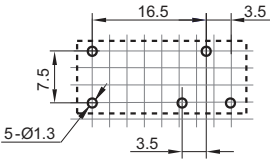
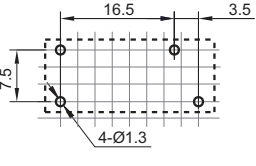

Insulation Resistance	1000MΩ	1000MΩ	1000MΩ
Dielectric Strength (Between coil and contacts)	4000VAC	4000VAC (NO), 3000VAC (NC)	4000VAC
Ambient Temperature	-40°C to 70°C	-40°C to 70°C	-40°C to 70°C
Operate / Release Time max.	8ms / 5ms	15ms / 5ms	15ms / 5ms
Mechanical Endurance min.	5 x 10 ⁶ OPS	1 x 10 ⁷ OPS	1 x 10 ⁶ OPS
Electrical Endurance min.	1 x 10 ⁵ OPS	5 x 10 ⁴ OPS (at 10A 250VAC)	5 x 10 ⁴ OPS (at 10A 250VAC)

Layout (Bottom view)			
----------------------	---	--	---

Terminal Type	PCB	PCB	PCB
Approved Standards	UL/CUL VDE CQC	UL/CUL TÜV CQC	UL/CUL TÜV CQC
File No.	E134517 125661 CQC12002076530	E134517 R50356442 CQC16002159838	E134517 R50356444 CQC16002159846
Cross Reference	OMRON: G5SB/G5Q PANASONIC: JQ/PQ FUJITSU: JY SCHRACK: RE/REL OEG: PCH	OMRON: G5PA-1 PANASONIC: LK FUJITSU: FTR-H2/F2 NEC: CK OEG: SDT	OMRON: G5PA-1 PANASONIC: LK NEC: CK OEG: SDT
Page	114	117	120

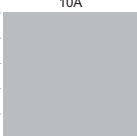
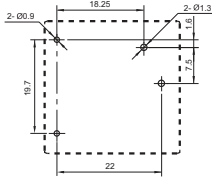
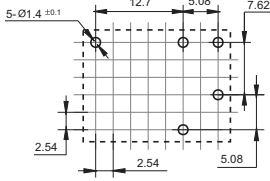
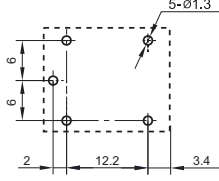

Note: Specification and dimensions in this catalog are subject to change without notice.

POWER RELAY SELECTION CHART

Type	HF162F	HF8	HF3FA
Appearance			
Dimensions(L x W x H) mm	26.3 x 26.1 x 10.0	21.3 x 16.2 x 14.4	19.0 x 15.2 x 15.5
Features	<ul style="list-style-type: none"> • High inrush current: TV-8 125VAC (118A inrush current) • Low height, only 9.3mm (excluding buttons) • High sensitivity: 250mW, • Silent type available 	<ul style="list-style-type: none"> • Sub miniature, high sensitive, Standard PCB layout • 1 Form A and 1 Form C configurations • Plastic sealed type for automatic wave soldering 	<ul style="list-style-type: none"> • 15A switching capability • 2.5kV dielectric strength (between coil and contacts) • Flammability class according to UL94, V-0 • CTI 250
Contact Ratings			
Contact Form	1A	1A, 1C	1A, 1C
Contact Material	AgSnO ₂	AgNi	AgSnO ₂
Max. Switching Current (Res. load)			
Max. Switching Voltage	277VAC	300VAC / 30VDC	277VAC / 30VDC
Max. Switching Power	2216VA	1800VA / 300W	2770VA / 280W
Rated Load (Resistive load)	10A 125VAC 8A/5A 277VAC TV-8 125VAC 3A/100A 250VAC (Capacitive) (Standard type)	HF8: 6A 300VAC/28VDC HF8A: 6A 277VAC/30VDC	1A: 10A 250VAC 1C: NO: 10A 250VAC NO/NC: 5A/5A 250VAC
Coil Ratings			
Rated Voltage	3VDC to 24VDC	3VDC to 48VDC	3VDC to 48VDC
Nominal Operating Power	0.25W	0.33W, 0.45W, 0.6W	0.36W
Specifications			
Insulation Resistance	1000MΩ	100MΩ	100MΩ
Dielectric Strength (Between coil and contacts)	4000VAC	2000VAC	2500VAC
Ambient Temperature	-40°C to 70°C	-55°C to 90°C	-40°C to 85°C
Operate / Release Time max.	15ms / 5ms	6ms / 3ms	10ms / 5ms
Mechanical Endurance min.	1 x 10 ⁶ OPS	1 x 10 ⁷ OPS	1 x 10 ⁷ OPS
Electrical Endurance min.	5 x 10 ⁴ OPS (at 10A 125VAC)	1 x 10 ⁵ OPS	1 x 10 ⁵ OPS (NO, at 8A 250VAC)
Layout (Bottom view)			
Terminal Type	PCB	PCB	PCB
Approved Standards	UL/CUL VDE CQC	UL/CUL VDE	UL/CUL VDE CQC
File No.	E133481 40032669 CQC10002050942	E134517 40025189	E134517 40023708 CQC12002076529
Cross Reference	OMRON: G5PF PANASONIC: LK-F	FUJITSU: LZ P&B: T73 OEG: OUDH	OMRON: G5LA PANASONIC: JS SCHRACK: T7S SONG CHUAN: 899
Page	122	124	127

Note: Specification and dimensions in this catalog are subject to change without notice.

POWER RELAY SELECTION CHART

Type	HF3FD	HF3FF	HF3F-L
Appearance			
Dimensions(L x W x H) mm	19.0 x 15.2 x 15.5	19.0 x 15.2 x 15.5	19.0 x 15.2 x 15.5
Features	<ul style="list-style-type: none"> • 15A switching capability • Subminiature, standard PCB layout • Flammability class according to UL94, V-0 • Plastic sealed and flux proofed types available 	<ul style="list-style-type: none"> • 15A switching capability • Subminiature, standard PCB layout • 1 Form A and 1 Form C configurations • Plastic sealed and flux proofed types available 	<ul style="list-style-type: none"> • Subminiature high power latching relay • Low coil power • 15A switching capability • 1 Form A and 1 Form C configurations • Subminiature, standard PCB layout • Plastic sealed and flux proofed types available

Contact Ratings

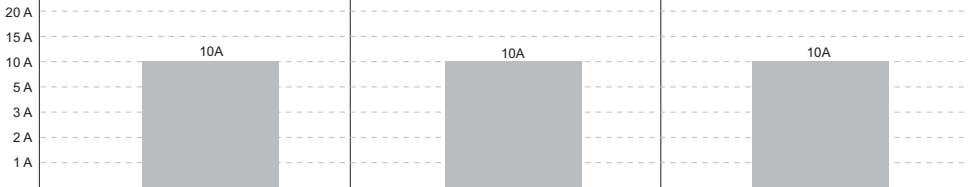
Contact Form	1A, 1C	1A, 1C	1A, 1C
Contact Material	AgSnO ₂	AgSnO ₂ , AgCdO	AgSnO ₂
Max. Switching Current (Res. load)			
Max. Switching Voltage	277VAC / 30VDC	277VAC / 28VDC	277VAC / 30VDC
Max. Switching Power	2770VA / 300W	2770VA / 280W	2770VA / 300W
Rated Load (Resistive load)	1A: 10A 250VAC 1C: NO: 10A 250VAC NO/NC: 5A/5A 250VAC	10A 277VAC 10A 28VDC	10A 277VAC

Coil Ratings

Rated Voltage	3VDC to 48VDC	5VDC to 48VDC	5VDC to 48VDC
Nominal Operating Power	0.36W	0.36W (48VDC: 0.51W)	0.4W, 0.8W

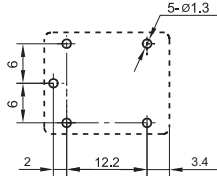
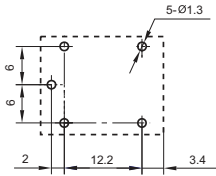
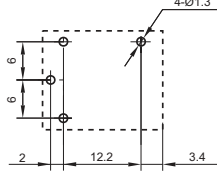

Specifications

Insulation Resistance	100MΩ	100MΩ	100MΩ
Dielectric Strength (Between coil and contacts)	2000VAC	1500VAC	2000VAC
Ambient Temperature	-40°C to 105°C	-40°C to 70°C	-40°C to 85°C
Operate / Release Time max.	10ms / 5ms	10ms / 5ms	8ms / 5ms
Mechanical Endurance min.	1 x 10 ⁷ OPS	1 x 10 ⁷ OPS	1 x 10 ⁷ OPS
Electrical Endurance min.	5 x 10 ⁴ OPS (NO, at 10A 250VAC)	5 x 10 ⁴ OPS (NO, at 10A 250VAC, 70°C)	1 x 10 ⁴ OPS

Layout (Bottom view)			
Terminal Type	PCB	PCB	PCB
Approved Standards	UL/CUL VDE CQC	UL/CUL VDE TÜV CQC	UL/CUL VDE CQC
File No.	E134517 40014057 CQC14002114760	E134517 40025218 R50148356 CQC13002098175	E134517 40040757 CQC15002121475
Cross Reference	OMRON: G5LB(White) PANASONIC: JS SCHRACK: T7S SONG CHUAN: 899	OMRON: G5LB(Black) PANASONIC: JS P&B: T72 OEG: PCE/ORWH FINDER: 36.11 SONG CHUAN: 833	
Page	130	133	136

Note: Specification and dimensions in this catalog are subject to change without notice.

POWER RELAY SELECTION CHART

Type	HF3FF-M	HF7FF	HF7FD
Appearance			
Dimensions(L x W x H) mm	19.0 x 15.2 x 15.5	22.5 x 16.5 x 16.5	22.0 x 16.0 x 16.4
Features	<ul style="list-style-type: none"> • 15A switching capability • Subminiature, standard PCB layout • Plastic sealed and Flux proofed types available • RoHS & ELV compliant 	<ul style="list-style-type: none"> • 10A switching capability • Low cost, small package • 1 Form A and 1 Form C configurations • Plastic sealed and flux proofed types available 	<ul style="list-style-type: none"> • 12A switching capability • High performance, Low profile • 2kV dielectric strength (between coil and contacts) • UL94, V-0, CTI250 flammability class

Contact Ratings

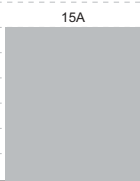
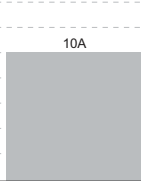
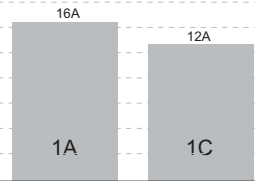
Contact Form	1A, 1C	1A, 1C	1A, 1C
Contact Material	AgSnO ₂	AgSnO ₂ , AgCe	AgSnO ₂ , AgCdO
Max. Switching Current (Res. load)			
Max. Switching Voltage	30VDC	250VAC / 30VDC	250VAC / 28VDC
Max. Switching Power		2400VA / 280W	4000VA / 280W, 2500VA / 196W
Rated Load (Resistive load)	1A: 15A 13.5VDC 1C: NO: 15A 13.5VDC NC: 5A 13.5VDC	10A 250VAC/28VDC 5A 250VAC/30VDC	1A: 16A 250VAC (7FD-T) 12A 250VAC, Double pin, 10A 250VAC 1C: 12A 125VAC (NO) NO/NC: 7A 250VAC

Coil Ratings

Rated Voltage	9VDC to 24VDC	3VDC to 48VDC	3VDC to 48VDC
Nominal Operating Power	0.45W, 0.64W, 0.80W	0.36W (48VDC: 0.51W)	0.36W

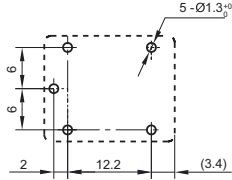
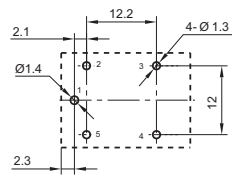
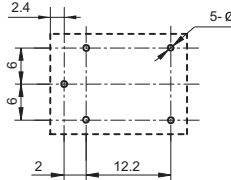

Specifications

Insulation Resistance	100MΩ	100MΩ	100MΩ
Dielectric Strength (Between coil and contacts)	1500VAC	1500VAC	2000VAC
Ambient Temperature	-40°C to 85°C	-40°C to 70°C	-40°C to 85°C
Operate / Release Time max.	10ms / 10ms	10ms / 5ms	10ms / 5ms
Mechanical Endurance min.	1 x 10 ⁷ OPS	1 x 10 ⁷ OPS	1 x 10 ⁷ OPS
Electrical Endurance min.	1 x 10 ⁵ OPS	1 x 10 ⁵ OPS	5 x 10 ⁴ OPS(1A)

Layout (Bottom view)			
Terminal Type	PCB	PCB	PCB
Approved Standards		UL/CUL CQC	UL/CUL VDE CQC
File No.		E134517 CQC09002028260	E134517 40008374 CQC09002037921
Cross Reference	OMRON: G8SN PANASONIC: JSM SCHRACK: T72N	OMRON: G5LC/G5LE PANASONIC: JSM FUJITSU: CS SCHRACK: T7N OEG: PCE	OMRON: G5LE-VD PANASONIC: JSM FUJITSU: FBR160 NEC: KB SCHRACK: T7N-WG
Page	139	142	145

Note: Specification and dimensions in this catalog are subject to change without notice.

POWER RELAY SELECTION CHART

Type	HF21FF	HF152F	HF152FD
Appearance			
Dimensions(L x W x H) mm	20.2 x 16.5 x 20.2	21.0 x 16.0 x 20.6	21.2 x 16.0 x 20.6
Features	<ul style="list-style-type: none"> • 15A switching capability • 1 Form A, 1 Form B and 1 Form C configurations • Standard PCB layout • Plastic sealed and flux proofed available 	<ul style="list-style-type: none"> • 20A switching capacity • Surge voltage up to 6000VAC (between coil and contacts) • 1 Form C and 1 Form A configurations • Plastic sealed and dust protected types available 	<ul style="list-style-type: none"> • 20A switching capability • Ambient temperature meets 105°C • High temperature load: 17A 277VAC at 105°C • 1 Form C & 1 Form A configurations available • Product in accordance to EN 60335-1 available

Contact Ratings

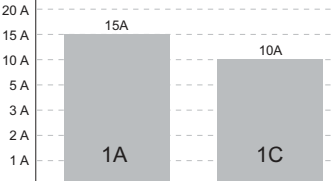
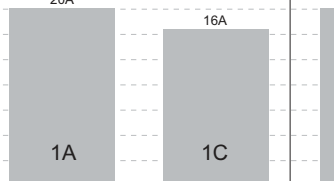
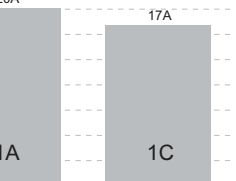
Contact Form	1A, 1B, 1C	1A, 1C	1A, 1C
Contact Material	AgSnO ₂	AgSnO ₂ , AgNi	AgSnO ₂ , AgNi
Max. Switching Current (Res. load)			
Max. Switching Voltage	120VAC	1A: 400VAC / 1C: 400VAC(NO)	400VAC
Max. Switching Power	1800VA	1A: 4700VA / 1C: 4000VA	4700VA
Rated Load (Resistive load)	1A: 15A 120VAC 1C: 10A 120VAC 1B: 15A 120VAC 1800VA(Ballast)	1A: 20A 125VAC / 17A 277VAC 7A 400VAC 1C: 16A 250VAC NO: 7A 400VAC	1A: 7A 400VAC 17A 277VAC 20A 125VAC 1C: NO:17A 277VAC NC:10A 277VAC

Coil Ratings

Rated Voltage	5VDC to 48VDC	3VDC to 48VDC	3VDC to 48VDC
Nominal Operating Power	0.36W (48VDC: 0.53W)	0.36W	0.36W



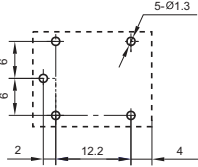
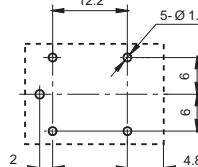
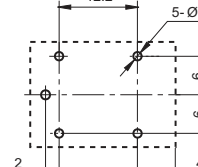

Specifications

Insulation Resistance	1000MΩ	100MΩ	1000MΩ
Dielectric Strength (Between coil and contacts)	1500VAC	2500VAC	2500VAC
Ambient Temperature	-40°C to 70°C	-40°C to 105°C (HF152F-T)	-40°C to 105°C
Operate / Release Time max.	10ms / 5ms	10ms / 5ms	10ms / 5ms
Mechanical Endurance min.	1 x 10 ⁷ OPS	1 x 10 ⁷ OPS	1 x 10 ⁷ OPS
Electrical Endurance min.	1 x 10 ⁵ OPS	1A: 1 x 10 ⁵ OPS / 1C: 5 x 10 ⁴ OPS	1A: 1 x 10 ⁵ OPS / 1C: 5 x 10 ⁴ OPS

Layout (Bottom view)			
Terminal Type	PCB	PCB	PCB
Approved Standards	UL/CUL	UL/CUL VDE CQC	UL/CUL VDE CQC
File No.	E133481	E134517 40017837 CQC09002034520	E134517 40031203 CQC12002083404
Cross Reference	OMRON: G5L SCHRACK: LN/41896 OEG: SRUDH/SRUUH	OMRON: G5LE-VD PANASONIC: JSM	OMRON: G5LE-VD PANASONIC: JSM SCHRACK: LN-H
Page	148	151	154

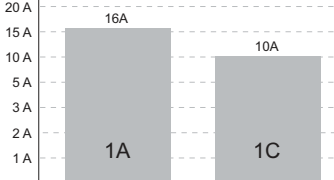
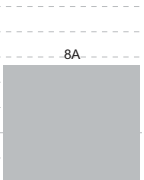

Note: Specification and dimensions in this catalog are subject to change without notice.

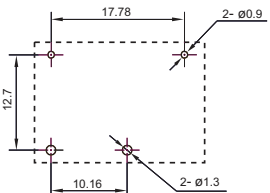
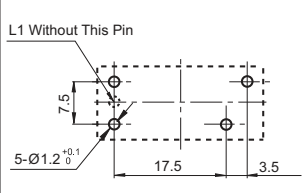
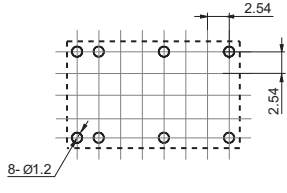
POWER RELAY SELECTION CHART



Type	HF7520	HF163F-L	HFE7
Appearance			
Dimensions(L x W x H) mm	22.0 x 16.0 x 10.5	24.0 x 10.0 x 18.8	20.0 x 15.0 x 10.2
Features	<ul style="list-style-type: none"> • Low height, flat construction • 16A switching capability • High sensitive 200mW • PCB & QC terminals available • Plastic sealed and flux proofed types available (with vent-hole cover) 	<ul style="list-style-type: none"> • Latching relay • High sensitive • Breakdown voltage (between contact and coil): 5,000 V • High switching capacity: 8A 250VAC • Surge breakdown voltage(between contact and coil): 12,000 V • Reflow soldering available 	<ul style="list-style-type: none"> • High switching capacity 1A: 10A 250VAC/8A 30VDC; 2A, 1A + 1B: 8A 250VAC/30VDC • High sensitive • 1 Form A, 2 Form A and 1A + 1B contact arrangement • Single side stable and latching types available
Contact Ratings			
Contact Form	1A 1C	1A	1A, 1B 2A, 2B, 1A+1B
Contact Material	AgSnO ₂ , AgNi, AgCdO		AgSnO ₂ , AgNi
Max. Switching Current (Res. load)			
Max. Switching Voltage	250VAC / 30VDC		277VAC
Max. Switching Power	4000VA/300W 2500VA/1500VA	2500VA/150W	2500VA 2000VA
Rated Load (Resistive load)	1A: 16A 250VAC 10A 250VAC/30VDC TV-5 1C: NO/NC:10A/6A 125/250VAC	8A 250VAC 5A 30VDC	10A 250VAC 10A 30VDC 8A 250VAC 10A 30VDC
Coil Ratings			
Rated Voltage	5VDC to 48VDC	3VAC to 24VAC / 3VDC to 24VDC	3VDC to 24VDC
Nominal Operating Power	0.2W, 0.4W	0.2W, 0.4W	0.2W, 0.28W, 0.3W, 0.42W
Specifications			
Insulation Resistance	1000MΩ	1000MΩ	1000MΩ
Dielectric Strength (Between coil and contacts)	2500VAC	5000VAC	4000VAC
Ambient Temperature	-40°C to 105°C	-40°C to 85°C	-40°C to 70°C
Operate / Release Time max.	15ms / 5ms	15ms / 15ms	10ms / 10ms
Mechanical Endurance min.	1 x 10 ⁷ OPS	1 x 10 ⁶ OPS	5 x 10 ⁷ OPS
Electrical Endurance min.	5 x 10 ⁴ OPS	5 x 10 ⁴ OPS (at 8A 250VAC)	1 x 10 ⁵ OPS(2 Form A: 3 x 10 ⁴ OPS)
Layout (Bottom view)			
Terminal Type	PCB, QC	PCB	PCB
Approved Standards	UL/CUL TÜV CQC	UL/CUL VDE	UL/CUL VDE
File No.	E133481 R50351269 CQC09002034524	E134517 40039460	E134517 40027342
Cross Reference	OMRON: G5CA PANASONIC: JV/JVN NEC: CQ OEG: PCD	PANASONIC: DW	OMRON: G6C PANASONIC: DK
Page	157	161	164

Note: Specification and dimensions in this catalog are subject to change without notice.

POWER RELAY SELECTION CHART

Type	HF118F	HF115F	HF115F-A
Appearance			
Dimensions(L x W x H) mm	28.5 x 10.1 x 12.5	29.0 x 12.7 x 15.7	29.0 x 12.7 x 15.7
Features	<ul style="list-style-type: none"> • 10A switching capability • 5kV dielectric strength (between coil and contacts) • Low height: 12.5 mm • Creepage distance >8mm (VDE0435/0631/0700) • Product in accordance to IEC 60335-1 available 	<ul style="list-style-type: none"> • Low height: 15.7 mm • 16A switching capability • 5kV dielectric strength (between coil and contacts) • Creepage distance: 10mm • Meet VDE0435/0631/0700 • Product in accordance to IEC 60335-1 available 	<ul style="list-style-type: none"> • AC coil voltage type • 16A switching capability • 5kV dielectric strength (between coil and contacts) • Creepage distance: 10mm • Meet VDE0700/0631 • Product in accordance to IEC 60335-1 available

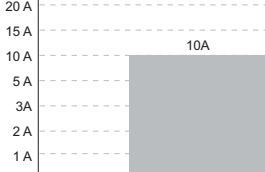
Contact Ratings

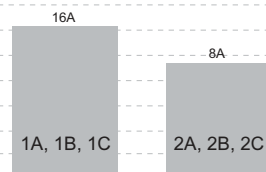
Contact Form	1A, 1B, 1C	1A, 1B, 1C	2A, 2B, 2C	1A, 1B, 1C	2A, 2B, 2C
Contact Material	AgSnO ₂ , AgNi	AgSnO ₂ , AgNi, AgCdO		AgSnO ₂ , AgNi, AgCdO	
Max. Switching Current (Res. load)					
Max. Switching Voltage	440VAC / 125VDC	440VAC / 300VDC		440VAC / 300VDC	
Max. Switching Power	2500VA/300W	3000VA/4000VA	2000VA	3000VA/4000VA	2000VA
Rated Load (Resistive load)	10A 250VAC 10A 30VDC	16A 250VAC 12A 250VAC	8A 250VAC	16A 250VAC 12A 250VAC	8A 250VAC

Coil Ratings

Rated Voltage	5VDC to 60VDC	5VDC to 110VDC	24VAC, 115VAC, 230VAC
Nominal Operating Power	0.22W to 0.29W	0.4W	0.75VA

Specifications

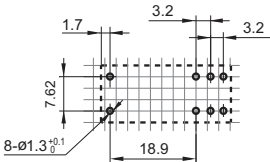
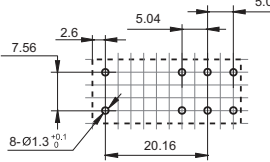
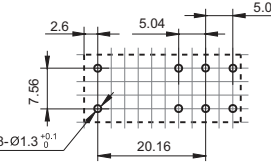

Insulation Resistance	1000MΩ	1000MΩ	1000MΩ
Dielectric Strength (Between coil and contacts)	5000VAC	5000VAC	5000VAC
Ambient Temperature	-40°C to 85°C	-40°C to 85°C	-40°C to 70°C
Operate / Release Time max.	10ms / 5ms	15ms / 8ms	
Mechanical Endurance min.	1 x 10 ⁷ OPS	1 x 10 ⁷ OPS	1 x 10 ⁵ OPS
Electrical Endurance min.	1 x 10 ⁵ OPS (at 8A 250VAC)	1 x 10 ⁵ OPS	5 x 10 ⁴ OPS

Layout (Bottom view)			
----------------------	---	--	---

Terminal Type	PCB	PCB	PCB
Approved Standards	UL/CUL VDE CQC	UL/CUL VDE CQC	UL/CUL VDE
File No.	E134517 40010480 CQC09002035071	E134517 116934 CQC08002028130	E134517 116934
Cross Reference	OMRON: G6RN FUJITSU: JS SCHRACK: RYII	OMRON: G2RL PANASONIC: LZ SCHRACK: RT FUJITSU: FTR-K1 FINDER: 41 SERIES RELPOL: RM84/85	OMRON: G5RL-AC SCHRACK: RT RELPOL: RM84/85
Page	168	171	175

Note: Specification and dimensions in this catalog are subject to change without notice.

POWER RELAY SELECTION CHART

Type	HF115F-T/TH	HF115F-H	HF115F-I
Appearance			
Dimensions(L x W x H) mm	29.0 x 12.7 x 15.7	29.0 x 12.7 x 15.7	29.0 x 12.7 x 15.7
Features	<ul style="list-style-type: none"> • High temperature: 105°C • 5kV dielectric strength (between coil and contacts) • Creepage distance: 10mm • Meet VDE0700/0631 • Product in accordance to IEC 60335-1 available 	<ul style="list-style-type: none"> • High sensitive: 0.25W • 5kV dielectric strength (between coil and contacts) • Creepage distance: 10mm • Meet VDE0700/0631 • Product in accordance to IEC 60335-1 available 	<ul style="list-style-type: none"> • High inrush: TV-5 80A(at 120VAC) • 5kV dielectric strength (between coil and contacts) • Creepage distance: 10mm • Meet VDE0700/0631 • Product in accordance to IEC 60335-1 available

Contact Ratings

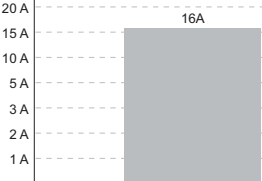
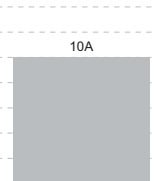
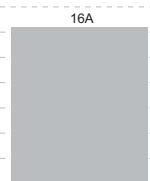
Contact Form	1A, 1C	1A, 1B, 1C	1A,1C
Contact Material	AgSnO ₂ , AgNi, AgCdO	AgSnO ₂ , AgNi, AgCdO	AgSnO ₂
Max. Switching Current (Res. load)			
Max. Switching Voltage	440VAC / 300VDC	440VAC / 300VDC	440VAC / 300VDC
Max. Switching Power	HF115F-T: 4000VA HF115F-TH: 2500VA	2500VA	4000VA
Rated Load (Resistive load)	HF115F-T: 16A 250VAC HF115F-TH: 10A 250VAC	10A 250VAC	1A: 16A 250VAC

Coil Ratings

Rated Voltage	5VDC to 60VDC	5VDC to 60VDC	5VDC to 110VDC
Nominal Operating Power	0.25W, 0.4W	0.25W	0.4W

Specifications

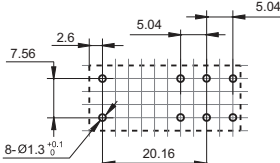
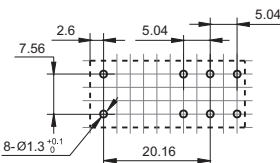
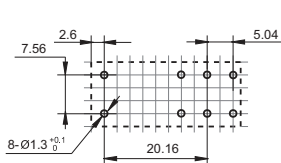

Insulation Resistance	1000MΩ	1000MΩ	1000MΩ
Dielectric Strength (Between coil and contacts)	5000VAC	5000VAC	5000VAC
Ambient Temperature	-40°C to 105°C	-40°C to 85°C	-40°C to 85°C
Operate / Release Time max.	15ms / 8ms	15ms / 8ms	15ms / 8ms
Mechanical Endurance min.	1 x 10 ⁷ OPS	1 x 10 ⁷ OPS	1 x 10 ⁷ OPS
Electrical Endurance min.	1 x 10 ⁵ OPS	1 x 10 ⁵ OPS	7.5 x 10 ⁴ OPS

Layout (Bottom view)			
----------------------	---	--	---

Terminal Type	PCB	PCB	PCB
Approved Standards	UL/CUL VDE CQC	UL/CUL VDE CQC	UL/CUL VDE CQC
File No.	E134517 116934 CQC08002028130	E134517 116934 CQC08002028130	E134517 116934 CQC08002028130
Cross Reference	SCHRACK: RTH105 16A P&B: RT FUJITSU: FTR-K1	SCHRACK: RT1 Sensitive P&B: RT FUJITSU: FTR-K1	SCHRACK: RT1 Inrush P&B: RT FUJITSU: FTR-H1
Page	178	181	184

Note: Specification and dimensions in this catalog are subject to change without notice.

POWER RELAY SELECTION CHART

Type	HF115F-Q	HF115F-S	HF115F-L
Appearance			
Dimensions(L x W x H) mm	Vertical: (41.0 x 12.7 x 15.7) Horizontal: (45.0 x 12.7 x 15.7)	29.0 x 12.7 x 15.7	29.0 x 12.7 x 15.7
Features	<ul style="list-style-type: none"> Ambient temperature up to 125°C 5kV dielectric strength (between coil and contacts) Creepage distance >8mm Meet VDE0700/0631 UL94, V-0 flammability class Product in accordance to IEC 60335-1 available 	<ul style="list-style-type: none"> Special contact struction Incandescent lamp load: 3000W 230VAC Inrush current: 165A/20ms, 800A/200µs 5kV dielectric strength (between coil and contacts) Creepage distance: 10mm Product in accordance to IEC 60335-1 available Plastic sealed and flux proofed types available 	<ul style="list-style-type: none"> Latching relay 20A switching capability 5kV dielectric strength (between coil and contacts) Creepage distance: 11mm-NO/10mm-CO version Meeting VDE 0700, 0631 reinforce insulation Product in accordance to IEC 60335-1 available

Contact Ratings

Contact Form	1A, 1B	1A	1A, 1C	2A, 2C
Contact Material	AgSnO ₂ , AgNi	W+AgSnO ₂	AgSnO ₂	
Max. Switching Current (Res. load)	20A	16A	16A (1C)	8A (2C)
Max. Switching Voltage	440VAC / 300VDC	440VAC	440VAC / 300VDC	
Max. Switching Power	5000VA	4000VA	4000VA	2000VA
Rated Load (Resistive load)	20A 250VAC	Resistive: 16A 250VAC Incandescent Lamp: 3000W 230VAC Inrush current: 165A / 20ms flourescent: 800A/200µs	16A 250VAC	8A 250VAC

Coil Ratings

Rated Voltage	5VDC to 60VDC	5VDC to 110VDC	5VDC to 24VDC
Nominal Operating Power	0.4W	0.4W	0.4W, 0.6W

Specifications

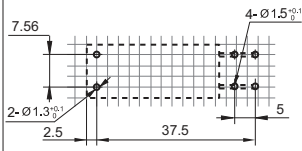
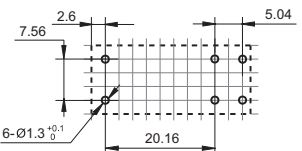
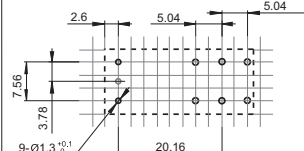

Insulation Resistance	1000MΩ	1000MΩ	1000MΩ
Dielectric Strength (Between coil and contacts)	5000VAC	5000VAC	5000VAC
Ambient Temperature	-40°C to 125°C	-40°C to 85°C	-40°C to 85°C
Operate / Release Time max.	15ms / 8ms	15ms / 8ms	10ms / 10ms
Mechanical Endurance min.	1 x 10 ⁷ OPS	5 x 10 ⁶ OPS	2 x 10 ⁶ OPS
Electrical Endurance min.	3 x 10 ⁴ OPS	1 x 10 ⁴ OPS (at 3000W 230VAC)	5 x 10 ⁴ OPS

Layout (Bottom view)			
Terminal Type	PCB, QC	PCB	PCB
Approved Standards	UL/CUL VDE CQC	UL/CUL VDE CQC	UL/CUL VDE CQC
File No.	E134517 116934 CQC08002028130	E134517 116934 CQC08002028130	E134517 116934 CQC14002104529

Cross Reference	SCHRACK: RF/41063 125°C	TE: RTS3T	PANASONIC: DJ SCHRACK: RT1 bistable FUJITSU: FTR-K1L
Page	187	190	192

Note: Specification and dimensions in this catalog are subject to change without notice.

POWER RELAY SELECTION CHART

Type	HF115F-LS	HF115FP	HF115FK
Appearance			
Dimensions(L x W x H) mm	29.0 x 12.7 x 15.7	29.0 x 13.0 x 25.5	29.0 x 12.7 x 15.7
Features	<ul style="list-style-type: none"> Latching relay Incandescent lamp load: 3500W 277VAC 5kV dielectric strength (between coil and contacts) Creepage distance: 11mm Low height: 15.7 mm Meeting reinforce insulation 	<ul style="list-style-type: none"> Manual test device, Type with mechanical indicator / electrical indicator 5kV dielectric strength (between coil to contacts) Creepage distance: 8mm Meet VDE0700/0631 Sockets available 	<ul style="list-style-type: none"> Low height: 15.7 mm 16A switching capability 5kV dielectric strength (between coil and contacts) Creepage distance: 10mm Meeting reinforce insulation Product in accordance to IEC 60335-1 available

Contact Ratings

Contact Form	1A	1C	2C	1A, 1C	2A, 2C
Contact Material	W + AgSnO ₂	AgNi		AgSnO ₂	
Max. Switching Current (Res. load)	16A	16A	8A	16A	8A
Max. Switching Voltage	440VAC	440VAC		400VAC	
Max. Switching Power	4000VA	4000VA	2000VA	3000VA/4000VA	2000VA
Rated Load (Resistive load)	16A 250VAC	16A 250VAC	8A 250VAC	12A/16A 250VAC	8A 250VAC

Coil Ratings

Rated Voltage	5VDC to 24VDC	24VAC to 230VAC / 12VDC to 110VDC	5VDC to 48VDC
Nominal Operating Power	0.4W, 0.6W	0.75VA, 0.4W	0.4W

Specifications

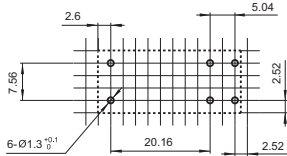
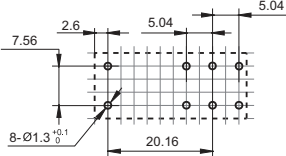
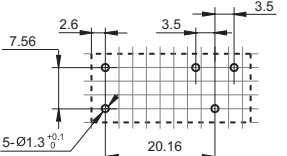

Insulation Resistance	1000MΩ	1000MΩ	1000MΩ
Dielectric Strength (Between coil and contacts)	5000VAC	5000VAC	5000VAC
Ambient Temperature	-40°C to 85°C	-40°C to 70°C	-40°C to 85°C
Operate / Release Time max.	10ms / 10ms	15ms / 15ms (DC)	10ms / 5ms
Mechanical Endurance min.	2 x 10 ⁶ OPS	DC type: 5 x 10 ⁶ OPS AC type: 1 x 10 ⁶ OPS	1 x 10 ⁷ OPS
Electrical Endurance min.	6 x 10 ³ OPS	3 x 10 ⁴ OPS	5 x 10 ⁴ OPS

Layout (Bottom view)			
----------------------	---	--	---

Terminal Type	PCB	PCB	PCB
Approved Standards	UL/CUL VDE CQC	UL/CUL VDE	UL/CUL VDE CQC
File No.	E134517 116934 CQC14002104529	E133481 116934	E134517 116934 CQC13002103948
Cross Reference	TE: RTX/RTS3T	SCHRACK: XT	OMRON: G2RL FUJITSU: FTR-K1 PANASONIC: LZ SCHRACK: RZ
Page	198	201	204

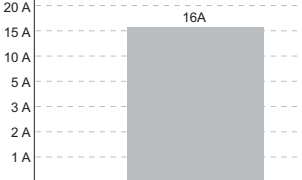
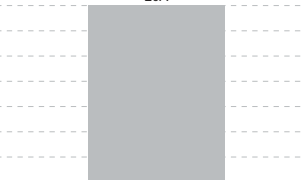
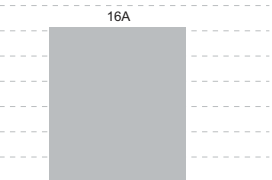
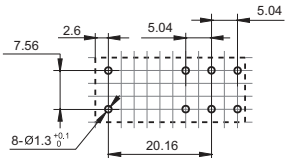
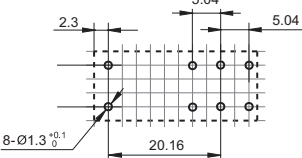
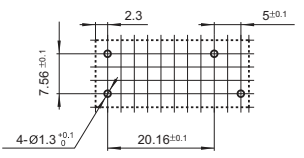

Note: Specification and dimensions in this catalog are subject to change without notice.

POWER RELAY SELECTION CHART

Type	HF115FK-T	HF158F	HF158F-V
Appearance			
Dimensions(L x W x H) mm	29.0 x 12.7 x 15.7	29.0 x 12.7 x 15.7	29.0 x 12.7 x 20.0
Features	<ul style="list-style-type: none"> High temperature: 105°C Low height: 15.7 mm 16A switching capability 5kV dielectric strength (between coil and contacts) Creepage distance: 10mm Meeting reinforce insulation Sockets available 	<ul style="list-style-type: none"> 20A switching capability Low height: 12.5 mm 5kV dielectric strength (between coil and contacts) Creepage distance: 10mm Product in accordance to IEC 60335-1 available 	<ul style="list-style-type: none"> 10A 300VDC high-voltage switching capability 5kV dielectric strength (between coil and contacts) Creepage distance: 10mm Product in accordance to IEC60335-1 available
Contact Ratings			
Contact Form	1A 1C	1A, 1C	1A
Contact Material	AgSnO ₂	AgSnO ₂ , AgNi	AgSnO ₂
Max. Switching Current (Res. load)			
Max. Switching Voltage	400VAC	440VAC	420VDC/300VAC
Max. Switching Power	4000VA	5000VA	3000W/3324VA
Rated Load (Resistive load)	16A 250VAC	16A 250VAC	10A 300VDC 12A 277VAC
Coil Ratings			
Rated Voltage	5VDC to 48VDC	5VDC to 48VDC	5VDC to 24VDC
Nominal Operating Power	0.4W	0.4W	0.4W
Specifications			
Insulation Resistance	1000MΩ	1000MΩ	1000MΩ
Dielectric Strength (Between coil and contacts)	5000VAC	5000VAC	5000VAC
Ambient Temperature	-40°C to 105°C	-40°C to 85°C	-40°C to 85°C
Operate / Release Time max.	10ms / 5ms	15ms / 8ms	10ms / 5ms
Mechanical Endurance min.	1 x 10 ⁷ OPS	2 x 10 ⁷ OPS	2 x 10 ⁶ OPS
Electrical Endurance min.	3 x 10 ⁴ OPS	1 x 10 ⁵ OPS	1 x 10 ⁴ OPS
Layout (Bottom view)			
Terminal Type	PCB	PCB	PCB
Approved Standards	UL/CUL VDE CQC	UL/CUL VDE	UL/CUL VDE CQC
File No.	E134517 116934 CQC13002103948	E134517 40032833 CQC15002129497	E134517 40032833 CQC15002129497
Cross Reference	P&B: RT SCHRACK:RZ FUJITSU: FTR-K1	OMRON: G2RL SCHRACK: RT PANASONIC: LZ RELPOL: RM85 FINDER: 41 SERIES FUJITSU: FTR-K1	
Page	207	210	213

Note: Specification and dimensions in this catalog are subject to change without notice.

POWER RELAY SELECTION CHART

Type	HF141FF	HF14FF	HF14FW
Appearance			
Dimensions(L x W x H) mm	29.0 x 12.6 x 20.6	29.0 x 13.0 x 26.0	29.0 x 13.0 x 26.5
Features	<ul style="list-style-type: none"> • 10A switching capability • 5kV dielectric strength (between coil and contacts) • Plastic sealed and flux proofed types available 	<ul style="list-style-type: none"> • 10A switching capability • 5kV dielectric strength (between coil and contacts) • 1 Form A and 1 Form C configurations • Plastic sealed and flux proofed types available 	<ul style="list-style-type: none"> • 20A switching capability • 4kV dielectric strength (between coil and contacts) • Plastic sealed and flux proofed types available

Contact Ratings

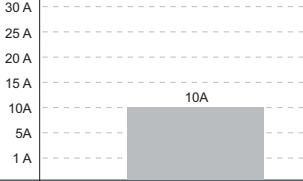
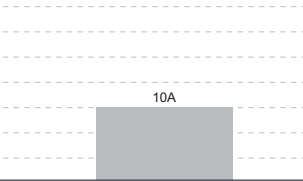
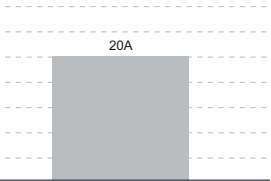
Contact Form	1A, 1B, 1C	1A, 1C	1A, 1B, 1C
Contact Material	AgSnO ₂ , AgCdO	AgSnO ₂ , AgNi, AgCdO	AgSnO ₂ , AgCdO
Max. Switching Current (Resistive load)			
Max. Switching Voltage	250VAC / 30VDC	277VAC / 30VDC	277VAC / 30VDC
Max. Switching Power	2500VA / 300W	2770VA / 300W	5540VA / 480W
Rated Load (Resistive load)	Heavy: 10A 250VAC/30VDC Standard: 8A 250VAC/30VDC 10A 125VAC	10A 277VAC/30VDC TV-5 120VAC	Resistive: 16A 277VAC/24VDC Motor: 1HP 240VAC TV-8 125VAC (NO contact)

Coil Ratings

Rated Voltage	5VDC to 48VDC	3VDC to 60VDC	5VDC to 110VDC
Nominal Operating Power	0.55W, 0.72W	0.53W	0.53W, 0.72W

Specifications

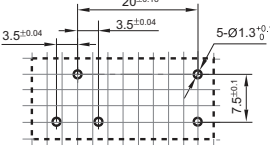
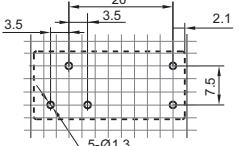
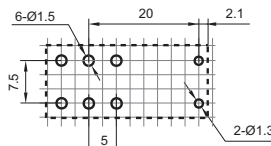

Insulation Resistance	1000MΩ	1000MΩ	1000MΩ
Dielectric Strength (Between coil and contacts)	5000VAC	5000VAC	4000VAC
Ambient Temperature	-40°C to 70°C	-40°C to 70°C	-40°C to 85°C
Operate / Release Time max.	15ms / 5ms	15ms / 5ms	15ms / 5ms
Mechanical Endurance min.	1 x 10 ⁷ OPS	1 x 10 ⁷ OPS	1 x 10 ⁷ OPS
Electrical Endurance min.	1 x 10 ⁵ OPS	1 x 10 ⁵ OPS	1 x 10 ⁵ OPS

Layout (Bottom view)			
----------------------	---	--	---

Terminal Type	PCB	PCB	PCB
Approved Standards	UL/CUL CQC	UL/CUL TÜV CQC	UL/CUL VDE CQC
File No.	E133481 CQC09002034351	E134517 R50140759 CQC10002046169	E134517 40023508 CQC10002046170
Cross Reference	OMRON: G2R PANASONIC: JW FUJITSU: FTR-F1/VSB NEC: TP FINDER: 40.31	OMRON: G2R PANASONIC: JR1/JR1A FUJITSU: VS NEC: CH P&B: RKA/RKS	OMRON: G2R PANASONIC: JR1AF FUJITSU: FBR610 P&B: RKA/RKS
Page	216	219	222

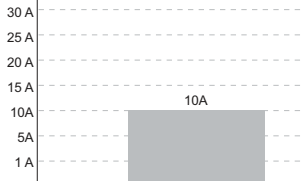
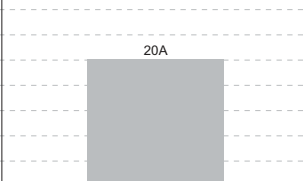
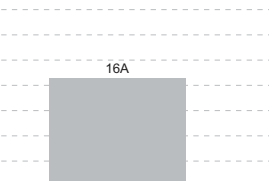
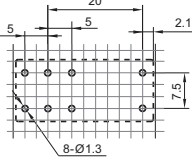
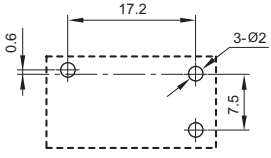
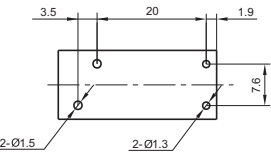

Note: Specification and dimensions in this catalog are subject to change without notice.

POWER RELAY SELECTION CHART



Type	HF140FF	HF25F	HF62F
Appearance			
Dimensions(L x W x H) mm	29.0 x 13.0 x 26.3	22.8 x 12.3 x 24.4	29.0 x 12.6 x 24.4
Features	<ul style="list-style-type: none"> • 10A switching capability • 5kV dielectric strength (between coil and contacts) • 2.0mm contact gap available • Plastic sealed and flux proofed types available 	<ul style="list-style-type: none"> • 20A switching capability • 5kV impulse withstand voltage (between coil and contacts) • small and for microwave oven • PCB & QC layouts • Flux proofed types available 	<ul style="list-style-type: none"> • 20A switching capability • 5kV dielectric strength (between coil and contacts) • 10kV impulse withstand voltage (between coil and contacts) • creepage distance: 8mm
Contact Ratings			
Contact Form	2A, 2C	1A	1A
Contact Material	AgSnO ₂ , AgNi, AgCdO	AgSnO ₂	AgSnO ₂
Max. Switching Current (Resistive load)			
Max. Switching Voltage	250VAC / 30VDC	250VAC / 30VDC	277VAC / 30VDC
Max. Switching Power	2500VA / 240W	5000VA / 480W	4000VA / 480W
Rated Load (Resistive load)	5A 250VAC 10A 250VAC 8A 30VDC	20A 250VAC Motor: 1.5HP 250VAC	16A 250VAC/30VDC
Coil Ratings			
Rated Voltage	3VDC to 110VDC	5VDC to 24VDC	5VDC to 48VDC
Nominal Operating Power	0.53W, 0.8W, 1.4W	0.5W	0.54W
Specifications			
Insulation Resistance	1000MΩ	1000MΩ	1000MΩ
Dielectric Strength (Between coil and contacts)	5000VAC	5000VAC	5000VAC
Ambient Temperature	-40°C to 85°C	-40°C to 85°C	-40°C to 85°C
Operate / Release Time max.	15ms / 5ms	15ms / 5ms	20ms / 10ms
Mechanical Endurance min.	Standard: 1 x 10 ⁷ OPS W Type(1.5mm): 5 x 10 ⁵ OPS W Type(2.0mm): 3 x 10 ⁵ OPS	2 x 10 ⁶ OPS	1 x 10 ⁷ OPS
Electrical Endurance min.	Standard: 1 x 10 ⁵ OPS W Type(1.5mm): 1 x 10 ⁵ OPS W Type(2.0mm): 3 x 10 ⁵ OPS	1 x 10 ⁵ OPS	1 x 10 ⁵ OPS
Layout (Bottom view)			
Terminal Type	PCB	PCB, QC	PCB, QC
Approved Standards	UL/CUL TÜV CQC	UL/CUL VDE TÜV CQC	UL/CUL TÜV CQC
File No.	E134517 R50149131 CQC09002030294	E134517 40026917 R50207576 CQC09002028692	E133481 R50147086 CQC09002028470
Cross Reference	OMRON: G2R/G2RG PANASONIC: JR2/JR2A FUJITSU: FBR-F1/VSB NEC: TP P&B: RKA/RKS	OMRON: G5G PANASONIC: LE	OMRON: G5J PANASONIC: JR1AF-TMP FUJITSU: VR OEG: OMIF
Page	225	229	233

Note: Specification and dimensions in this catalog are subject to change without notice.

POWER RELAY SELECTION CHART

Type	HF102F	HF161F	HF161F-W
Appearance			
Dimensions(L x W x H) mm	30.5 x 16.0 x 23.5	30.4 x 15.9 x 23.3	30.4 x 15.9 x 23.3
Features	<ul style="list-style-type: none"> • Heavy load up to 5000VA • Ideal for motor switching • Withstand inrush current of 80A • PCB & QC layouts available 	<ul style="list-style-type: none"> • 4.5kV dielectric strength (between coil and contacts) • Heavy load up to 6250VA • Ideal for motor switching • PCB layouts available 	<ul style="list-style-type: none"> • 31A switching capable • Applicable to inverter used for photovoltaic power generation systems • Ideal for UPS • 1.5mm contact gap (compliant to European Photovoltaic Standard VDE0126) • The clearance distance between contact and coil is bigger than 6.4mm, the creepage distance is bigger than 8mm.

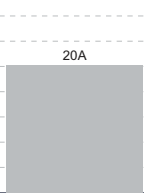
Contact Ratings

Contact Form	1A	1A	1A
Contact Material	AgSnO ₂ , AgCdO	AgSnO ₂ , AgCdO	AgSnO ₂
Max. Switching Current (Resistive load)			
Max. Switching Voltage	250VAC	250VAC	277VAC
Max. Switching Power	6250VA	6250VA	7750VA
Rated Load (Resistive load)	20A 250VAC Motor: 2HP 240VAC	20A 250VAC Motor: 2HP 240VAC	Resistive: 26A 250VAC Inductive: 31A 250VAC

Coil Ratings

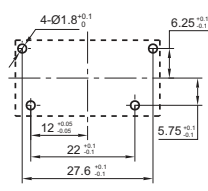
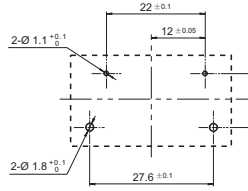
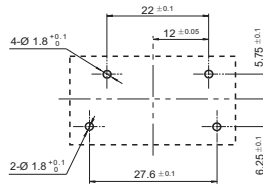

Rated Voltage	5VDC to 48VDC	5VDC to 48VDC	9VDC to 24VDC
Nominal Operating Power	0.9W	0.9W	1.4W

Specifications



Insulation Resistance	1000MΩ	1000MΩ	1000MΩ
Dielectric Strength (Between coil and contacts)	4500VAC	4500VAC	4500VAC
Ambient Temperature	-25°C to 85°C	-40°C to 85°C	-40°C to 85°C (Apply holding voltage to coil, which is 45% to 80% that of rated voltage)
Operate / Release Time max.	20ms / 10ms	20ms / 10ms	20ms / 10ms
Mechanical Endurance min.	2 x 10 ⁶ OPS	2 x 10 ⁶ OPS	1 x 10 ⁶ OPS
Electrical Endurance min.	1 x 10 ⁵ OPS	1 x 10 ⁵ OPS	3 x 10 ⁴ OPS
Layout (Bottom view)			
Terminal Type	PCB, QC	PCB	PCB
Approved Standards	UL/CUL VDE CQC	UL/CUL VDE CQC	UL/CUL VDE CQC
File No.	E134517 40024142 CQC13002098165	E134517 40031410 CQC10002050943	E134517 40031410 CQC10002050943
Cross Reference	OMRON: G4A PANASONIC: LF OEG: PCFN	OMRON: G4A PANASONIC: LF OEG: PCFN	PANASONIC: LF-G OEG: PCFN SOLAR
Page	236	239	242

Note: Specification and dimensions in this catalog are subject to change without notice.

POWER RELAY SELECTION CHART

Type	HF160F	HF166F	HF37F
Appearance			
Dimensions(L x W x H) mm	30.4 x 15.9 x 25.4	50.0 x 27.0 x 20.0	35.2 x 32.2 x 24.0
Features	<ul style="list-style-type: none"> • 4.5kV dielectric strength (between coil and contacts) • Heavy load up to 6250VA • Ideal for motor switching • PCB & QC layouts 	<ul style="list-style-type: none"> • Latching relay • 4mm contact gap available • 25A switching capability • 5kV dielectric strength (between coil and contacts) • Creepage distance between coil and contacts:10mm 	<ul style="list-style-type: none"> • 30A switching capability • 1 Form A configuration • 70A withstands inrush current • TV-15(at 120VAC) available

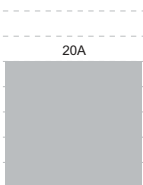
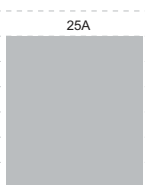
Contact Ratings

Contact Form	1A	1A+1B	1A
Contact Material	AgSnO ₂ , AgCdO	AgSnO ₂	AgSnO ₂ , AgCdO
Max. Switching Current (Resistive load)			
Max. Switching Voltage	250VAC	277VAC	277VAC
Max. Switching Power	6250VA	6925VA	7500VA
Rated Load (Resistive load)	20A 250VAC Motor: 2HP 240VAC	25A 277VAC	30A 250VAC

Coil Ratings

Rated Voltage	5VDC to 48VDC	5VDC to 48VDC	5VDC to 60VDC
Nominal Operating Power	0.9W	1.2W, 2.4W	1.2W

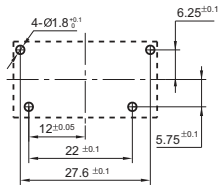
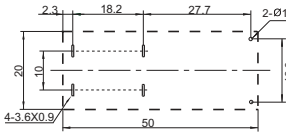
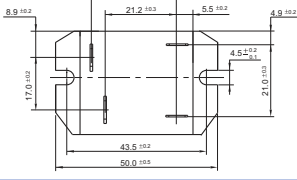

Specifications

Insulation Resistance	1000MΩ	1000MΩ	1000MΩ
Dielectric Strength (Between coil and contacts)	4500VAC	5000VAC	4000VAC
Ambient Temperature	-40°C to 85°C	-40°C to 85°C	-40°C to 70°C
Operate / Release Time max.	20ms / 10ms	25ms / 25ms	20ms / 5ms
Mechanical Endurance min.	2 x 10 ⁶ OPS	6 x 10 ⁵ OPS	5 x 10 ⁶ OPS
Electrical Endurance min.	1 x 10 ⁵ OPS	3 x 10 ⁴ OPS	1 x 10 ⁵ OPS

Layout (Bottom view)			
Terminal Type	PCB, QC	PCB	QC
Approved Standards	UL/CUL VDE CQC	UL/CUL TÜV	UL/CUL VDE CQC
File No.	E134517 40024142 CQC12002072207	E133481 B130453286009	E134517 40025378 CQC13002102287
Cross Reference	OMRON: G4A PANASONIC: JM FUJITSU: FTR-K3/VH OEG: PCF		FUJITSU: VF
Page	245	248	251

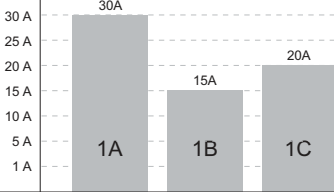
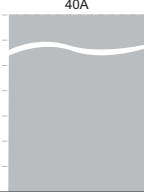
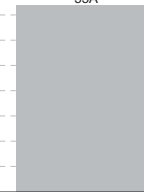
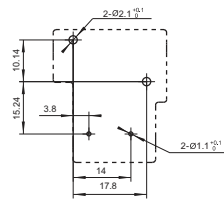
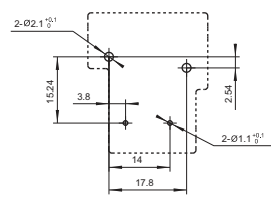
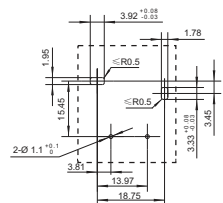

Note: Specification and dimensions in this catalog are subject to change without notice.

POWER RELAY SELECTION CHART

Type	HF165FD	HF165FD-G	HF165F
Appearance			
Dimensions(L x W x H) mm	32.2 x 27.5 x 20.4	32.2 x 27.5 x 20.4	32.2 x 27.4 x 19.4
Features	<ul style="list-style-type: none"> • 30A switching capability • 4kV dielectric strength (between coil and contacts) • Creepage distance: 5.5mm • Product in accordance to IEC 60335-1 available • UL insulation system: Class F 	<ul style="list-style-type: none"> • 40A switching capability • 4kV dielectric strength (between coil and contacts) • Creepage distance: 5.5mm • Product in accordance to IEC 60335-1 available • UL insulation system: Class F 	<ul style="list-style-type: none"> • 35A switching capability • Applicable to inverter used for photovoltaic power generation systems • Ideal for UPS • 1.8mm contact gap(compliant to European Photovoltaic Standard VDE0126) • Low coil holding voltage contributes to saving energy of equipment
Contact Ratings			
Contact Form	1A, 1B, 1C	1A	1A
Contact Material	AgSnO ₂	AgSnO ₂	AgSnO ₂
Max. Switching Current (Resistive load)			
Max. Switching Voltage	277VAC	277VAC	277VAC
Max. Switching Power	8310VA / 4155VA	11080VA	9695VA
Rated Load (Resistive load)	1A: 30A 277VAC 1B: 15A 277VAC 1C: 20A 277VAC/10A 277VAC	40A 277VAC	Resistive: 35A 250VAC Inductive: 35A 277VAC
Coil Ratings			
Rated Voltage	5VDC to 110VDC	5VDC to 110VDC	5VDC to 48VDC
Nominal Operating Power	0.9W	0.9W	2.25W
Specifications			
Insulation Resistance	1000MΩ	1000MΩ	1000MΩ
Dielectric Strength (Between coil and contacts)	4000VAC	4000VAC	4000VAC
Ambient Temperature	-40°C to 85°C	-40°C to 85°C	-40°C to 85°C
Operate / Release Time max.	15ms / 10ms	15ms / 10ms	15ms / 10ms
Mechanical Endurance min.	1 x 10 ⁷ OPS	1 x 10 ⁷ OPS	1 x 10 ⁶ OPS
Electrical Endurance min.	1 x 10 ⁵ OPS	1 x 10 ⁴ OPS	3 x 10 ⁴ OPS
Layout (Bottom view)			
Terminal Type	PCB	PCB	PCB
Approved Standards	UL/CUL VDE CQC	UL/CUL VDE CQC	UL/CUL VDE
File No.	E134517 40043143 CQC15002130956	E134517 40043143 CQC15002130956	E134517 40037289
Cross Reference	OMRON: G8P PANASONIC: JTN/JTV OEG: ORU P&B: T9A/T90	SONGCHUAN: 832HA	P&B: T9S SOLAR
Page	254	258	261

Note: Specification and dimensions in this catalog are subject to change without notice.

POWER RELAY SELECTION CHART

Type	HF105F-1	HF105F-2	HF105F-4
Appearance			
Dimensions(L x W x H) mm	32.3 x 27.1 x 20	32.4 x 27.5 x 27.8	50.0 x 27.2 x 27.8
Features	<ul style="list-style-type: none"> • 40A switching capability • PCB coil terminals, ideal for heavy duty load • 4kV dielectric strength (between coil and contacts) • Heavy load up to 7200VA • Unenclosed, plastic sealed and dust protected types available 	<ul style="list-style-type: none"> • 40A switching capability • PCB coil terminals, ideal for heavy duty load • Heavy load up to 7200VA • Plastic sealed and dust protected types available 	<ul style="list-style-type: none"> • 40A switching capability • 2.5kV dielectric strength (between coil and contacts) • Heavy load up to 7200VA • Plastic sealed and dust protected types available

Contact Ratings

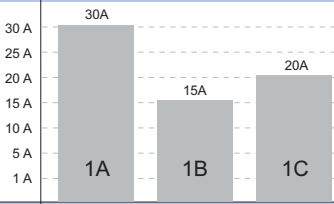
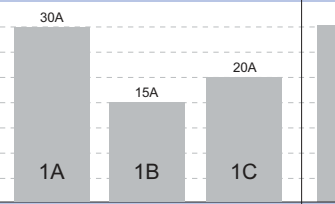
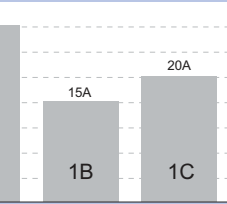
Contact Form	1A, 1B, 1C	1A, 1B, 1C	1A, 1B, 1C
Contact Material	AgSnO ₂ , AgCdO	AgSnO ₂ , AgCdO	AgSnO ₂ , AgCdO
Max. Switching Current (Resistive load)			
Max. Switching Voltage	277VAC / 28VDC	277VAC / 28VDC	277VAC / 28VDC
Max. Switching Power	7200VA / 560W	7200VA / 560W	7200VA / 560W
Rated Load (Resistive load)	1A: 30A 240VAC/20A 28VDC 1B: 15A 240VAC/10A 28VDC 1C: 20A/10A 240VAC/28VDC L Type(1A): 25A 240VAC/20A 28VDC	1A: 30A 240VAC/20A 28VDC 1B: 15A 240VAC/10A 28VDC 1C: 20A/10A 240VAC/28VDC L Type(1A): 25A 240VAC/20A/28VDC	1A: 30A 240VAC/20A 28VDC 1B: 15A 240VAC/10A 28VDC 1C: 20A/10A 240VAC/28VDC L Type(1A): 25A 240VAC/20A/28VDC

Coil Ratings

Rated Voltage	12VAC to 277VAC / 5VDC to 110VDC	12VAC to 277VAC / 5VDC to 110VDC	12VAC to 277VAC / 5VDC to 110VDC
Nominal Operating Power	2.0VA, 0.9W	2.0VA, 0.9W	2.0VA, 0.9W

Specifications

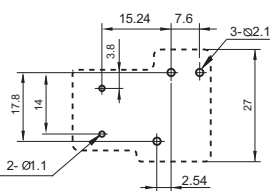
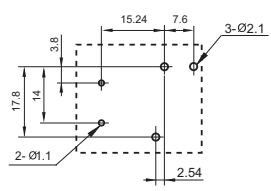
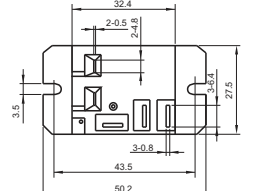

Insulation Resistance	1000MΩ	1000MΩ	1000MΩ
Dielectric Strength (Between coil and contacts)	2500VAC / 4000VAC	2500VAC	2500VAC
Ambient Temperature	DC: -55°C to 85°C AC: -55°C to 60°C	DC: -55°C to 85°C AC: -55°C to 60°C	DC: -55°C to 85°C AC: -55°C to 60°C
Operate / Release Time max.	15ms / 10ms(DC type)	15ms / 10ms(DC type)	15ms / 10ms(DC type)
Mechanical Endurance min.	1 x 10 ⁷ OPS	1 x 10 ⁷ OPS	1 x 10 ⁷ OPS
Electrical Endurance min.	1 x 10 ⁵ OPS	1 x 10 ⁵ OPS	1 x 10 ⁵ OPS

Layout (Bottom view)			
----------------------	---	--	---



Terminal Type	PCB	PCB, QC	QC
Approved Standards	UL/CUL VDE CQC	UL/CUL VDE CQC	UL/CUL VDE CQC
File No.	E134517 40025518(DC Type) CQC09002031229(Ningbo Factory, DC Type) CQC12002071130(Ningbo Factory, AC Type)	E134517 40025518(DC Type) CQC09002031229(DC Type)	E134517 40025518(DC Type) CQC09002031229(DC Type)
Cross Reference	OMRON: G8P PANASONIC: JTN/JTV OEG: ORU P&B: T9A/T90	OMRON: G7G/G8P PANASONIC: JT OEG: ORU P&B: 491/T9A	OMRON: G7G/G8P PANASONIC: JT OEG: ORU P&B: T9A
Page	264	270	274

Note: Specification and dimensions in this catalog are subject to change without notice.

POWER RELAY SELECTION CHART

Type	HF105F-5	HF2100	HF2110 / HF2120
Appearance			
Dimensions(L x W x H) mm	32.4 x 27.3 x 27.8	32.0 x 27.5 x 28.0	28.4 x 23.5 x 15.3
Features	<ul style="list-style-type: none"> • 40A switching capability • PCB coil terminals, ideal for heavy duty load • Heavy load up to 7200VA • 4kV dielectric strength (between coil and contacts) • Plastic sealed and dust protected types available 	<ul style="list-style-type: none"> • PCB coil terminals, ideal for heavy duty load • 2.5kV dielectric strength (between coil and contacts) • Plastic sealed and flux proofed types available 	<ul style="list-style-type: none"> • 30A switching capability • 2.5kV dielectric strength (between coil and contacts) • Plastic sealed and flux proofed types available

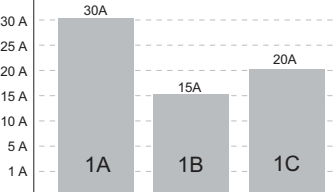
Contact Ratings

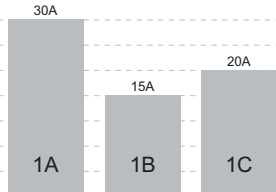
Contact Form	1A, 1B, 1C	1A, 1B, 1C	1A, 1B, 1C
Contact Material	AgSnO ₂ , AgCdO	AgSnO ₂ , AgCdO	AgSnO ₂ , AgCdO
Max. Switching Current (Resistive load)			
Max. Switching Voltage	277VAC / 28VDC	277VAC / 30VDC	277VAC / 30VDC
Max. Switching Power	7200VA / 560W	7200VA / 600W	7200VA / 600W
Rated Load (Resistive load)	1A: 30A 240VAC/20A 28VDC 1B: 15A 240VAC/10A 28VDC 1C: 20A/10A 240VAC/28VDC L Type(1A): 25A 240VAC/20A/28VDC	1A: 30A 240VAC/20A 30VDC 1B: 15A 240VAC/10A 30VDC 1C: 20A/10A 240VAC/30VDC	1A: 30A 240VAC/20A 30VDC 1B: 15A 240VAC/10A 30VDC 1C: 20A/10A 240VAC/30VDC

Coil Ratings

Rated Voltage	12VAC to 277VAC / 5VDC to 110VDC	5VDC to 110VDC	5VDC to 110VDC
Nominal Operating Power	2.0VA, 0.9W	0.9W	0.9W

Specifications

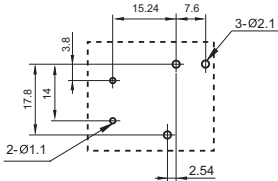
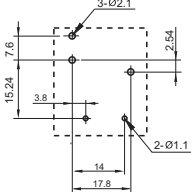
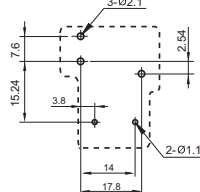

Insulation Resistance	1000MΩ	1000MΩ	1000MΩ
Dielectric Strength (Between coil and contacts)	4000VAC / 2500VAC	2500VAC	2500VAC
Ambient Temperature	DC: -55°C to 85°C AC: -55°C to 60°C	-55°C to 85°C	-55°C to 85°C
Operate / Release Time max.	15ms / 10ms(DC type)	15ms / 10ms	15ms / 10ms
Mechanical Endurance min.	1 x 10 ⁷ OPS	1 x 10 ⁷ OPS	1 x 10 ⁷ OPS
Electrical Endurance min.	1 x 10 ⁵ OPS	1 x 10 ⁵ OPS (at 30A 240VAC)	1 x 10 ⁵ OPS (at 30A 240VAC)

Layout (Bottom view)			
----------------------	---	--	---



Terminal Type	PCB, QC	PCB, QC	PCB, QC
Approved Standards	UL/CUL VDE CQC	UL/CUL TÜV CQC	UL/CUL CQC
File No.	E134517 40025518(DC Type) CQC09002031229(DC Type)	E134517 R50153835 CQC10002049166	E134517 CQC10002049166
Cross Reference	OMRON: G7G/G8P PANASONIC: JTN OEG: ORU P&B: T90/T9A	OMRON: G7G PANASONIC: JT P&B: 491/T9A ZETTLER: AZ2100	OMRON: G7G PANASONIC: JT NEC: CT P&B: 491/T90 ZETTLER: AZ2110/AZ2120
Page	278	282	286

Note: Specification and dimensions in this catalog are subject to change without notice.

POWER RELAY SELECTION CHART

Type	HF2150 / HF2151	HF2160	HF116F-1
Appearance			
Dimensions(L x W x H) mm	31.8 x 27.0 x 19.1	32.0 x 27.5 x 19.8	50.5 x 32.9 x 36.0
Features	<ul style="list-style-type: none"> • 30A switching capability • 2.5kV dielectric strength (between coil and contacts) • Heavy load up to 7200VA • Plastic sealed and flux proofed type available 	<ul style="list-style-type: none"> • 30A switching capability • PCB coil terminals, ideal for heavy duty load • 2.5KV dielectric strength (between coil and contacts) • Plastic sealed and Dust proofed types available 	<ul style="list-style-type: none"> • 30A switching capability • 4kV dielectric strength (between coil and contacts) • Heavy load up to 8310VA • 3mm contact gap available

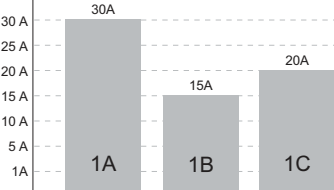
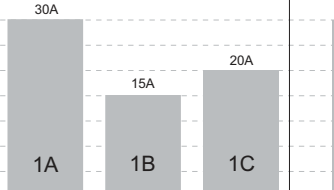
Contact Ratings

Contact Form	1A, 1B, 1C	1A, 1B, 1C	1A, 2A
Contact Material	AgSnO ₂ , AgCdO	AgSnO ₂ , AgCdO	AgSnO ₂ , AgCdO
Max. Switching Current (Resistive load)			
Max. Switching Voltage	277VAC / 30VDC	277VAC / 30VDC	277VAC
Max. Switching Power	7200VA / 600W	7200VA / 600W	8310VA
Rated Load (Resistive load)	1A: 30A 240VAC/20A 30VDC 1B: 15A 240VAC/10A 30VDC 1C: 20A/10A 240VAC/30VDC	1A: 30A 240VAC/20A 30VDC 1B: 15A 240VAC/10A 30VDC 1C: 20A/10A 240VAC/30VDC	1A: 30A 240VAC/30A 277VAC 2A: 25A 240VAC/25A 277VAC

Coil Ratings

Rated Voltage	5VDC to 110VDC	5VDC to 110VDC	6VAC to 220/240VAC 3VDC to 200VDC
Nominal Operating Power	0.9W	0.9W	2.7VA, 1.9W

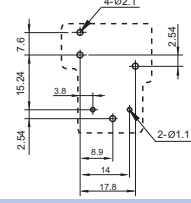
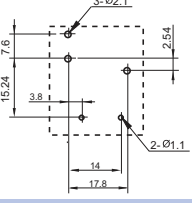
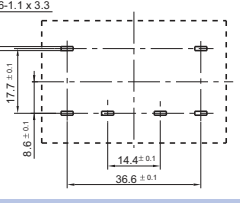

Specifications

Insulation Resistance	1000MΩ	1000MΩ	1000MΩ
Dielectric Strength (Between coil and contacts)	2500VAC	2500VAC	4000VAC
Ambient Temperature	-55°C to 85°C	-55°C to 85°C	-55°C to 70°C
Operate / Release Time max.	15ms / 10ms	15ms / 10ms	30ms / 30ms
Mechanical Endurance min.	1 x 10 ⁷ OPS	1 x 10 ⁷ OPS	1 x 10 ⁷ OPS
Electrical Endurance min.	1 x 10 ⁵ OPS (at 30A 240VAC)	1 x 10 ⁵ OPS (at 30A 240VAC)	1 x 10 ⁵ OPS

Layout (Bottom view)			
Terminal Type	PCB	PCB, QC	PCB, QC, Panel Mount
Approved Standards	UL/CUL TÜV CQC	UL/CUL TÜV CQC	UL/CUL TÜV CQC
File No.	E134517 R50153835 CQC10002049166	E134517 R50153835 CQC10002049166	E134517 R50154722 CQC09002031231(DC Type)
Cross Reference	OMRON: G7G PANASONIC: JTN/JTV NEC: CT P&B: T9A/T90 ZETTLER: AZ2150/AZ2151	PANASONIC: JT NEC: CT P&B: T9A/T90 ZETTLER: AZ2160	OMRON: G7L PANASONIC: HE
Page	292	296	300

Note: Specification and dimensions in this catalog are subject to change without notice.

POWER RELAY SELECTION CHART

Type	HF116F-2	HF116F-3	HF116F-G
Appearance			
Dimensions(L x W x H) mm	51.5 x 34.9 x 36.0	50.5 x 32.9 x 51.0	51.5 x 34.9 x 36.0
Features	<ul style="list-style-type: none"> • 30A switching capability • 4kV dielectric strength (between coil and contacts) • 3mm contact gap available 	<ul style="list-style-type: none"> • 30A switching capability • 4kV dielectric strength (between coil and contacts) • Heavy load up to 8310VA • 3mm contact gap available 	<ul style="list-style-type: none"> • 50A switching capability • Applicable to inverter used for photovoltaic power generation systems • 4kV dielectric strength (between coil and contacts) • 3mm contact gap (compliant to European Photovoltaic Standard VDE0126, compliant to IEC 62109-2:2011)

Contact Ratings

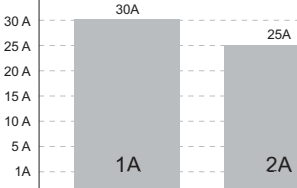
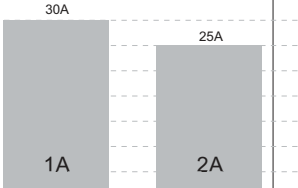
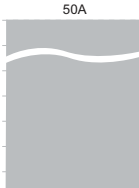
Contact Form	1A, 2A	1A, 2A	1A, 2A
Contact Material	AgSnO ₂ , AgCdO	AgSnO ₂ , AgCdO	AgSnO ₂ , AgNi
Max. Switching Current (Resistive load)			
Max. Switching Voltage	277VAC	277VAC	277VAC
Max. Switching Power	8310VA	8310VA	15235VA
Rated Load (Resistive load)	1A: 30A 240VAC/30A 277VAC 2A: 25A 240VAC/25A 277VAC	1A: 30A 240VAC/30A 277VAC 2A: 25A 240VAC/25A 277VAC	50A 277VAC

Coil Ratings

Rated Voltage	6VAC to 220/240VAC 3VDC to 200VDC	6VAC to 220/240VAC 3VDC to 200VDC	3VDC to 48VDC
Nominal Operating Power	2.7VA, 1.9W	2.7VA, 1.9W	3.2W

Specifications

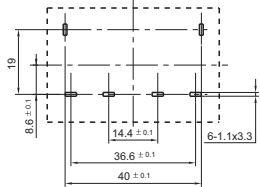
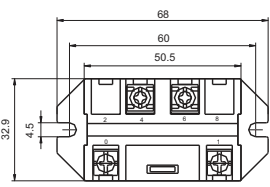
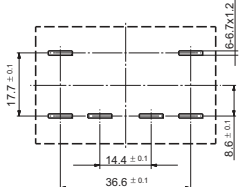

Insulation Resistance	1000MΩ	1000MΩ	1000MΩ
Dielectric Strength (Between coil and contacts)	4000VAC	4000VAC	4000VAC
Ambient Temperature	-55°C to 70°C	-55°C to 70°C	-40°C to 85°C
Operate / Release Time max.	30ms / 30ms	30ms / 30ms	30ms / 30ms
Mechanical Endurance min.	1 x 10 ⁷ OPS	1 x 10 ⁷ OPS	1 x 10 ⁶ OPS
Electrical Endurance min.	1 x 10 ⁵ OPS	1 x 10 ⁵ OPS	3 x 10 ⁴ OPS

Layout (Bottom view)			
----------------------	---	--	---



Terminal Type	PCB, QC, Panel Mount	Screw	PCB
Approved Standards	UL/CUL TÜV CQC	UL/CUL TÜV CQC	UL/CUL TÜV
File No.	E134517 R50154722 CQC09002031231(DC Type)	E134517 R50154722 CQC09002031231(DC Type)	E134517 R50154722
Cross Reference	OMRON: G7L PANASONIC: HE	OMRON: G7L PANASONIC: HE	PANASONIC: HE SONGCHUAN: 510H
Page	304	308	312

Note: Specification and dimensions in this catalog are subject to change without notice.

POWER RELAY SELECTION CHART

Type	HF116F-80	HF92F	HF84F
Appearance			
Dimensions(L x W x H) mm	50.5 x 32.9 x 36	52.0 x 33.7 x 26.7	47.0 x 32.0 x 28.5
Features	<ul style="list-style-type: none"> • 80A switching capability • Applicable to solar photovoltaic inverter • Applicable to UPS • 3mm contact gap (compliant to European Photovoltaic Standard VDE0126, compliant to IEC 62109-2-2011) • 4kV dielectric strength (between coil and contacts) 	<ul style="list-style-type: none"> • 30A switching capability • Creepage distance: 8mm • 4kV dielectric strength (between coil and contacts) • Plastic sealed and flux proofed types • PCB & QC layouts 	<ul style="list-style-type: none"> • 16A switching capability • 2.5kV dielectric strength (between coil and contacts) • Panel mount, various terminal types

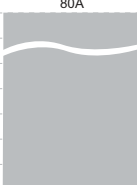
Contact Ratings

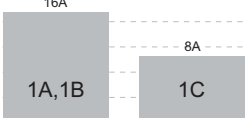
Contact Form	1A	2A, 2C	1A, 1B, 1C
Contact Material	AgSnO ₂ , AgNi	AgSnO ₂ , AgCdO	AgCe
Max. Switching Current (Resistive load)			
Max. Switching Voltage	277VAC	277VAC	240VAC
Max. Switching Power	24930VA	8310VA	3840VA
Rated Load (Resistive load)	80A 250VAC	NO: 30A 250VAC/30A 277VAC NC: 3A 250VAC/3A 277VAC	1A, 1B: 16A 120/240VAC 1C: 8A 120/240VAC

Coil Ratings

Rated Voltage	3VDC to 48VDC	24VAC to 277VAC 5VDC to 110VDC	6VAC to 277VAC / 6VDC to 120VDC
Nominal Operating Power	3.2W	4.0VA, 1.7W	3.5VA, 2.1W

Specifications

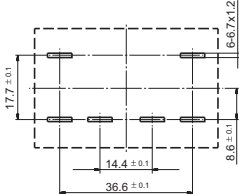
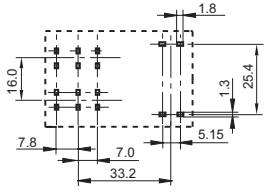
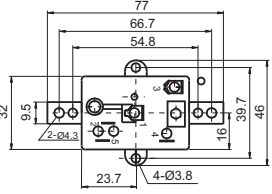

Insulation Resistance	1000MΩ	1000MΩ	500MΩ
Dielectric Strength (Between coil and contacts)	4000VAC	4000VAC	2500VAC
Ambient Temperature	-40°C to 85°C	AC : -40°C to 65°C DC : -40°C to 85°C	-40°C to 65°C
Operate / Release Time max.	30ms / 30ms	25ms / 25ms(DC type)	25ms / 25ms
Mechanical Endurance min.	1 x 10 ⁶ OPS	5 x 10 ⁶ OPS	1 x 10 ⁶ OPS
Electrical Endurance min.	6 x 10 ³ OPS	1 x 10 ⁵ OPS	1 x 10 ⁵ OPS (at 16A 250VAC)

Layout (Bottom view)			
----------------------	---	--	---

Terminal Type	PCB	PCB, QC	QC
Approved Standards	UL/CUL TÜV	UL/CUL VDE CQC	UL/CUL
File No.	E134517 R50154722	E134517 40016109 CQC09002037814(DC type)	E134517
Cross Reference	PANASONIC: HE SONGCHUAN: 511E	P&B, SCHRACK: T92 FEME: CS/CF30	WHITE RODGERS 90-290 to 295 90-203, 204, 205
Page	316	318	322

Note: Specification and dimensions in this catalog are subject to change without notice.

POWER RELAY SELECTION CHART

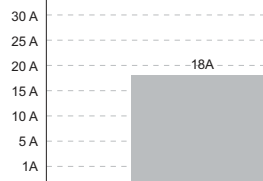
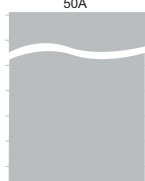
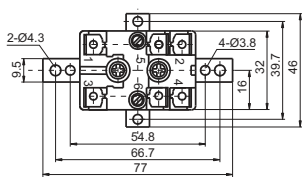
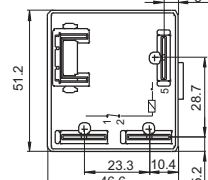
Type	HF94F	HF8565	
Appearance			
Dimensions(L x W x H) mm	47.0 x 32.0 x 28.5	51.2 x 46.6 x 36.5	
Features	<ul style="list-style-type: none"> • 25A switching capability • 2kV dielectric strength (between coil and contacts) • Panel mount, various terminal types 	<ul style="list-style-type: none"> • Motor start potential relay • 50A switching capability • 1 Form B configurations • 250" quick connect termination • Variety of mounting positions 	
Contact Ratings			
Contact Form	1A, 1B, 1C, 1A+1B	1B	
Contact Material	AgCe, AgCdO	AgCdO	
Max. Switching Current (Resistive load)			
Max. Switching Voltage	277VAC		
Max. Switching Power	4986VA		
Rated Load (Resistive load)	18A 277VAC	16A(make and break) 400VAC 35A(break only) 400VAC 50A(break only) 400VAC	
Coil Ratings			
Rated Voltage	6VAC to 277VAC / 6VDC to 120VDC		
Nominal Operating Power	4.0VA, 2.4W	5.0VA	
Specifications			
Insulation Resistance	500MΩ		
Dielectric Strength (Between coil and contacts)	2000VAC		
Ambient Temperature	-40°C to 65°C		
Operate / Release Time max.	25ms / 25ms		
Mechanical Endurance min.	1 x 10 ⁶ OPS	7.5 x 10 ⁵ OPS	
Electrical Endurance min.	5 x 10 ⁴ OPS (at 25A 277VAC)	5 x 10 ⁵ OPS (at 16A 400VAC)	
Layout (Bottom view)			
Terminal Type	QC		
Approved Standards	UL/CUL		
File No.	E134517	SA13318	
Cross Reference	WHITE RODGERS 90-360, 362, 364 90-370, 372, 374 90-380, 382, 384	GE: 3ARR22 ELECTRICA: RVA	
Page	324	327	

Note: Specification and dimensions in this catalog are subject to change without notice.

HFD23

SUBMINIATURE SIGNAL RELAY



File No.:E133481



File No.:CQC09002035070

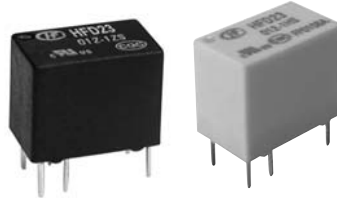

Features

- Max.4A switching capability
- High sensitive: 150mW
- 1 Form C configuration
- Plastic sealed type available
- Environmental friendly product (RoHS compliant)
- Outline Dimensions: (12.5 x 7.5 x 10.0) mm

CONTACT DATA

Contact arrangement	1A	1C
Contact resistance	100mΩ max. (at 10mA 30mVDC)	
Contact material	AgNi +Au plated	
Contact rating (Res. load)	1A 125VAC/2A 30VDC	0.5A 125VAC/1A 30VDC
Max. switching voltage	125VAC / 60VDC	
Max. switching current	4A	2A
Max. switching power	125VA / 60W	62.5VA / 30W
Min. applicable load ¹⁾	1mA 5V	
Mechanical endurance	1 x 10 ⁷ OPS	
Electrical endurance ²⁾	9 x 10 ⁴ OPS (1H:1A 125VAC; 1Z:0.5A 125VAC, Resistive load., Room temp., 1s on 9s off)	

Notes: 1) Min. applicable load is reference value. Please perform the confirmation test with the actual load before production since reference value may change according to switching frequencies, environmental conditions and expected contact resistance and reliability.
2) Electric endurance data are collected in the NO or NC contact test.

CHARACTERISTICS

Insulation resistance	1000MΩ (at 500VDC)	
Dielectric strength	Between coil & contacts	1000VAC 1min
	Between open contacts	500VAC 1min
Operate time (at nomi. volt.)	5ms max.	
Release time (at nomi. volt.)	5ms max.	
Temperature rise (at nomi.volt.)	65K max.	
Vibration resistance	10Hz to 55Hz 3.3mm DA	
Shock resistance	Functional	196m/s ²
	Destructive	980m/s ²
Humidity	5% to 98% RH	
Ambient temperature	-40°C to 70°C	
Unit weight	Approx. 2.2g	
Termination	PCB (DIP)	
Construction	Plastic sealed	

Notes: 1) The data shown above are initial values.
2) UL insulation system: Class A

COIL

Coil power	Sensitive: Approx. 150mW; Standard: Approx. 200mW
------------	--

COIL DATA

at 23°C

Standard type

Nominal Voltage VDC	Pick-up Voltage VDC max.	Drop-out Voltage VDC min.	Max. Voltage VDC	Coil Resistance Ω
1.5	1.20	0.15	2.25	11.3 x (1±10%)
2.4	1.92	0.24	3.6	28.8 x (1±10%)
3	2.40	0.30	4.5	45 x (1±10%)
3.5	3.60	0.45	5.75	101.3 x (1±10%)
5	4.00	0.50	7.5	125 x (1±10%)
6	4.80	0.60	9.0	180 x (1±10%)
9	7.20	0.90	13.5	405 x (1±10%)
12	9.60	1.20	18.0	720 x (1±10%)
24	19.20	2.40	36.0	2880 x (1±15%)

Sensitive type

Nominal Voltage VDC	Pick-up Voltage VDC max.	Drop-out Voltage VDC min.	Max. Voltage VDC	Coil Resistance Ω
1.5	1.20	0.15	2.25	15 x (1±10%)
2.4	1.90	0.24	3.6	38.4 x (1±10%)
3	2.40	0.30	4.5	60 x (1±10%)
4.5	3.60	0.45	5.75	135 x (1±10%)
5	4.00	0.50	7.5	167 x (1±10%)
6	4.80	0.60	9.0	240 x (1±10%)
9	7.20	0.90	13.5	540 x (1±10%)
12	9.60	1.20	18.0	960 x (1±10%)
24	19.20	2.40	36.0	3840 x (1±15%)

Notes: 1) When user's requirements can't be found in the above table, special order allowed.

2) In case 5V of transistor drive circuit, it is recommended to use 4.5V type relay, and 3V to use 2.4V type relay.

SAFETY APPROVAL RATINGS

UL/CUL	1H type: 1A 30VDC 2A 30VDC 1A 125VAC	1Z type: 1A 30VDC 0.3A 60VDC 0.5A 125VAC
--------	--	--

Notes: 1) All values unspecified are at room temperature.

2) Only typical loads are listed above. Other load specifications can be available upon request.



HONGFA RELAY

ISO9001, ISO/TS16949, ISO14001, OHSAS18001, IECQ QC 080000 CERTIFIED

ORDERING INFORMATION

Type	HFD23 / 012 -1Z S (XXX)
Coil voltage	1.5, 2.4, 3, 4.5, 5, 6, 9, 12, 24VDC
Contact arrangement	1H: 1 Form A 1Z: 1 Form C
Coil power	S: Sensitive type P: Standard type
Special code ²⁾	XXX: Customer special requirement Nil: Standard

Notes: 1) Contact is recommended for suitable condition and specifications if water cleaning or surface process is involved in assembling relays on PCB.

2) The customer special requirement express as special code after evaluating by Hongfa.

OUTLINE DIMENSIONS, WIRING DIAGRAM AND PC BOARD LAYOUT

Unit: mm

Outline Dimensions

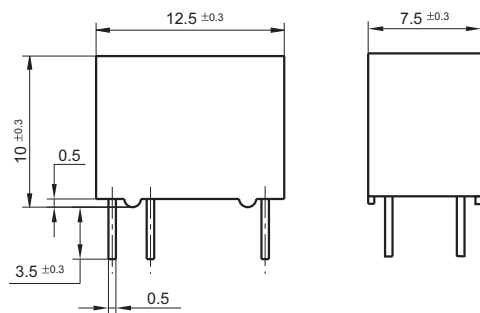

Wiring Diagram
(Bottom view)

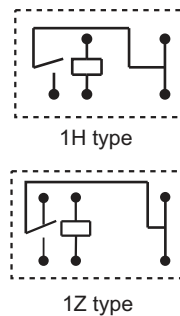

PCB Layout
(Bottom view)

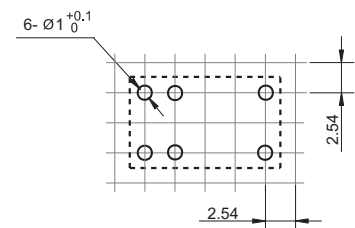

- Remark: 1) In case of no tolerance shown in outline dimension: outline dimension $\leq 1\text{mm}$, tolerance should be $\pm 0.2\text{mm}$; outline dimension $> 1\text{mm}$ and $\leq 5\text{mm}$, tolerance should be $\pm 0.3\text{mm}$; outline dimension $> 5\text{mm}$, tolerance should be $\pm 0.4\text{mm}$.
- 2) The tolerance without indicating for PCB layout is always $\pm 0.1\text{mm}$.
- 3) The width of the gridding is 2.54mm.

CHARACTERISTIC CURVES

MAXIMUM SWITCHING POWER

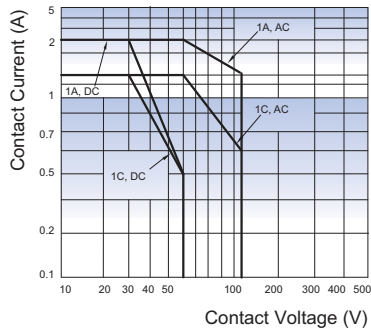

ENDURANCE CURVE

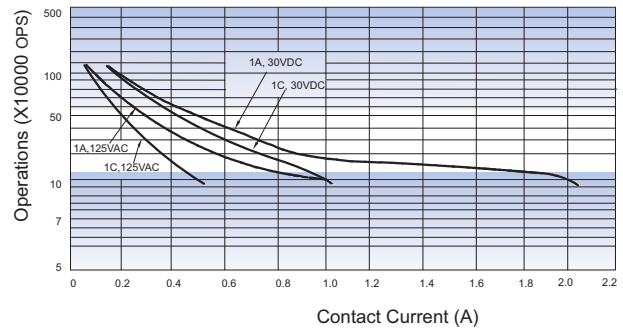

Test conditions:

Resistive load, Room temp., 1s on 9s off.

Notice

- 1) To avoid using relays under strong magnetic field which will change the parameters of relays such as pick-up voltage and drop-out voltage.
- 2) The relay may be damaged because of falling or when shocking conditions exceed the requirement.
- 3) Contact is recommended for suitable condition and specifications if water cleaning or surface process is involved in assembling relays on PCB.
- 4) Regarding the plastic sealed relay, we should leave it cooling naturally until below 40°C after welding, then clean it and deal with coating, remarkably the temperature of solvents should also be controlled below 40°C. Please avoid cleaning the relay by ultrasonic, avoid using the solvents like gasoline, Freon, and so on, which would affect the configuration of relay or influence the environment.
- 5) Energizing coil with rated voltage is basic for normal operation of a relay, please make sure the energized voltage to relay coil have reached the rated voltage. Regarding latching relay, in order to maintain the "set" or "reset" status, impulse width of the rated voltage applied to coil should be more than 5 times of "set" or "reset" time.
- 6) About preferable condition of operation, storage and transportation, please refer to "Explanation to terminology and guidelines of relay".

Disclaimer

The specification is for reference only. See to "Terminology and Guidelines" for more information. Specifications subject to change without notice. We could not evaluate all the performance and all the parameters for every possible application. Thus the user should be in a right position to choose the suitable product for their own application. If there is any query, please contact Hongfa for the technical service. However, it is the user's responsibility to determine which product should be used only.

HFD41/D41A

SUBMINIATURE SIGNAL RELAY



File No.: E133481



File No.: R50265409
(Only HFD41A)



File No.: CQC15002123047 (Only HFD41A)

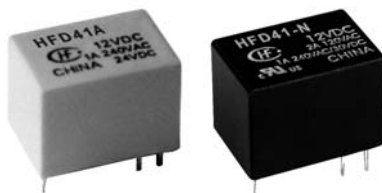

Features

- 5A switching capability
- 1 Form C configuration
- Standard PCB layout
- Plastic sealed and flux proofed types available
- UL insulation system: Class F available
- Environmental friendly product (RoHS compliant)
- Outline Dimensions: (15.7 x 11.0 x 12.0) mm

CONTACT DATA

Contact arrangement	1C
Contact resistance	100mΩ max. (at 1A 6VDC)
Contact material	AgNi, AgCdO
Contact rating (Res. load)	1A 120VAC, 1A 240VAC / 30VDC 3A 120VAC 2A 120VAC, 5A 120VAC
Max. switching voltage	240VAC / 30VDC
Max. switching current	5A
Max. switching power	600VA / 30W
Mechanical endurance	1 x 10 ⁷ OPS
Electrical endurance	9.9 x 10 ⁴ OPS (1A 120VAC, 1A 30VDC, Resistive load, Room temp., 1s on 9s off)

CHARACTERISTICS

Insulation resistance	100MΩ (at 500VDC)	
Dielectric strength	Between coil & contacts	1000VAC 1min
	Between open contacts	500VAC 1min
Operate time (at nomi. volt.)	10ms max.	
Release time (at nomi. volt.)	5ms max.	
Shock resistance	Functional	98m/s ²
	Destructive	980m/s ²
Vibration resistance	10Hz to 55Hz 1.5mm DA	
Humidity	5% to 85% RH	
Ambient temperature	-25°C to 70°C	
Termination	PCB (DIP)	
Unit weight	Approx. 5g	
Construction	Plastic sealed, Flux proofed	

- Notes:** 1) The data shown above are initial values.
2) Please find coil temperature curve in the characteristic curves below.
3) UL insulation system: Class F, Class B.

COIL

Coil power	B type: Approx. 450mW; N type: Approx. 360mW; H type: Approx. 200mW
------------	---

COIL DATA

at 23°C

Nominal Voltage VDC	Pick-up Voltage VDC max.	Drop-out Voltage VDC min.	Max. Voltage VDC	Coil Resistance x (1±10%) Ω		
				H	N	B
3	2.3	0.3	3.9	45	25	20
5	3.8	0.5	6.5	120	70	56
6	4.5	0.6	7.8	180	100	80
9	6.8	0.9	11.7	400	220	180
12	9.0	1.2	15.6	700	400	320
24	18.0	2.4	31.2	2800	1600	1280

SAFETY APPROVAL RATINGS

UL/CUL	1A 120VAC, 1A 240VAC/30VDC 2A 120VAC, 3A 120VAC 5A 120VAC
TÜV	1A 120VAC/30VDC

- Notes:** 1) All values unspecified are at room temperature.
2) Only typical loads are listed above. Other load specifications can be available upon request.



HONGFA RELAY

ISO9001, ISO/TS16949, ISO14001, OHSAS18001, IECQ QC 080000 CERTIFIED

ORDERING INFORMATION

Type	HFD41 /12VDC -N S G F 3 (XXX) HFD41A					
Coil voltage	3, 5, 6, 9, 12, 24 VDC					
Coil power	H: 200mW	N: 360mW	B: 450mW			
Construction ¹⁾²⁾	S: Plastic sealed		Nil: Flux proofed			
Contact plating	G: Gold plated ³⁾		Nil: No gold plated			
Insulation standard	F: Class F		Nil: Class B			
Contact capacity ³⁾	3: 3A (AgCdO, riveted contact)		5: 5A (AgCdO, riveted contact)		Nil: 1A, 2A (AgNi, threaded contact)	
Special code ⁴⁾	XXX: Customer special requirement		Nil: Standard			

- Notes:** 1) Under the ambience with dangerous gas like H₂S, SO₂ or NO₂, plastic sealed type is recommended; Please test the relay in real applications. If the ambience allows, flux proofed type is preferentially recommended.
 2) Contact is recommended for suitable condition and specifications if water cleaning or surface process is involved in assembling relays on PCB.
 3) For gold plated type, the min. switching current and min. switching voltage is 10mA 5VDC. For 3A, 5A load products, only gold-plated contact is available.
 4) The customer special requirement express as special code after evaluating by Hongfa.

OUTLINE DIMENSIONS, WIRING DIAGRAM AND PC BOARD LAYOUT

Unit: mm

Outline Dimensions

HFD41

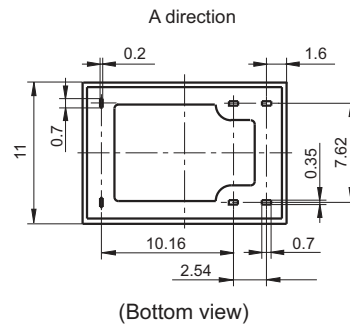
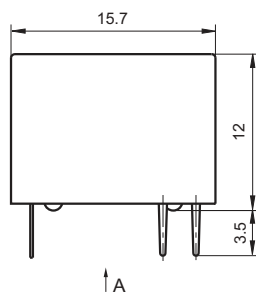

Wiring Diagram
(Bottom view)

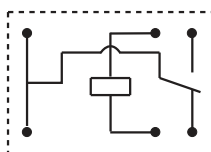

PCB Layout
(Bottom view)

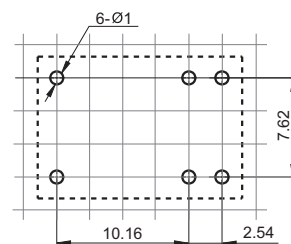

HFD41A

Outline Dimensions

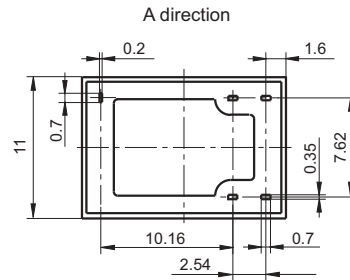
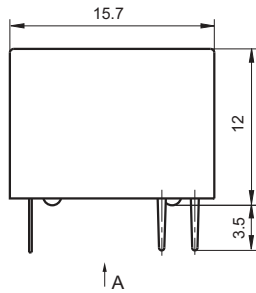

(Bottom view)

**Wiring Diagram
(Bottom view)**

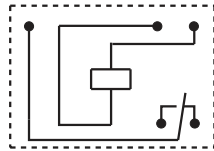

**PCB Layout
(Bottom view)**

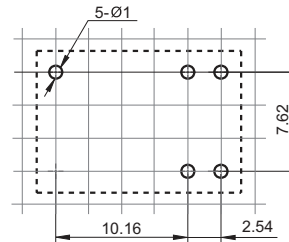

- Remark: 1) In case of no tolerance shown in outline dimension: outline dimension $\leq 1\text{mm}$, tolerance should be $\pm 0.2\text{mm}$; outline dimension $> 1\text{mm}$ and $\leq 5\text{mm}$, tolerance should be $\pm 0.3\text{mm}$; outline dimension $> 5\text{mm}$, tolerance should be $\pm 0.4\text{mm}$.
 2) The tolerance without indicating for PCB layout is always $\pm 0.1\text{mm}$.
 3) The width of the gridding is 2.54mm.

CHARACTERISTIC CURVES

ENDURANCE CURVE

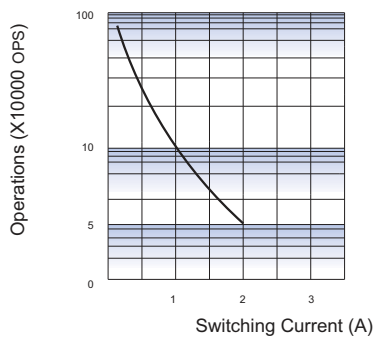

COIL TEMPERATURE RISE

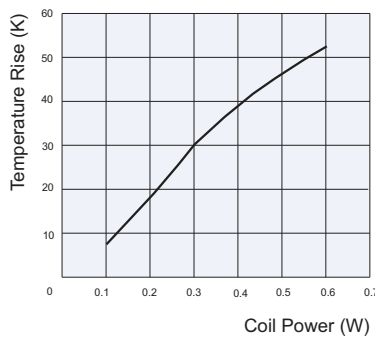

OPERATE TIME

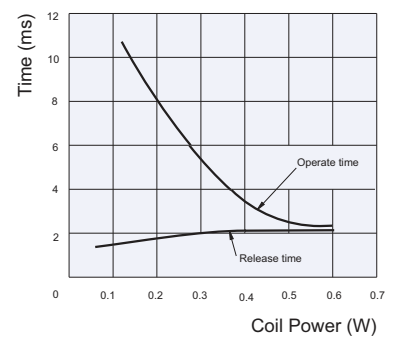

Test conditions:

Resistive load, Room temp., 1s on 9s off.

Disclaimer

The specification is for reference only. See to "Terminology and Guidelines" for more information. Specifications subject to change without notice. We could not evaluate all the performance and all the parameters for every possible application. Thus the user should be in a right position to choose the suitable product for their own application. If there is any query, please contact Hongfa for the technical service. However, it is the user's responsibility to determine which product should be used only.

HFD27

SUBMINIATURE DIP RELAY



File No.:E133481



File No.:R50316277



File No.:CQC09002033393



Features

- 2 Form C configuration
- High switching capacity: 125VA/60W
- Matching 16 pin IC socket
- Bifurcated contacts
- Epoxy sealed for automatic-wave soldering and cleaning
- Environmental friendly product (RoHS compliant)
- Outline Dimensions: (20.2 x 10.0 x 11.5) mm

CONTACT DATA

Contact arrangement	2C
Contact resistance	100mΩ max. (at 10mA 30mVDC)
Contact material	AgNi + Au plated
Contact rating (Res. load)	1A 125VAC, 2A 30VDC
Max. switching voltage	240VAC / 120VDC
Max. switching current	2A
Max. switching power	125VA / 60W
Min. applicable load ¹⁾	10mV 10μA
Mechanical endurance	1x10 ⁸ OPS
Electrical endurance ²⁾	1 x 10 ⁵ OPS (1A 125VAC, Resistive load, at 85°C, 1s on 9s off)

Notes: 1) Min. applicable load is reference value. Please perform the confirmation test with the actual load before production since reference value may change according to switching frequencies, environmental conditions and expected contact resistance and reliability.

2) Electric endurance data are collected in one pair CO contact test.

CHARACTERISTICS

Insulation resistance	1000MΩ (at 500VDC)
Dielectric strength	Between coil & contacts 1500VAC 1min
	Between open contacts M, S type: 1000VAC 1min H type: 750VAC 1min
Operate time (at nomi. volt.)	7ms max.
Release time (at nomi. volt.)	4ms max.
Ambient temperature	-40°C to 85°C
Humidity	5% to 85% RH
Vibration resistance	10Hz to 55Hz 1.5mm DA
Shock resistance	Functional 196m/s ²
	Destructive 980m/s ²
Termination	PCB (DIP)
Unit weight	Approx. 5g
Construction	Plastic sealed

Notes: 1) The data shown above are initial values.

2) UL insulation system: Class A

COIL

Coil power	Standard: Approx. 280mW to 580mW
	Sensitive: Approx. 200mW
	High Sensitive: Approx. 150mW
Temperature rise	65K max.

COIL DATA

at 23°C

Standard type (280mW to 580mW)

Coil Code	Coil Voltage VDC	Pick-up Voltage VDC max.	Drop-out Voltage VDC min.	Max. Voltage VDC	Coil Resistance Ω
003-M	3	2.25	0.3	4.5	30 x (1±10%)
005-M	5	3.75	0.5	8.0	90 x (1±10%)
006-M	6	4.50	0.6	10.0	130 x (1±10%)
009-M	9	6.80	0.9	14.5	280 x (1±10%)
012-M	12	9.00	1.2	18.5	450 x (1±10%)
015-M	15	11.3	1.5	22.0	625 x (1±10%)
024-M	24	18.0	2.4	35.5	1600 x (1±10%)
048-M	48	36.0	4.8	56.0	4000 x (1±10%)

Sensitive type (200mW)

Coil Code	Coil Voltage VDC	Pick-up Voltage VDC max.	Drop-out Voltage VDC min.	Max. Voltage VDC	Coil Resistance Ω
003-S	3	2.25	0.3	6	45 x (1±10%)
005-S	5	3.75	0.5	10	125 x (1±10%)
006-S	6	4.50	0.6	12	180 x (1±10%)
009-S	9	6.80	0.9	18	405 x (1±10%)
012-S	12	9.00	1.2	24	720 x (1±10%)
015-S	15	11.3	1.5	30	1125 x (1±10%)
024-S	24	18.0	2.4	48	2880 x (1±10%)



HONGFA RELAY

ISO9001, ISO/TS16949, ISO14001, OHSAS18001, IECQ QC 080000 CERTIFIED

COIL DATA

at 23°C

High sensitive type (150mW)

Coil Code	Coil Voltage VDC	Pick-up Voltage VDC	Drop-out Voltage VDC	Max. Voltage VDC	Coil Resistance Ω
003-H	3	2.4	0.3	7.0	60 x (1±10%)
005-H	5	4.0	0.5	11.5	167 x (1±10%)
006-H	6	4.8	0.6	13.8	240 x (1±10%)
009-H	9	7.2	0.9	20.8	540 x (1±10%)
012-H	12	9.6	1.2	27.7	960 x (1±10%)
015-H	15	12.0	1.5	34.6	1500 x (1±10%)
024-H	24	19.2	2.4	55.2	3840 x (1±10%)

Notes: 1) When user's requirements can't be found in the above table, special order allowed.

2) In case 5V of transistor drive circuit, it is recommended to use 4.5V type relay, and 3V to use 2.4V type relay.

SAFETY APPROVAL RATINGS

UL/CUL	2A 30VDC
	1A 125VAC
TÜV	2A 30VDC
	1A 125VAC

Notes: 1) All values unspecified are at 85°C.

2) Only typical loads are listed above. Other load specifications can be available upon request.

ORDERING INFORMATION

Type	HFD27 / 012 -S (XXX)		
Coil voltage	3, 5, 6, 9, 12, 15, 24, 48VDC ¹⁾		
Coil power	M: Standard (280mW to 580mW) S: Sensitive (200mW) H: High sensitive (150mW)		
Special code ²⁾	XXX: Customer special requirement	Nil: Standard	

Notes: 1) 48VDC coil voltage is only for standard version.

2) The customer special requirement express as special code after evaluating by Hongfa.

OUTLINE DIMENSIONS, WIRING DIAGRAM AND PC BOARD LAYOUT

Unit: mm

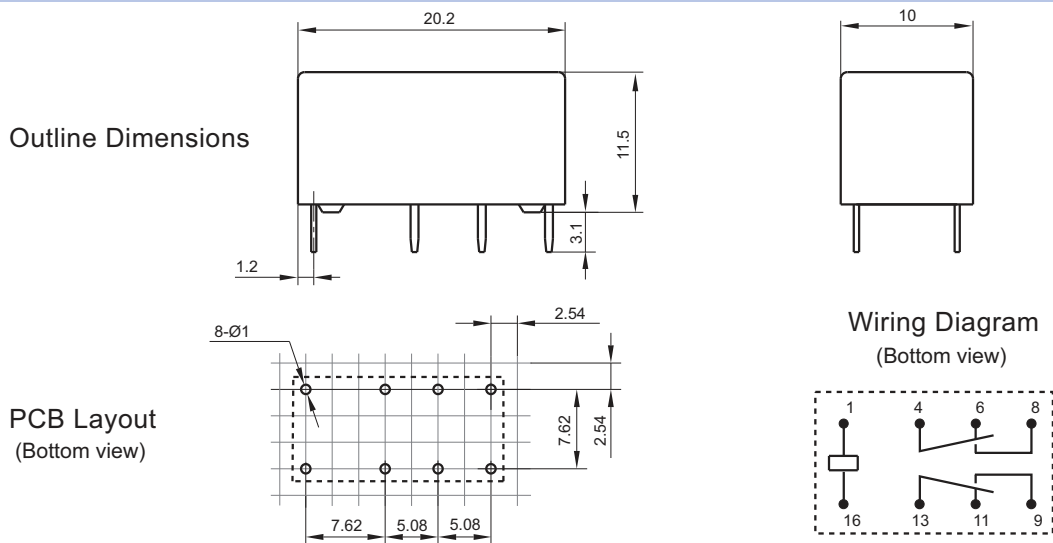

Remark: 1) In case of no tolerance shown in outline dimension: outline dimension ≤ 1 mm, tolerance should be ± 0.2 mm; outline dimension > 1 mm and ≤ 5 mm, tolerance should be ± 0.3 mm; outline dimension > 5 mm, tolerance should be ± 0.4 mm.

2) The tolerance without indicating for PCB layout is always ± 0.1 mm.

3) The width of the gridding is 2.54mm.

CHARACTERISTIC CURVES

MAXIMUM SWITCHING POWER

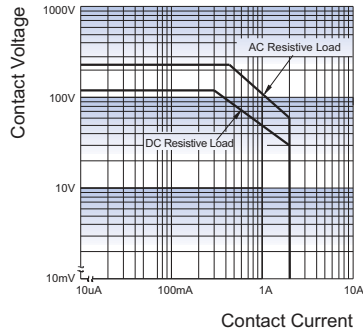

ENDURANCE CURVE

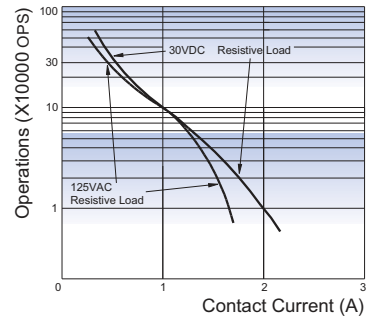

Test conditions:

Resistive load, at 85°C, 1s on 9s off.

Notice

- 1) To avoid using relays under strong magnetic field which will change the parameters of relays such as pick-up voltage and drop-out voltage.
- 2) The relay may be damaged because of falling or when shocking conditions exceed the requirement.
- 3) Contact is recommended for suitable condition and specifications if water cleaning or surface process is involved in assembling relays on PCB.
- 4) Regarding the plastic sealed relay, we should leave it cooling naturally until below 40°C after welding, then clean it and deal with coating, remarkably the temperature of solvents should also be controlled below 40°C. Please avoid cleaning the relay by ultrasonic, avoid using the solvents like gasoline, Freon, and so on, which would affect the configuration of relay or influence the environment.
- 5) Energizing coil with rated voltage is basic for normal operation of a relay, please make sure the energized voltage to relay coil have reached the rated voltage. Regarding latching relay, in order to maintain the "set" or "reset" status, impulse width of the rated voltage applied to coil should be more than 5 times of "set" or "reset" time.
- 6) About preferable condition of operation, storage and transportation, please refer to "Explanation to terminology and guidelines of relay".

Disclaimer

The specification is for reference only. See to "Terminology and Guidelines" for more information. Specifications subject to change without notice. We could not evaluate all the performance and all the parameters for every possible application. Thus the user should be in a right position to choose the suitable product for their own application. If there is any query, please contact Hongfa for the technical service. However, it is the user's responsibility to determine which product should be used only.

© Xiamen Hongfa Electroacoustic Co., Ltd. All rights of Hongfa are reserved.

HFD2

SUBMINIATURE DIP RELAY



File No.:E133481



File No.:CQC13002095174(Single side stable)
CQC13002095175(Latching)



Features

- High sensitive: 150mW
- Matching standard 16 pin IC socket
- High switching capacity: 125VA / 90W
- Bifurcated contacts
- Epoxy sealed for automatic wave soldering and cleaning
- Single side stable and latching type available
- Environmental friendly product (RoHS compliant)
- Outline Dimensions: (20.2 x 10.2 x 10.6) mm

CONTACT DATA

Contact arrangement	2C
Contact resistance	100mΩ max. (at 10mA 30mVDC)
Contact material	see ordering info.
Contact rating (Res. load)	1A 125VAC, 2A 30VDC 3A 30VDC
Max. switching voltage	250VAC / 220VDC
Max. switching current	3A
Max. switching power	125VA / 90W
Min. applicable load ¹⁾	10mV 10μA
Mechanical endurance	1 x 10 ⁸ OPS
Electrical endurance ²⁾	5 x 10 ⁴ OPS (2A 30VDC, Ag contact, Resistive load, at 70°C, 1s on 9s off)

Notes: 1) Min. applicable load is reference value. Please perform the confirmation test with the actual load before production since reference value may change according to switching frequencies, environmental conditions and expected contact resistance and reliability.

2) Electric endurance data are collected in one pair CO contact test.

COIL

Coil power		Sensitive	Standard
	Single side stable	Approx. 150mW	Approx. 200mW
1 coil latching	Approx. 75mW	Approx. 100mW	
2 coils latching	Approx. 150mW	Approx. 200mW	
Temperature rise	65K max.		

SAFETY APPROVAL RATINGS

UL/CUL	AgPd/ AgPd+Gold plated	0.5A 60VDC
		2A 30VDC
	Ag+Gold plated/ Ag+Gold plated	1A 120VAC
		2A 125VAC
		3A 30VDC
		2A 30VDC(at 70°C)

Notes: 1) All values unspecified are at room temperature.

2) Only typical loads are listed above. Other load specifications can be available upon request.

CHARACTERISTICS

Insulation resistance		1000MΩ (at 500VDC)
Dielectric strength	Between coil & contacts	1 coil: 1500VAC 1min 2 coils: 1000VAC 1min
	Between open contacts	1000VAC 1min
Operate time (at nomi. volt.)		4.5ms max.
Release time (at nomi. volt.)		3.5ms max.
Set time (latching)		4.5ms max.
Reset time (latching)		4.5ms max.
Ambient temperature		-40 °C to 85 °C
Humidity		5% to 85% RH
Vibration resistance		10Hz to 55Hz 1.5mm DA
Shock resistance	Functional	490m/s ²
	Destructive	980m/s ²
Termination		PCB (DIP)
Unit weight		Approx. 4.5g
Construction		Plastic sealed

Notes: 1) The data shown above are initial values.

2) UL insulation system: Class A

COIL DATA

at 23°C

Single side stable Standard type

Coil Code	Nominal Voltage VDC	Pick-up Voltage VDC max.	Drop-out Voltage VDC min.	Coil Resistance x(1±10%) Ω	Max. Voltage VDC
003-M	3	2.30	0.3	45	6
005-M	5	3.75	0.5	125	10
006-M	6	4.50	0.6	180	12
009-M	9	6.75	0.9	405	18
012-M	12	9.00	1.2	720	24
015-M	15	11.25	1.5	1125	30
024-M	24	18.0	2.4	2880	48
048-M	48	36.0	4.8	11520	96



HONGFA RELAY

ISO9001, ISO/TS16949, ISO14001, OHSAS18001, IECQ QC 080000 CERTIFIED

COIL DATA

at 23°C

Single side stable Sensitive type

Coil Code	Nominal Voltage VDC	Pick-up Voltage VDC max.	Drop-out Voltage VDC min.	Coil Resistance x(1±10%) Ω	Max. Voltage VDC
005-S	5	4.0	0.5	167	11.5
006-S	6	4.8	0.6	240	13.8
009-S	9	7.2	0.9	540	20.8
012-S	12	9.6	1.2	960	27.7
015-S	15	12.0	1.5	1500	34.6
024-S	24	19.2	2.4	3840	55.4

1 coil latching Standard type

Coil Code	Nominal Voltage VDC	Set / Reset Voltage VDC max.	Coil Resistance x(1±10%) Ω	Max. Voltage VDC
003-M-L1	3	2.25	90	8.4
005-M-L1	5	3.75	250	14
006-M-L1	6	4.5	360	17
009-M-L1	9	6.75	810	25
012-M-L1	12	9.0	1440	34
015-M-L1	15	11.25	2220	42
024-M-L1	24	18.0	4000	56

2 coils latching Standard type

Coil Code	Nominal Voltage VDC	Set / Reset Voltage VDC max.	Coil Resistance x(1±10%) Ω	Max. Voltage VDC
003-M-L2	3	2.25	45	6
005-M-L2	5	3.75	125	10
006-M-L2	6	4.5	180	12
009-M-L2	9	6.75	405	18
012-M-L2	12	9.0	720	24
015-M-L2	15	11.25	1125	30
024-M-L2	24	18.0	2040	48

1 coil latching Sensitive type

Coil Code	Nominal Voltage VDC	Set / Reset Voltage VDC max.	Coil Resistance x(1±10%) Ω	Max. Voltage VDC
003-S-L1	3	2.4	60	6.9
005-S-L1	5	4.0	330	16
006-S-L1	6	4.8	480	19
009-S-L1	9	7.2	1080	29
012-S-L1	12	9.6	1920	39
015-S-L1	15	12.0	3000	43
024-S-L1	24	19.2	7680	78

2 coils latching Sensitive type

Coil Code	Nominal Voltage VDC	Set / Reset Voltage VDC max.	Coil Resistance x(1±10%) Ω	Max. Voltage VDC
003-S-L2	3	2.4	60	6.9
005-S-L2	5	4.0	167	11.5
006-S-L2	6	4.8	240	13.8
009-S-L2	9	7.2	540	20.8
012-S-L2	12	9.6	960	27.7
015-S-L2	15	12.0	1500	34.6
024-S-L2	24	19.2	3840	55.4

Notes: 1) When user's requirements can't be found in the above table, special order allowed.

2) In case 5V of transistor drive circuit, it is recommended to use 4.5V type relay, and 3V to use 2.4V type relay.

TYPICAL CONTACT LIFE EXPECTANCY

Voltage	Power	Electrical endurance	
		Resistive Load	Inductive Load (For AC cosφ=0.7)
50mVDC	50μW	5 x 10 ⁷ OPS	5 x 10 ⁷ OPS
30VDC	20W	3 x 10 ⁶ OPS	1 x 10 ⁶ OPS
30VDC	30W	1 x 10 ⁶ OPS	3 x 10 ⁵ OPS
30VDC	60W	1 x 10 ⁵ OPS	1.5 x 10 ⁴ OPS
60VDC	20W	3 x 10 ⁶ OPS	--
60VDC	30W	5 x 10 ⁵ OPS	--
60VDC	60W	1 x 10 ⁵ OPS	--
30VAC	40VA	3 x 10 ⁶ OPS	1 x 10 ⁶ OPS
30VAC	80VA	1 x 10 ⁶ OPS	3 x 10 ⁵ OPS
30VAC	120VA	1 x 10 ⁵ OPS	1.5 x 10 ⁴ OPS
60VAC	40VA	3 x 10 ⁶ OPS	1 x 10 ⁶ OPS
60VAC	80VA	1 x 10 ⁶ OPS	3 x 10 ⁵ OPS
60VAC	120VA	1 x 10 ⁵ OPS	1.5 x 10 ⁴ OPS
125VAC	40VA	3 x 10 ⁶ OPS	1 x 10 ⁶ OPS
125VAC	80VA	1 x 10 ⁶ OPS	3 x 10 ⁵ OPS
125VAC	125VA	1 x 10 ⁵ OPS	1.5 x 10 ⁴ OPS

ORDERING INFORMATION

Type	HFD2 / 012 -S -L2 -A (XXX)			
Coil voltage	3, 5, 6, 9, 12, 15, 24, 48VDC ¹⁾			
Coil power	M: Standard S: Sensitive			
Sort	L1: 1 coil latching L2: 2 coils latching Nil: Single side stable			
Contact material	A: AgPd/AgPd+Gold plated D: Ag+Gold plated/Ag+Gold plated Nil: AgPd/Ag+Gold plated ²⁾			
Special code ³⁾	XXX: Customer special requirement		Nil: Standard	

Notes: 1) 48VDC coil voltage is only for single side stable & standard type.

2) Not for new design.

3) The customer special requirement express as special code after evaluating by Hongfa.

OUTLINE DIMENSIONS, WIRING DIAGRAM AND PC BOARD LAYOUT

Unit: mm

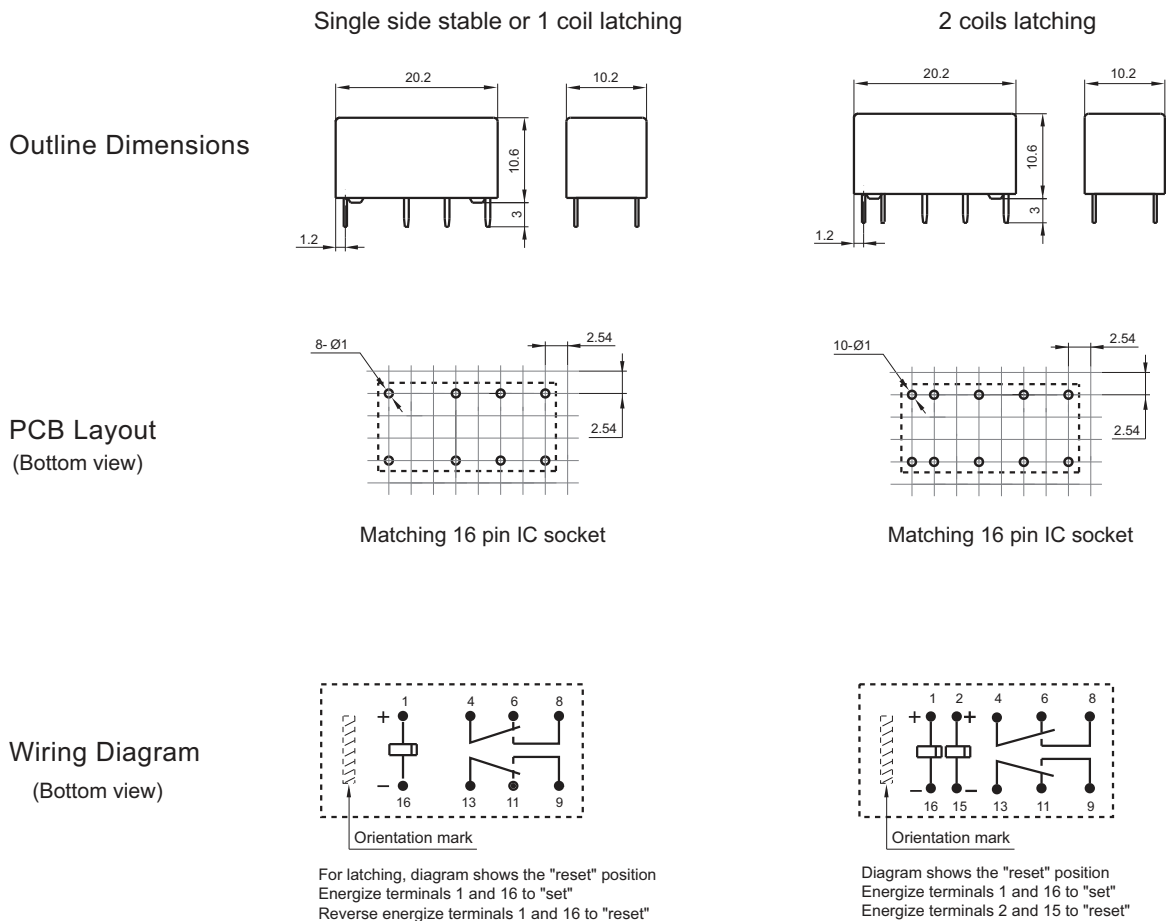

Remark: 1) In case of no tolerance shown in outline dimension: outline dimension ≤ 1 mm, tolerance should be ± 0.2 mm; outline dimension > 1 mm and ≤ 5 mm, tolerance should be ± 0.3 mm; outline dimension > 5 mm, tolerance should be ± 0.4 mm.

2) The tolerance without indicating for PCB layout is always ± 0.1 mm.

3) The width of the gridding is 2.54mm.

CHARACTERISTIC CURVES

MAXIMUM SWITCHING POWER

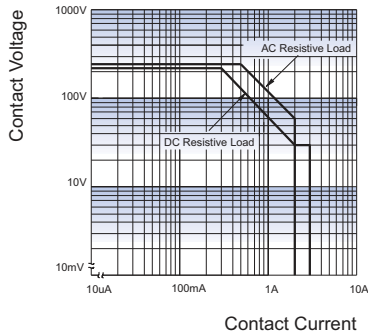

Test conditions:

Resistive load, at 70°C, 1s on 9s off.

COIL TEMPERATURE RISE

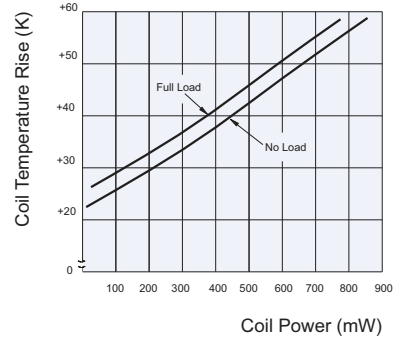

Notice

- 1) This relay is highly sensitive polarized relay, if correct polarity is not applied to the coil terminals, the relay does not operate properly.
- 2) To avoid using relays under strong magnetic field which will change the parameters of relays such as pick-up voltage and drop-out voltage.
- 3) Relay is on the "reset" status when being released from stock, with the consideration of shock risen from transit and relay mounting, it should be changed to the "set" status when application(connecting to the power supply). Please reset the relay to "set" or "reset" status on request.
- 4) Energizing coil with rated voltage is basic for normal operation of a relay, please make sure the energized voltage to relay coil have reached the rated voltage. Regarding latching relay, in order to maintain the "set" or "reset" status, impulse width of the rated voltage applied to coil should be more than 5 times of "set" or "reset" time.
- 5) For 2 coil latching relay, do not energize voltage to "set" coil and "reset" coil simultaneously.
- 6) The relay may be damaged because of falling or when shocking conditions exceed the requirement.
- 7) Contact is recommended for suitable condition and specifications if water cleaning or surface process is involved in assembling relays on PCB.
- 8) Regarding the plastic sealed relay, we should leave it cooling naturally until below 40°C after welding, then clean it and deal with coating, remarkably the temperature of solvents should also be controlled below 40°C. Please avoid cleaning the relay by ultrasonic, avoid using the solvents like gasoline, Freon, and so on, which would affect the configuration of relay or influence the environment.
- 9) About preferable condition of operation, storage and transportation, please refer to "Explanation to terminology and guidelines of relay".

Disclaimer

The specification is for reference only. See to "Terminology and Guidelines" for more information. Specifications subject to change without notice. We could not evaluate all the performance and all the parameters for every possible application. Thus the user should be in a right position to choose the suitable product for their own application. If there is any query, please contact Hongfa for the technical service. However, it is the user's responsibility to determine which product should be used only.

© Xiamen Hongfa Electroacoustic Co., Ltd. All rights of Hongfa are reserved.

HFD3

SUBMINIATURE SIGNAL RELAY



File No.:E133481



File No.:40018867



File No.:CQC1400207409

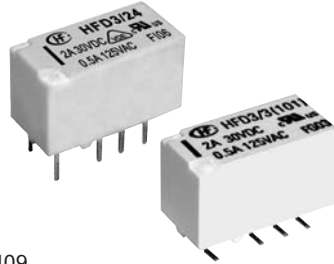

Features

- Surge withstand voltage up to 2500VAC, meets FCC Part 68 and Telecordia
- Meets EN60950 / EN41003
- SMT and DIP types available
- Bifurcated contacts
- Single side stable and latching type available
- Environmental friendly product (RoHS compliant)
- Outline Dimensions: (15.0 x 7.5 x 9.0) mm

CONTACT DATA

Contact arrangement	2C
Contact resistance	100mΩ max.(at 10mA 30mVDC)
Contact material	AgPd + Au plated, AgNi + Au plated
Contact rating (Res. load)	2A 30VDC 0.5A 125VAC
Max. switching current	4A
Max. switching voltage	277VAC / 220VDC
Max. switching power	62.5VA / 60W
Min. applicable load ¹⁾	10mV 10μA
Mechanical endurance	1 x 10 ⁸ OPS
Electrical endurance ²⁾	1 x 10 ⁵ OPS (0.5A 125VAC, Resistive load, AgNi + Au plated, at 85°C, 1s on 9s off)

Notes: 1) Min. applicable load is reference value. Please perform the confirmation test with the actual load before production since reference value may change according to switching frequencies, environmental conditions and expected contact resistance and reliability.

2) Electric endurance data are collected in one pair CO contact test.

CHARACTERISTICS

Insulation resistance	1000MΩ (at 500VDC)	
Dielectric strength	Between coil & contacts	2000VAC 1min ¹⁾
	Between open contacts	1000VAC 1min
	Between contact sets	1500VAC 1min
Surge withstand voltage		
Between open contacts (10/160μs)	1500VAC (FCC part 68)	
Between coil & contacts (2/10μs)	2500VAC (Telecordia)	
Operate time (Set time)	4ms max.	
Release time (Reset time)	4ms max.	
Ambient temperature	-40°C to 85°C	
Humidity	5% to 85% RH	
Vibration resistance	10Hz to 55Hz 3.3mm DA	
Shock resistance	Functional	735m/s ²
	Destructive	980m/s ²
Termination	DIP, SMT	
Unit weight	Approx. 2g	
Moisture sensitivity levels (Only for SMT type, JEDEC-STD-020)	MSL-3	
Construction	Plastic sealed	

Notes: 1) The data shown above are initial values.

2) UL insulation system: Class A

SAFETY APPROVAL RATINGS

UL/CUL	AgNi + Au plated	2A 30VDC at 85°C 0.5A 125VAC at 85°C
	AgPd + Au plated	0.5A 125VAC at 70°C
VDE	AgNi + Au plated	2A 30VDC at 85°C 0.5A 125VAC at 85°C

Notes: 1) All values unspecified are at room temperature.

2) Only typical loads are listed above. Other load specifications can be available upon request.

COIL

Coil power	Single side stable	Approx. 140mW
	1 coil latching	Approx. 100mW
	2 coils latching	Approx. 200mW
Temperature rise	50K max.	



HONGFA RELAY

ISO9001, ISO/TS16949, ISO14001, OHSAS18001, IECQ QC 080000 CERTIFIED

COIL DATA

at 23°C

Single side stable

Coil Code	Nominal Voltage VDC	Pick-up Voltage VDC max.	Drop-out Voltage VDC min.	Coil Resistance Ω	Nominal Power mW approx.	Max. Voltage VDC
HFD3/1.5	1.5	1.13	0.15	16 x (1±10%)	140	2.2
HFD3/2.4	2.4	1.8	0.24	41 x (1±10%)	140	3.6
HFD3/3	3	2.25	0.3	64.3 x (1±10%)	140	4.5
HFD3/4.5	4.5	3.38	0.45	145 x (1±10%)	140	6.7
HFD3/5	5	3.75	0.5	178 x (1±10%)	140	7.5
HFD3/6	6	4.5	0.6	257 x (1±10%)	140	9
HFD3/9	9	6.75	0.9	579 x (1±10%)	140	13.5
HFD3/12	12	9	1.2	1028 x (1±10%)	140	18
HFD3/24	24	18	2.4	4114 x (1±10%)	140	36
HFD3/48	48	36	4.8	8533 x (1±10%)	270	57.6

1 coil latching

Coil Code	Nominal Voltage VDC	Set Voltage VDC max.	Reset Voltage VDC max.	Coil Resistance Ω	Nominal Power mW approx.	Max. Voltage VDC
HFD3/1.5-L1	1.5	1.13	1.13	22.5 x (1±10%)	100	2.7
HFD3/2.4-L1	2.4	1.8	1.8	58 x (1±10%)	100	4.3
HFD3/3-L1	3	2.25	2.25	90 x (1±10%)	100	5.4
HFD3/4.5-L1	4.5	3.38	3.38	203 x (1±10%)	100	8.1
HFD3/5-L1	5	3.75	3.75	250 x (1±10%)	100	9
HFD3/6-L1	6	4.5	4.5	360 x (1±10%)	100	10.8
HFD3/9-L1	9	6.75	6.75	810 x (1±10%)	100	16.2
HFD3/12-L1	12	9	9	1440 x (1±10%)	100	21.6
HFD3/24-L1	24	18	18	5760 x (1±10%)	100	43.2

2 coils latching

Coil Code	Nominal Voltage VDC	Set Voltage VDC max.	Reset Voltage VDC max.	Coil Resistance Ω	Nominal Power mW approx.	Max. Voltage VDC
HFD3/1.5-L2	1.5	1.13	1.13	11.2 x (1±10%)	200	2.2
HFD3/2.4-L2	2.4	1.8	1.8	29 x (1±10%)	200	3.6
HFD3/3-L2	3	2.25	2.25	45 x (1±10%)	200	4.5
HFD3/4.5-L2	4.5	3.38	3.38	101 x (1±10%)	200	6.7
HFD3/5-L2	5	3.75	3.75	125 x (1±10%)	200	7.5
HFD3/6-L2	6	4.5	4.5	180 x (1±10%)	200	9.0
HFD3/9-L2	9	6.75	6.75	405 x (1±10%)	200	13.5
HFD3/12-L2	12	9	9	720 x (1±10%)	200	18
HFD3/24-L2	24	18	18	2880 x (1±10%)	200	36

Notes: 1) When user's requirements can't be found in the above table, special order allowed.

2) In case 5V of transistor drive circuit, it is recommended to use 4.5V type relay, and 3V to use 2.4V type relay

ORDERING INFORMATION

	HFD3 /		24	-L2	4	S	R	(XXX)
Type								
Coil voltage	1.5, 2.4, 3, 4.5, 5, 6, 9, 12, 24, 48VDC ¹⁾							
Sort	L1: 1 coil latching		Nil: Single side stable					
	L2: 2 coils latching							
Contact material	4: AgPd+Gold plated		Nil: AgNi+Gold plated					
Terminal type	S: Standard SMT		S1: Short terminal SMT		Nil: DIP			
Packing style	R: Tape and reel packing (Only for SMT type) ²⁾							
	Nil: Tube packing(Only for DIP type)							
Special code³⁾	XXX: Customer special requirement			Nil: Standard				

Notes: 1) 48VDC coil voltage is only for single side stable version.

2) R type (tape and reel) packing is moisture-proof which meets requirement of MSL-3. Please choose R type packing for SMT products. For R type, the letter "R" will only be printed on packing tag but not on relay cover. Tube packing is normally not available for SMT products unless specially requested by customer. But please note that tube packing is not moisture-proof so please bake the products before use according to description of Notice 11 herewith. In addition, tube packaging will be adopted when the ordering quantity of R type is equal to or less than 100 pieces unless otherwise specified.

3) The customer special requirement express as special code after evaluating by Hongfa. e.g.(131): The Dielectric strength between coil & contacts is 3000VAC 1min for single side stable and 1 coil latching version.

OUTLINE DIMENSIONS, WIRING DIAGRAM AND PC BOARD LAYOUT

Unit: mm

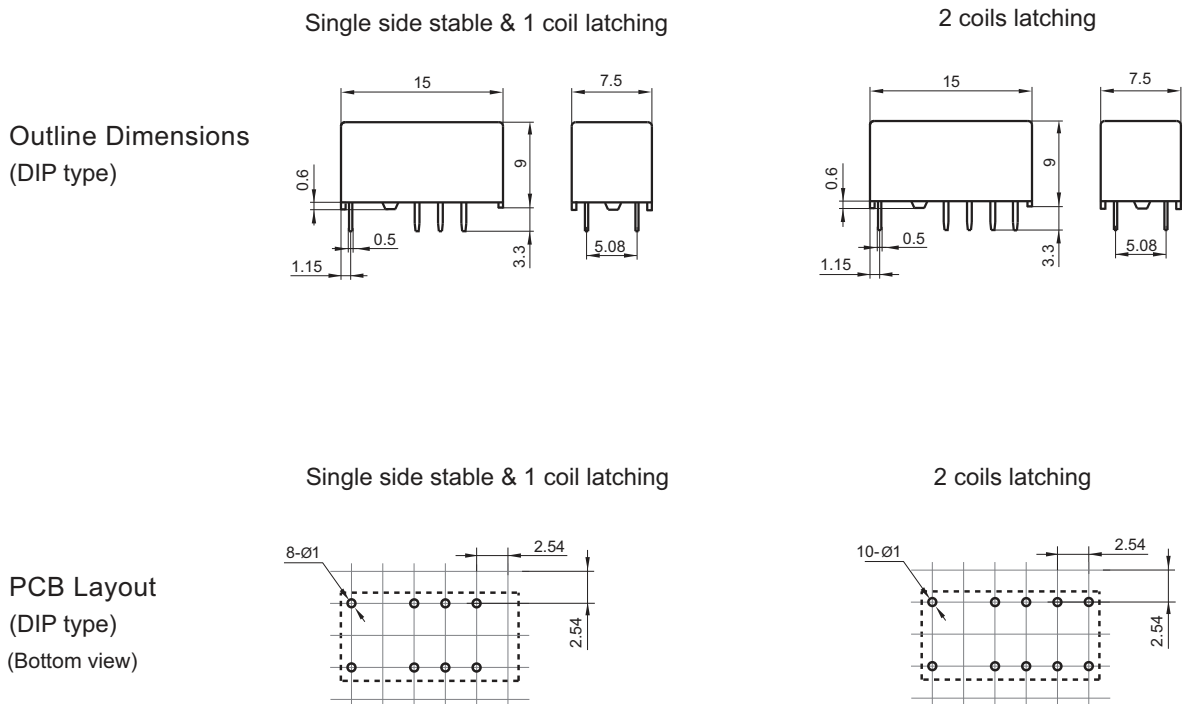

OUTLINE DIMENSIONS, WIRING DIAGRAM AND PC BOARD LAYOUT

Unit: mm

Outline Dimensions
(S type: Standard SMT)

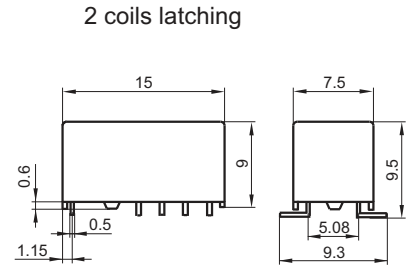
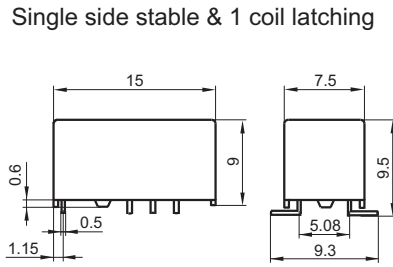

PCB Layout
(S type: Standard SMT)
(Bottom view)

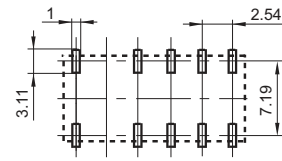
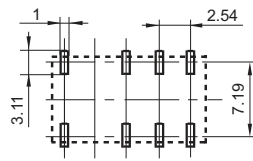

Outline Dimensions
(S1 type: Short terminal SMT)

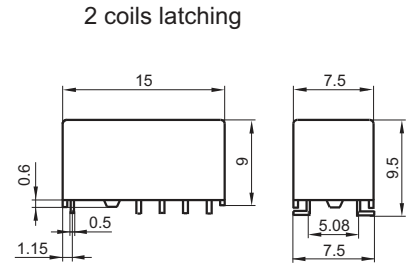
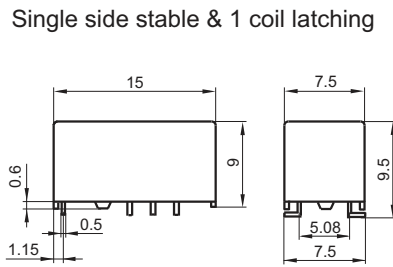

PCB Layout
(S1 type: Short terminal SMT)
(Bottom view)

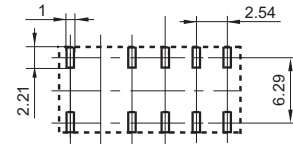
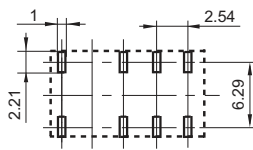

Wiring Diagram
(Bottom view)

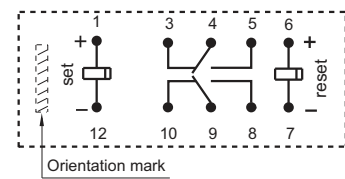
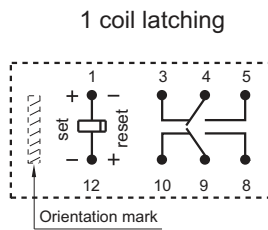
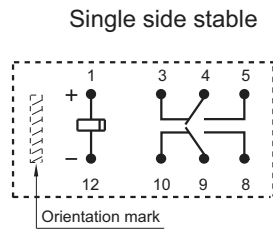

No energized condition

Reset condition

Reset condition

Direction of Relay Insertion

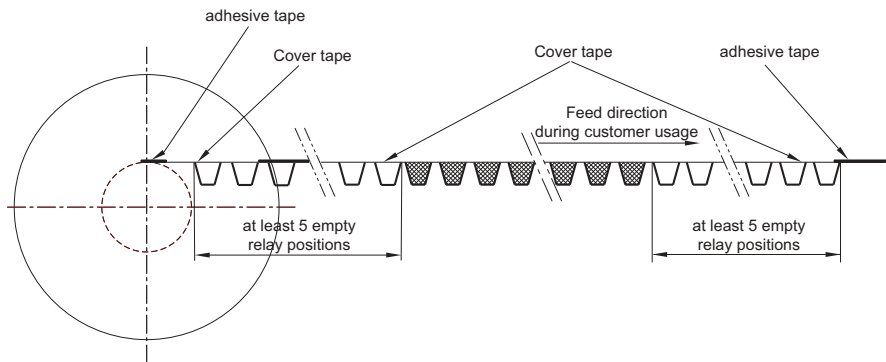
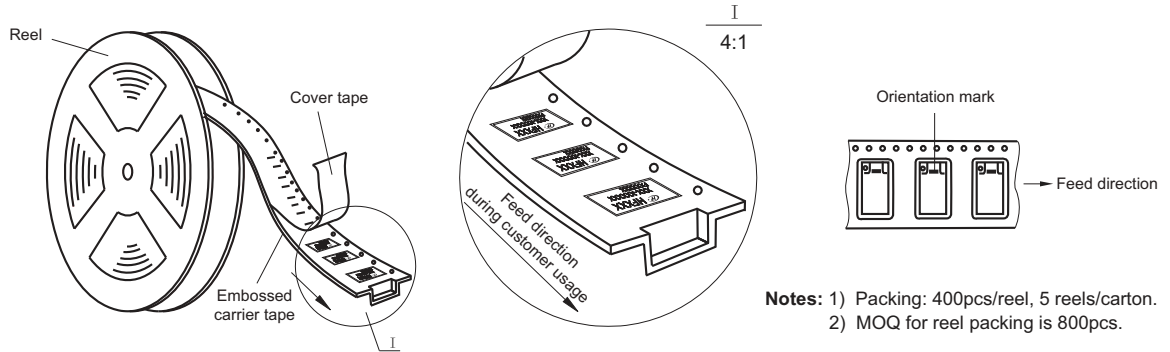

Reel Dimensions

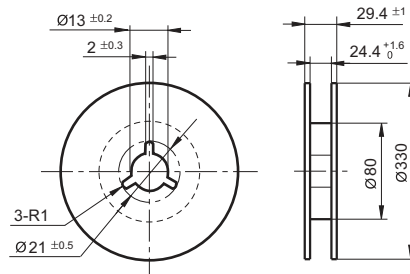

Tape Dimensions (S type: Standard SMT)

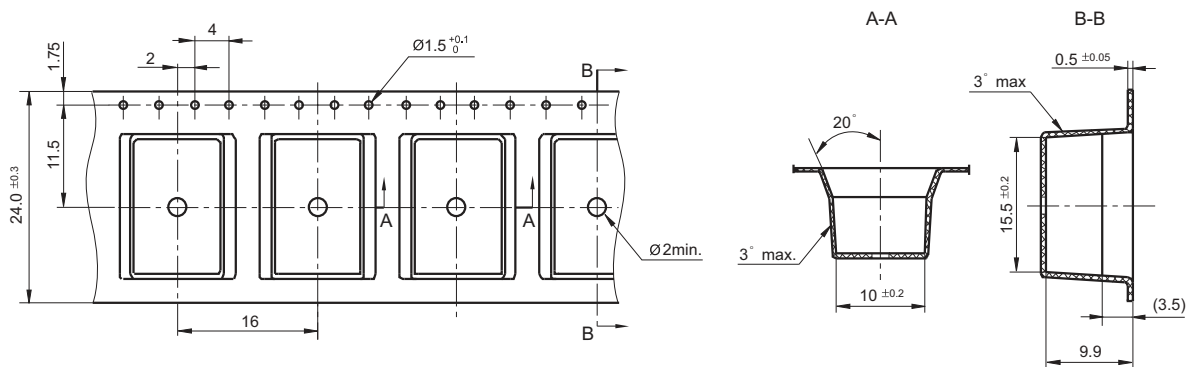

TAPE PACKING

Unit: mm

Tape Dimensions (S1 type: Short terminal SMT)

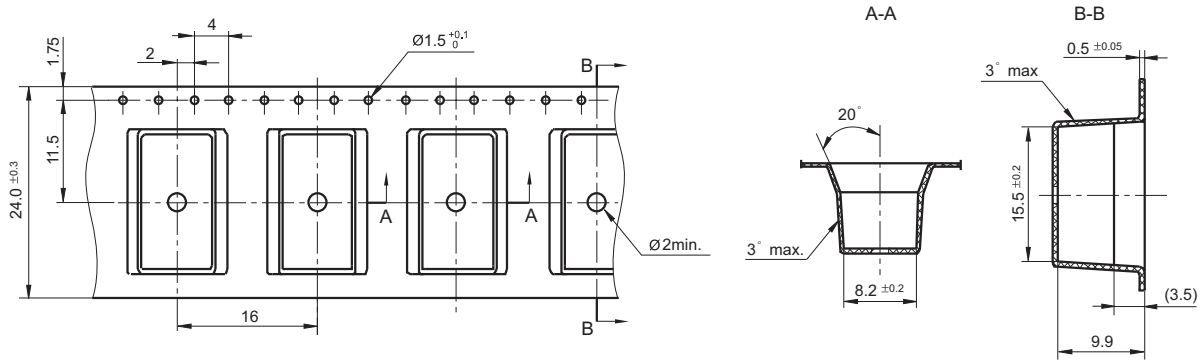

- Remark: 1) In case of no tolerance shown in outline dimension: outline dimension ≤ 1 mm, tolerance should be ± 0.2 mm; outline dimension > 1 mm and ≤ 5 mm, tolerance should be ± 0.3 mm; outline dimension > 5 mm, tolerance should be ± 0.4 mm.
 2) The tolerance without indicating for PCB layout is always ± 0.1 mm.
 3) The width of the gridding is 2.54mm.

CHARACTERISTIC CURVES

MAXIMUM SWITCHING POWER

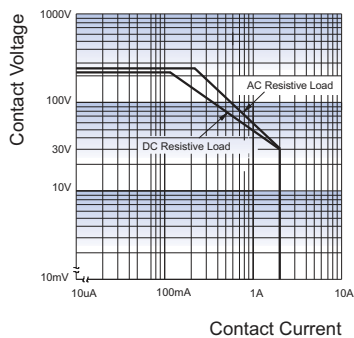

ENDURANCE CURVE

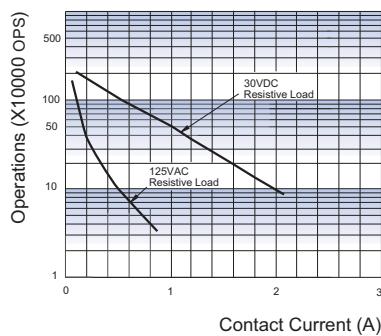

Test conditions:

Resistive load, at 85°C, 1s on 9s off.

REFLOW WELDING, TEMPERATURE ON PCB BOARD

RECOMMENDED WELDING TEMPERATURE



Notice

- 1) This relay is highly sensitive polarized relay, if correct polarity is not applied to the coil terminals, the relay does not operate properly.
- 2) To avoid using relays under strong magnetic field which will change the parameters of relays such as pick-up voltage and drop-out voltage.
- 3) Relay is on the "reset" status when being released from stock, with the consideration of shock risen from transit and relay mounting, it should be changed to the "set" status when application(connecting to the power supply). Please reset the relay to "set" or "reset" status on request.
- 4) Energizing coil with rated voltage is basic for normal operation of a relay, please make sure the energized voltage to relay coil have reached the rated voltage. Regarding latching relay, in order to maintain the "set" or "reset" status, impulse width of the rated voltage applied to coil should be more than 5 times of "set" or "reset" time.
- 5) For 2 coil latching relay, do not energize voltage to "set" coil and "reset" coil simultaneously.
- 6) The relay may be damaged because of falling or when shocking conditions exceed the requirement.
- 7) For SMT products, validation with real application should be done before your series production, if the reflow-soldering temperature curve is out of our recommendation. Generally, two-time reflow-soldering is not recommended for the relay. However, if two-time reflow-soldering is required, a 60-min. interval should be guaranteed and a validation should be done before production.
- 8) Contact is recommended for suitable condition and specifications if water cleaning or surface process is involved in assembling relays on PCB.
- 9) Regarding the plastic sealed relay, we should leave it cooling naturally until below 40°C after welding, then clean it and deal with coating, remarkably the temperature of solvents should also be controlled below 40°C. Please avoid cleaning the relay by ultrasonic, avoid using the solvents like gasoline, Freon, and so on, which would affect the configuration of relay or influence the environment.
- 10) About preferable condition of operation, storage and transportation, please refer to "Explanation to terminology and guidelines of relay".
- 11) Relays packaged in moisture barrier bags meet MSL-3 requirements. The relays should be stored at ambient conditions of $\leq 30^\circ\text{C}$ and $\leq 60\%$ RH after they are removed from their packaging, and should be used within 168 hours. If the relays cannot be used within 168 hours, please repack them or store them in a drying oven at $25^\circ\text{C} \pm 5^\circ\text{C}$, $\leq 10\%$ RH. Otherwise, relays may be subjected to a soldering test to check their performance, or they may be used after keeping them in an oven for 72 hours at with $50^\circ\text{C} \pm 5^\circ\text{C}$, $\leq 30\%$ RH.

Disclaimer

The specification is for reference only. See to "Terminology and Guidelines" for more information. Specifications subject to change without notice. We could not evaluate all the performance and all the parameters for every possible application. Thus the user should be in a right position to choose the suitable product for their own application. If there is any query, please contact Hongfa for the technical service. However, it is the user's responsibility to determine which product should be used only.

© Xiamen Hongfa Electroacoustic Co., Ltd. All rights of Hongfa are reserved.

HFD3-V

SUBMINIATURE SIGNAL RELAY



File No.: E133481



File No.: 40018867



File No.: CQC14002107409

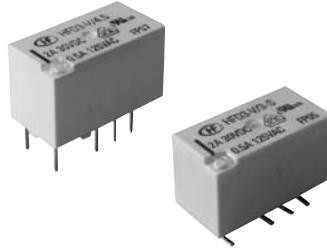

Features

- 3kV dielectric strength (between coil and contacts)
- Surge withstand voltage up to 6000VAC, meets FCC Part 68 and Telecordia
- Min. creepage is 2.5mm (between coil and contact), Min. clearance is 2.0mm (between coil and contact)
- Meets EN60950 / EN41003
- SMT and DIP types available
- Bifurcated contacts
- Single side stable and latching types available
- Environmental friendly product (RoHS compliant)
- Outline Dimensions: (15.0 x 7.5 x 9.4) mm

CONTACT DATA

Contact arrangement	2C
Contact resistance	100mΩ max. (at 10mA 30mVDC)
Contact material	AgPd + Au plated, AgNi + Au plated
Contact rating (Res. load)	2A 30VDC 0.5A 125VAC
Max. switching current	4A
Max. switching voltage	277VAC / 220VDC
Max. switching power	62.5VA / 60W
Min. applicable load	10mV 10μA ¹⁾
Mechanical endurance	1 x 10 ⁷ OPS
Electrical endurance ²⁾	1 x 10 ⁵ OPS (0.5A 125VAC, Resistive load, AgNi + Au plated, at 85°C, 1s on 9s off)

Notes: 1) Min. applicable load is reference value. Please perform the confirmation test with the actual load before production since reference value may change according to switching frequencies, environmental conditions and expected contact resistance and reliability.
2) Electric endurance data are collected in one pair CO contact test.

SAFETY APPROVAL RATINGS

UL/CUL	AgNi + Au plated	2A 30VDC at 85°C 0.5A 125VAC at 85°C
	AgPd + Au plated	0.5A 125VAC at 70°C
VDE	AgNi + Au plated	2A 30VDC at 85°C 0.5A 125VAC at 85°C

Notes: 1) All values unspecified are at room temperature.
2) Only typical loads are listed above. Other load specifications can be available upon request.

CHARACTERISTICS

Insulation resistance		1000MΩ (at 500VDC)
Dielectric strength	Between coil & contacts	3000VAC 1min
	Between open contacts	1500VAC 1min
	Between contact sets	1500VAC 1min
Surge withstand voltage		
Between open contacts(10/160μs)		2.5kV
Between coil & contacts(1.2/50μs)		6kV
Operate time (Set time)		6ms max.
Release time (Reset time)		6ms max.
Ambient temperature		-40°C to 85°C
Humidity		5% to 85% RH
Vibration resistance	Functional	10Hz to 55Hz 3.3mm DA
	Destructive	10Hz to 55Hz 5.0mm DA
Shock resistance	Functional	735m/s ²
	Destructive	980m/s ²
Termination		DIP, SMT
Unit weight		Approx. 2g
Moisture sensitivity levels (Only for SMT type, JEDEC-STD-020)		MSL-3
Construction		Plastic sealed

Notes: The data shown above are initial values.

COIL

Coil power	Single side stable	200mW
	1 coil latching	140mW
Temperature rise	50K max.	



HONGFA RELAY

ISO9001, ISO/TS16949, ISO14001, OHSAS18001, IECQ QC 080000 CERTIFIED

COIL DATA

at 23°C

Single side stable

Coil Code	Nominal Voltage VDC	Pick-up Voltage VDC max.	Drop-out Voltage VDC min.	Coil Resistance Ω	Nominal Power mW	Max. Voltage VDC
HFD3-V/1.5	1.5	1.13	0.15	11.2 x (1±10%)	200	2.2
HFD3-V/2.4	2.4	1.8	0.24	28.8 x (1±10%)	200	3.6
HFD3-V/3	3	2.25	0.3	45 x (1±10%)	200	4.5
HFD3-V/4.5	4.5	3.38	0.45	101 x (1±10%)	200	6.7
HFD3-V/5	5	3.75	0.5	125 x (1±10%)	200	7.5
HFD3-V/6	6	4.5	0.6	180 x (1±10%)	200	9
HFD3-V/9	9	6.75	0.9	405 x (1±10%)	200	13.5
HFD3-V/12	12	9	1.2	720 x (1±10%)	200	18
HFD3-V/24	24	18	2.4	2880 x (1±10%)	200	36

1 coil latching

Coil Code	Nominal Voltage VDC	Pick-up Voltage VDC max.	Drop-out Voltage VDC max.	Coil Resistance Ω	Nominal Power mW	Max. Voltage VDC
HFD3-V/1.5-L1	1.5	1.13	1.13	16.1 x (1±10%)	140	2.7
HFD3-V/2.4-L1	2.4	1.8	1.8	41 x (1±10%)	140	4.3
HFD3-V/3-L1	3	2.25	2.25	64.3 x (1±10%)	140	5.4
HFD3-V/4.5-L1	4.5	3.38	3.38	145 x (1±10%)	140	8.1
HFD3-V/5-L1	5	3.75	3.75	178 x (1±10%)	140	9
HFD3-V/6-L1	6	4.5	4.5	257 x (1±10%)	140	10.8
HFD3-V/9-L1	9	6.75	6.75	579 x (1±10%)	140	16.2
HFD3-V/12-L1	12	9	9	1028 x (1±10%)	140	21.6
HFD3-V/24-L1	24	18	18	4114 x (1±10%)	140	43.2

Notes: 1) In case 5V of transistor drive circuit, it is recommended to use 4.5V type relay, and 3V to use 2.4V type relay.

ORDERING INFORMATION

Type	HFD3-V / 24 -L1 4 S R (XXX)					
Coil voltage	1.5, 2.4, 3, 4.5, 5, 6, 9, 12, 24VDC					
Sort	L1: 1 coil latching		Nil: Single side stable			
Contact material	4: AgPd+Gold plated		Nil: AgNi+Gold plated			
Terminal type	S: Standard SMT		S1: Short terminal SMT		Nil: DIP	
Packing style	R: Tape and reel packing (Only for SMT type) ¹⁾ Nil: Tube packing(Only for DIP type)					
Special code ³⁾	XXX: Customer special requirement		Nil: Standard			

Notes: 1) R type (tape and reel) packing is moisture-proof which meets requirement of MSL-3. Please choose R type packing for SMT products. For R type, the letter "R" will only be printed on packing tag but not on relay cover. Tube packing is normally not available for SMT products unless specially requested by customer. But please note that tube packing is not moisture-proof so please bake the products before use according to description of Notice 11 herewith. In addition, tube packaging will be adopted when the ordering quantity of R type is equal to or less than 100 pieces unless otherwise specified.

2) The customer special requirement express as special code after evaluating by Hongfa. e.g.(131): The Dielectric strength between coil & contacts is 3000VAC 1min for single side stable and 1 coil latching version.

OUTLINE DIMENSIONS, WIRING DIAGRAM AND PC BOARD LAYOUT

Unit: mm

Outline Dimensions

PCB Layout (Bottom view)

DIP type

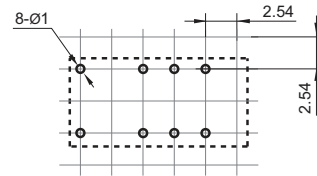
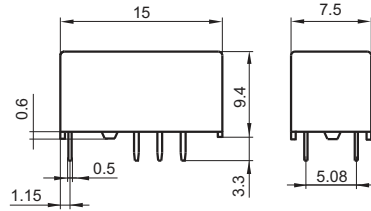

S type:
Standard SMT

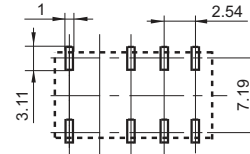
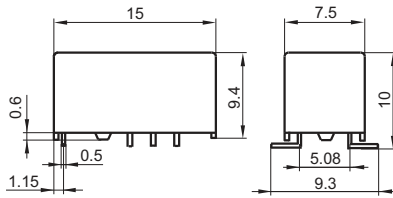

S1 type:
Short terminal SMT

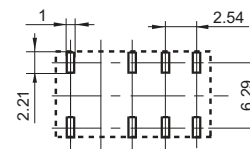
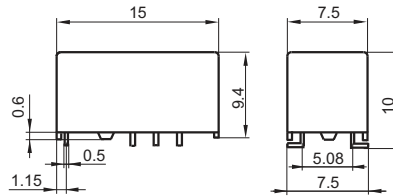

Wiring Diagram
(Bottom view)

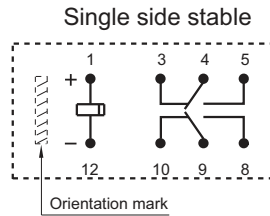

No energized condition

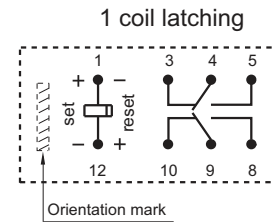

reset condition

Direction of Relay Insertion

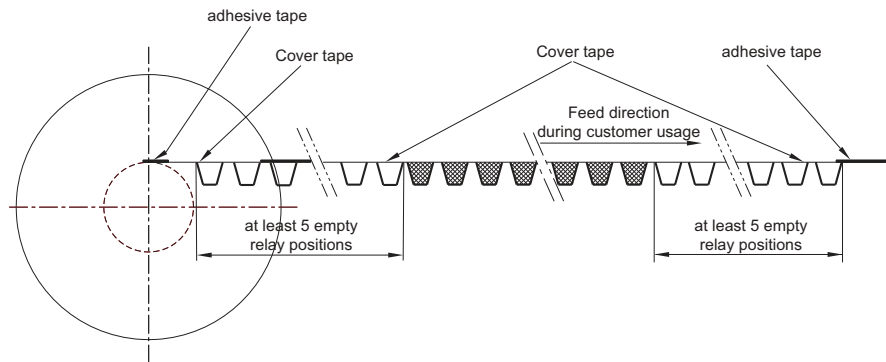
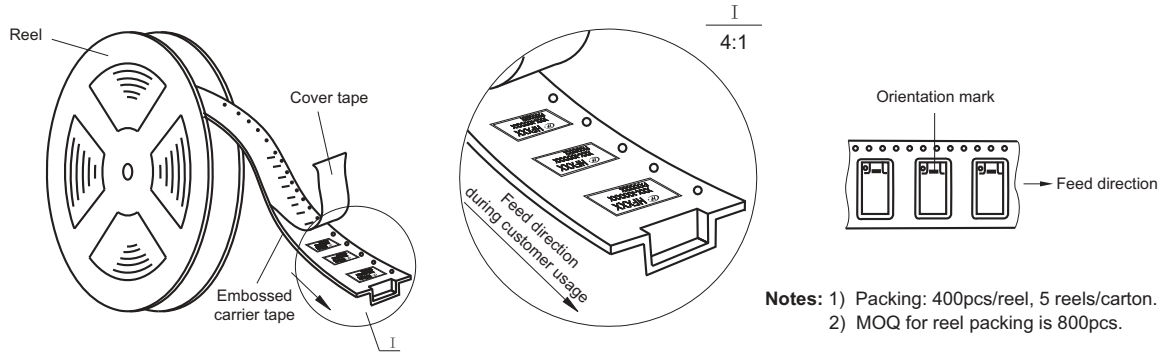

Reel Dimensions

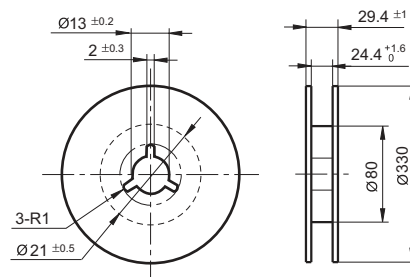

Tape Dimensions (S type: Standard SMT)

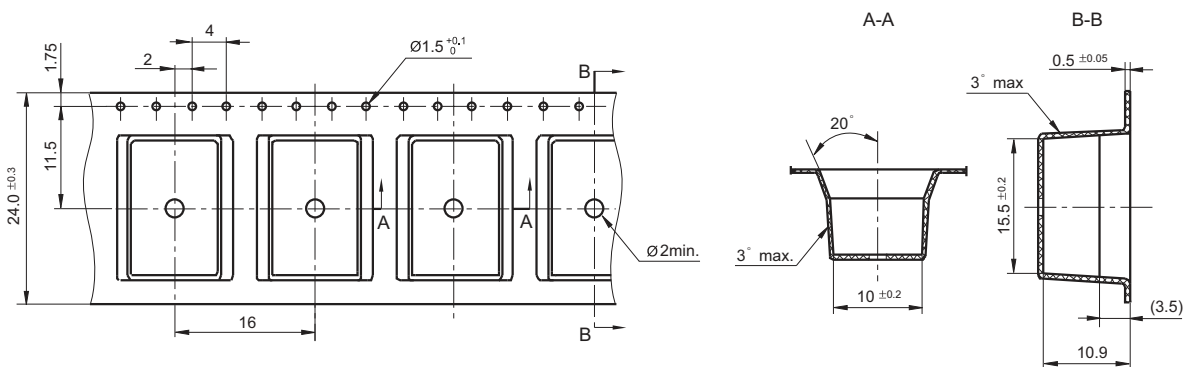

TAPE PACKING

Unit: mm

Tape Dimensions (S1 type: Short terminal SMT)

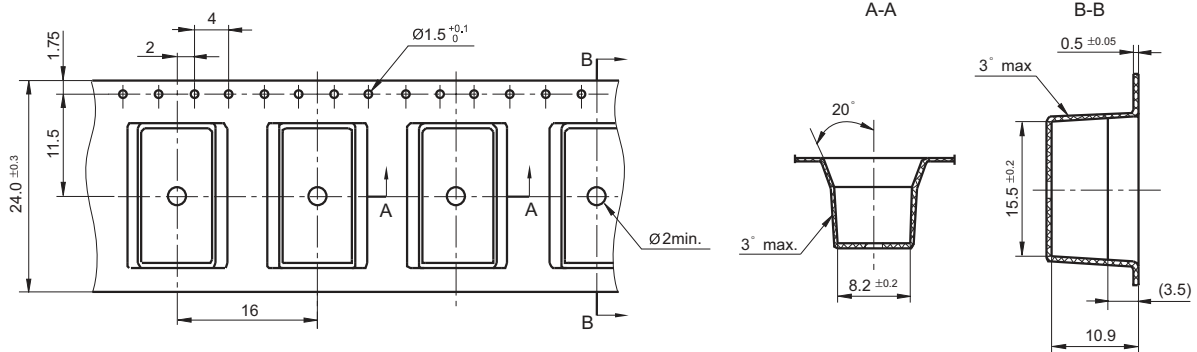

- Remark: 1) In case of no tolerance shown in outline dimension: outline dimension ≤ 1 mm, tolerance should be ± 0.2 mm; outline dimension > 1 mm and ≤ 5 mm, tolerance should be ± 0.3 mm; outline dimension > 5 mm, tolerance should be ± 0.4 mm.
 2) The tolerance without indicating for PCB layout is always ± 0.1 mm.
 3) The width of the gridding is 2.54mm.

CHARACTERISTIC CURVES

MAXIMUM SWITCHING POWER

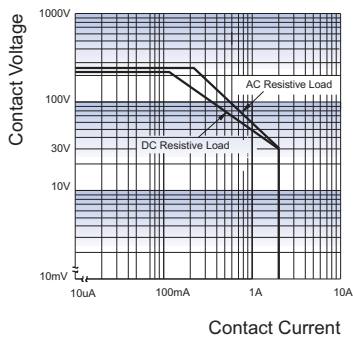

ENDURANCE CURVE

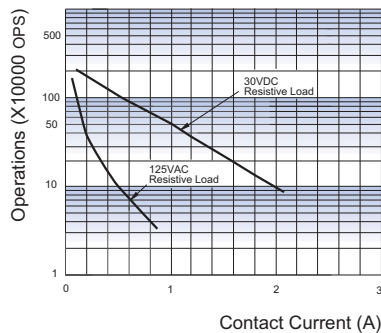

Test conditions:

Resistive load, at 85°C, 1s on 9s off.

REFLOW WELDING TEMPERATURE ON PCB BOARD

RECOMMENDED WELDING TEMPERATURE

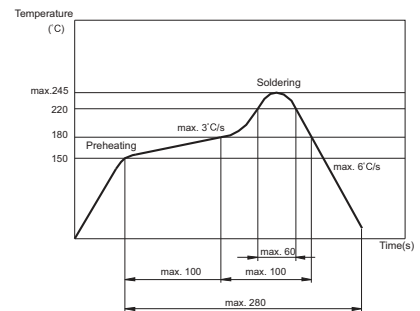

Notice

- 1) This relay is highly sensitive polarized relay, if correct polarity is not applied to the coil terminals, the relay does not operate properly.
- 2) To avoid using relays under strong magnetic field which will change the parameters of relays such as pick-up voltage and drop-out voltage.
- 3) Relay is on the "reset" status when being released from stock, with the consideration of shock risen from transit and relay mounting, it should be changed to the "set" status when application(connecting to the power supply). Please reset the relay to "set" or "reset" status on request.
- 4) Energizing coil with rated voltage is basic for normal operation of a relay, please make sure the energized voltage to relay coil have reached the rated voltage. Regarding latching relay, in order to maintain the "set" or "reset" status, impulse width of the rated voltage applied to coil should be more than 5 times of "set" or "reset" time.
- 5) The relay may be damaged because of falling or when shocking conditions exceed the requirement.
- 6) For SMT products, validation with real application should be done before your series production, if the reflow-soldering temperature curve is out of our recommendation. Generally, two-time reflow-soldering is not recommended for the relay. However, if two-time reflow-soldering is required, a 60-min. interval should be guaranteed and a validation should be done before production.
- 7) Contact is recommended for suitable condition and specifications if water cleaning or surface process is involved in assembling relays on PCB.
- 8) Regarding the plastic sealed relay, we should leave it cooling naturally until below 40°C after welding, then clean it and deal with coating, remarkably the temperature of solvents should also be controlled below 40°C. Please avoid cleaning the relay by ultrasonic, avoid using the solvents like gasoline, Freon, and so on, which would affect the configuration of relay or influence the environment.
- 9) About preferable condition of operation, storage and transportation, please refer to "Explanation to terminology and guidelines of relay".
- 10) Relays packaged in moisture barrier bags meet MSL-3 requirements. The relays should be stored at ambient conditions of $\leq 30^\circ\text{C}$ and $\leq 60\%$ RH after they are removed from their packaging, and should be used within 168 hours. If the relays cannot be used within 168 hours, please repack them or store them in a drying oven at $25^\circ\text{C} \pm 5^\circ\text{C}$, $\leq 10\%$ RH. Otherwise, relays may be subjected to a soldering test to check their performance, or they may be used after keeping them in an oven for 72 hours at with $50^\circ\text{C} \pm 5^\circ\text{C}$, $\leq 30\%$ RH.

Disclaimer

The specification is for reference only. See to "Terminology and Guidelines" for more information. Specifications subject to change without notice. We could not evaluate all the performance and all the parameters for every possible application. Thus the user should be in a right position to choose the suitable product for their own application. If there is any query, please contact Hongfa for the technical service. However, it is the user's responsibility to determine which product should be used only.

© Xiamen Hongfa Electroacoustic Co., Ltd. All rights of Hongfa are reserved.

HFD31

SUBMINIATURE SIGNAL RELAY

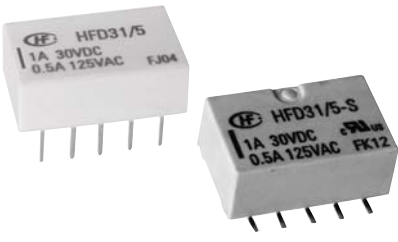

Features

- Offers excellent board space savings
- Surge withstand voltage up to 1500V, meets FCC Part 68
- High contact capacity 1A 30VDC
- Low power consumption
- Single side stable and latching type available
- Single or double coil winding type available
- Environmental friendly product (RoHS compliant)
- Outline Dimensions: (14.0 x 9.0 x 5.0) mm



File No.:E133481

CONTACT DATA

Contact arrangement	2C
Contact resistance	100mΩ max. (at 10mA 30mVDC)
Contact material	AgPd + Au plated, AgNi + Au plated
Contact rating (Res. load)	1A 30VDC 0.5A 125VAC
Max. switching current	2A
Max. switching voltage	125VAC/110VDC
Max. switching power	62.5VA / 30W
Min. applicable load ¹⁾	10mV 10μA
Mechanical endurance	1 x 10 ⁸ OPS
Electrical endurance ²⁾	1 x 10 ⁵ OPS (0.5A 125VAC, Resistive load, AgNi + Au plated, at 70°C, 1s on 9s off)

Notes: 1) Min. applicable load is reference value. Please perform the confirmation test with the actual load before production since reference value may change according to switching frequencies, environmental conditions and expected contact resistance and reliability.
2) Electrical endurance test is conducted with load being connected to NO or NC contacts.

COIL

Coil power	Single side stable	Approx. 140mW (24VDC: Approx. 200mW)
	1 coil latching	Approx. 100mW (24VDC: Approx. 150mW)
	2 coils latching	Approx. 200mW (24VDC: Approx. 300mW)

CHARACTERISTICS

Insulation resistance		1000MΩ (at 500VDC)
Dielectric strength	Between coil & contacts	1000VAC 1min
	Between open contacts	750VAC 1min
	Between contact sets	1000VAC 1min
Surge withstand voltage Between open contacts (10/160μs)		1500VAC (FCC part 68)
Operate time (Set time)		3ms max.
Release time (Reset time)		3ms max.
Ambient temperature		-40°C to 70°C
Humidity		5% to 85% RH
Vibration resistance		10Hz to 55Hz 3.0mm DA
Shock resistance	Functional	490m/s ²
	Destructive	980m/s ²
Termination		DIP, SMT
Unit weight		Approx. 1.8g
Moisture sensitivity levels (Only for SMT type, JEDEC-STD-020)		MSL-3
Construction		Plastic sealed

Notes: 1) The data shown above are initial values.
2) UL insulation system: Class A

SAFETY APPROVAL RATINGS

UL/CUL	AgNi + Au plated	1A 30VDC 2A 30VDC 0.5A 125VAC
	AgPd + Au plated	0.5A 125VAC

Notes: 1) All values unspecified are at room temperature.
2) Only typical loads are listed above. Other load specifications



HONGFA RELAY

ISO9001, ISO/TS16949, ISO14001, OHSAS18001, IECQ QC 080000 CERTIFIED

COIL DATA

at 23°C

Single side stable

Coil Code	Nominal Voltage VDC	Pick-up Voltage VDC max.	Drop-out Voltage VDC min.	Coil Resistance Ω	Nominal Power mW approx.	Max. Voltage VDC
HFD31/1.5	1.5	1.13	0.15	16 x (1±10%)	140	2.25
HFD31/2.4	2.4	1.8	0.24	41.3 x (1±10%)	140	3.6
HFD31/3	3	2.25	0.3	64.3 x (1±10%)	140	4.5
HFD31/4.5	4.5	3.38	0.45	145 x (1±10%)	140	6.7
HFD31/5	5	3.75	0.5	178 x (1±10%)	140	7.5
HFD31/6	6	4.5	0.6	257 x (1±10%)	140	9
HFD31/9	9	6.75	0.9	579 x (1±10%)	140	13.5
HFD31/12	12	9	1.2	1028 x (1±10%)	140	18
HFD31/24	24	18	2.4	2880 x (1±10%)	200	36

1 coil latching

Coil Code	Nominal Voltage VDC	Set Voltage VDC max.	Reset Voltage VDC max.	Coil Resistance Ω	Nominal Power mW approx.	Max. Voltage VDC
HFD31/1.5-L1	1.5	1.13	1.13	22.5 x (1±10%)	100	2.25
HFD31/2.4-L1	2.4	1.8	1.8	58 x (1±10%)	100	3.6
HFD31/3-L1	3	2.25	2.25	90 x (1±10%)	100	4.5
HFD31/4.5-L1	4.5	3.38	3.38	203 x (1±10%)	100	6.7
HFD31/5-L1	5	3.75	3.75	250 x (1±10%)	100	7.5
HFD31/6-L1	6	4.5	4.5	360 x (1±10%)	100	9
HFD31/9-L1	9	6.75	6.75	810 x (1±10%)	100	13.5
HFD31/12-L1	12	9	9	1440 x (1±10%)	100	18
HFD31/24-L1	24	18	18	3840 x (1±10%)	150	36

2 coils latching

Coil Code	Nominal Voltage VDC	Set Voltage VDC max.	Reset Voltage VDC max.	Coil Resistance Ω	Nominal Power mW approx.	Max. Voltage VDC
HFD31/1.5-L2	1.5	1.13	1.13	11.3 x (1±10%)	200	2.25
HFD31/2.4-L2	2.4	1.8	1.8	29 x (1±10%)	200	3.6
HFD31/3-L2	3	2.25	2.25	45 x (1±10%)	200	4.5
HFD31/4.5-L2	4.5	3.38	3.38	101 x (1±10%)	200	6.7
HFD31/5-L2	5	3.75	3.75	125 x (1±10%)	200	7.5
HFD31/6-L2	6	4.5	4.5	180 x (1±10%)	200	9.0
HFD31/9-L2	9	6.75	6.75	405 x (1±10%)	200	13.5
HFD31/12-L2	12	9	9	720 x (1±10%)	200	18
HFD31/24-L2	24	18	18	1920 x (1±10%)	300	36

Notes: 1) When user's requirements can't be found in the above table, special order allowed.

2) In case 5V of transistor drive circuit, it is recommended to use 4.5V type relay, and 3V to use 2.4V type relay.

ORDERING INFORMATION

	HFD31 /		24	-L1	4	S	R	(XXX)
Type								
Coil voltage	1.5, 2.4, 3, 4.5, 5, 6, 9, 12, 24VDC							
Sort	L1: 1 coil latching		L2: 2 coils latching					
	Nil: Single side stable							
Contact material	4: AgPd+Gold plated		Nil: AgNi+Gold plated					
Terminal type	S: Standard SMT		Nil: DIP					
Packing style	R: Tape and reel packing (Only for SMT type) ¹⁾							
	Nil: Tube packing(Only for DIP type)							
Special code²⁾	XXX: Customer special requirement		Nil: Standard					

Notes: 1) R type (tape and reel) packing is moisture-proof which meets requirement of MSL-3. Please choose R type packing for SMT products. For R type, the letter "R" will only be printed on packing tag but not on relay cover. Tube packing is normally not available for SMT products unless specially requested by customer. But please note that tube packing is not moisture-proof so please bake the products before use according to description of Notice 11 herewith. In addition, tube packaging will be adopted when the ordering quantity of R type is equal to or less than 100 pieces unless otherwise specified.

2) The customer special requirement express as special code after evaluating by Hongfa.

OUTLINE DIMENSIONS, WIRING DIAGRAM AND PC BOARD LAYOUT

Unit: mm

Outline Dimensions

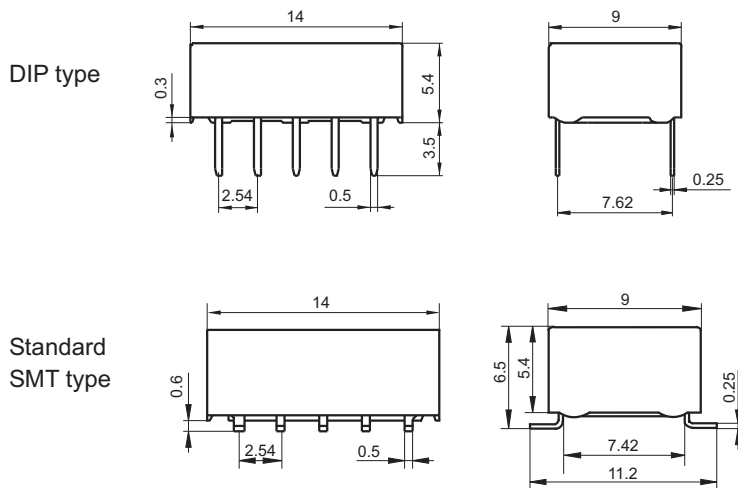

PCB Layout
(Bottom view)

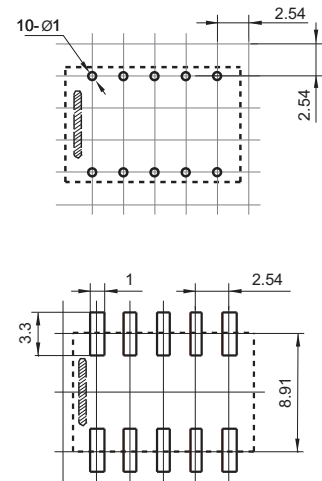

Remark: 1) In case of no tolerance shown in outline dimension: outline dimension ≤ 1 mm, tolerance should be ± 0.2 mm; outline dimension > 1 mm and ≤ 5 mm, tolerance should be ± 0.3 mm; outline dimension > 5 mm, tolerance should be ± 0.4 mm.

2) The tolerance without indicating for PCB layout is always ± 0.1 mm.

3) The width of the gridding is 2.54mm.

OUTLINE DIMENSIONS, WIRING DIAGRAM AND PC BOARD LAYOUT

Unit: mm

Wiring Diagram (Bottom view)

Single side stable

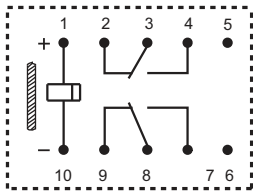

Deenergized condition

1 coil latching

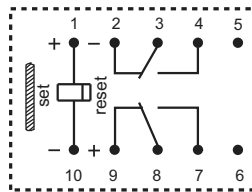

Reset condition

2 coils latching

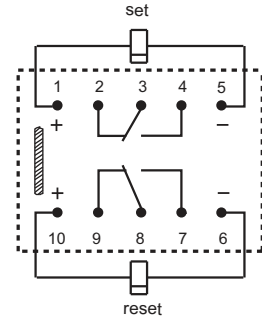

Reset condition

TAPE & REEL PACKING CONSTRUCTION AND DIMENSION

Unit: mm

Reel Dimensions

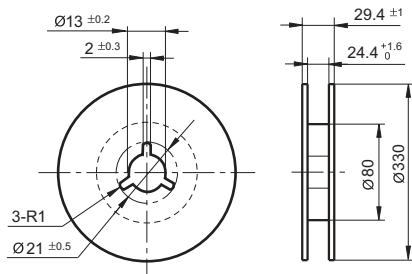

Direction of Relay Insertion

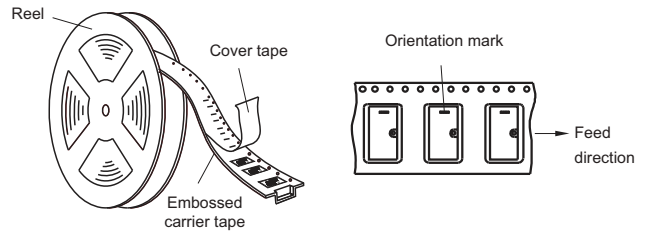

- Notes:** 1) Packing: 550pcs/reel, 4 reels/carton.
2) MOQ for reel packing is 550pcs.

Tape Dimensions

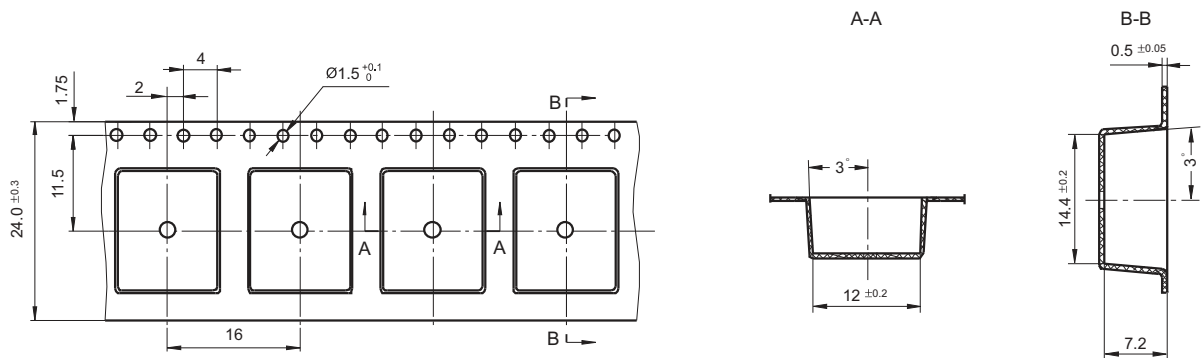

RECOMMENDED SOLDERING CONDITIONS

Temperature/Time profile of Reflow Soldering see below:

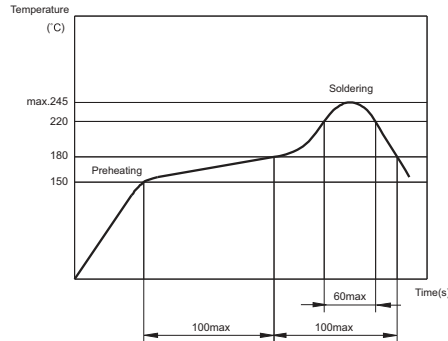

- Notes:** 1) Temperature profile shows Printed Circuit Board surface temperature on the relay terminal portion.
2) Please check the actual soldering condition to use other method except above mentioned temperature profiles.

CHARACTERISTIC CURVES

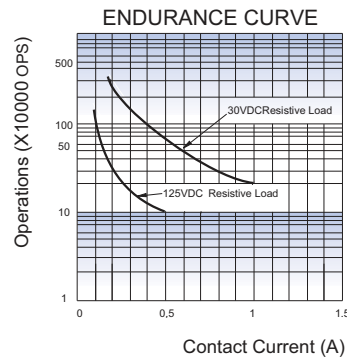
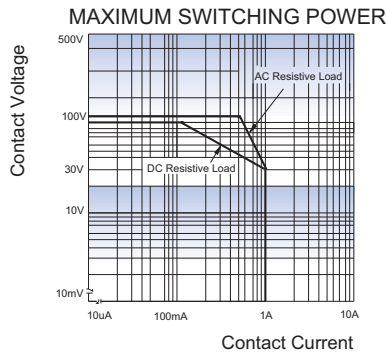

Test conditions:
Resistive load, at 40°C, 1s on 9s off.

Notice

- 1) This relay is highly sensitive polarized relay, if correct polarity is not applied to the coil terminals, the relay does not operate properly.
- 2) To avoid using relays under strong magnetic field which will change the parameters of relays such as pick-up voltage and drop-out voltage.
- 3) Relay is on the "reset" status when being released from stock, with the consideration of shock risen from transit and relay mounting, it should be changed to the "set" status when application(connecting to the power supply). Please reset the relay to "set" or "reset" status on request.
- 4) Energizing coil with rated voltage is basic for normal operation of a relay, please make sure the energized voltage to relay coil have reached the rated voltage. Regarding latching relay, in order to maintain the "set" or "reset" status, impulse width of the rated voltage applied to coil should be more than 5 times of "set" or "reset" time.
- 5) For 2 coil latching relay, do not energize voltage to "set" coil and "reset" coil simultaneously.
- 6) The relay may be damaged because of falling or when shocking conditions exceed the requirement.
- 7) For SMT products, validation with real application should be done before your series production, if the reflow-soldering temperature curve is out of our recommendation. Generally, two-time reflow-soldering is not recommended for the relay. However, if two-time reflow-soldering is required, a 60-min. interval should be guaranteed and a validation should be done before production.
- 8) Contact is recommended for suitable condition and specifications if water cleaning or surface process is involved in assembling relays on PCB.
- 9) Regarding the plastic sealed relay, we should leave it cooling naturally until below 40°C after welding, then clean it and deal with coating, remarkably the temperature of solvents should also be controlled below 40°C. Please avoid cleaning the relay by ultrasonic, avoid using the solvents like gasoline, Freon, and so on, which would affect the configuration of relay or influence the environment.
- 10) About preferable condition of operation, storage and transportation, please refer to "Explanation to terminology and guidelines of relay".
- 11) Relays packaged in moisture barrier bags meet MSL-3 requirements. The relays should be stored at ambient conditions of $\leq 30^{\circ}\text{C}$ and $\leq 60\%$ RH after they are removed from their packaging, and should be used within 168 hours. If the relays cannot be used within 168 hours, please repack them or store them in a drying oven at $25^{\circ}\text{C} \pm 5^{\circ}\text{C}$, $\leq 10\%$ RH. Otherwise, relays may be subjected to a soldering test to check their performance, or they may be used after keeping them in an oven for 72 hours at with $50^{\circ}\text{C} \pm 5^{\circ}\text{C}$, $\leq 30\%$ RH.

Disclaimer

The specification is for reference only. See to "Terminology and Guidelines" for more information. Specifications subject to change without notice. We could not evaluate all the performance and all the parameters for every possible application. Thus the user should be in a right position to choose the suitable product for their own application. If there is any query, please contact Hongfa for the technical service. However, it is the user's responsibility to determine which product should be used only.

© Xiamen Hongfa Electroacoustic Co., Ltd. All rights of Hongfa are reserved.

HFD4

SUBMINIATURE SIGNAL RELAY



File No.:E133481



File No.:R50333270



File No.:CQC16002154335(Single side stable)
CQC16002154336(Latching)

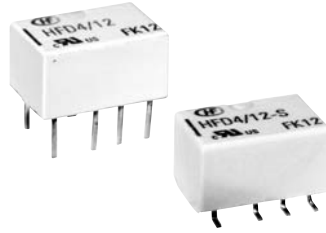

Features

- Offers excellent board space savings
- Surge withstand voltage up to 2500V, meets FCC Part 68 and Telecordia
- Meets EN60950/EN41003
- SMT and DIP types available
- High contact capacity 2A 30VDC
- Low power consumption
- Single side stable and latching type available
- Environmental friendly product (RoHS compliant)
- Outline Dimensions: (10.0 x 6.5 x 5.4) mm

CONTACT DATA

Contact arrangement	2C
Contact resistance	100mΩ max. (at 10mA 30mVDC)
Contact material	AgPd + Au plated, AgNi + Au plated
Contact rating (Res. load)	2A 30VDC 0.5A 125VAC
Max. switching current	2A
Max. switching voltage	250VAC / 220VDC
Max. switching power	62.5VA / 60W
Min. applicable load ¹⁾	10mV 10μA
Mechanical endurance	1 x 10 ⁶ OPS
Electrical endurance ²⁾	1 x 10 ⁵ OPS (AgNi + Au plated, 0.5A 125VAC, Resistive load, at 40°C, 1s on 9s off)

Notes: 1) Min. applicable load is reference value. Please perform the confirmation test with the actual load before production since reference value may change according to switching frequencies, environmental conditions and expected contact resistance and reliability.

2) Electric endurance data are collected in one pair CO contact test.

COIL

Coil power	Single side stable	See "COIL DATA"
	1 coil latching	See "COIL DATA"
Temperature rise	50K max.(At 1A load, 85°C environment)	

CHARACTERISTICS

Insulation resistance		1000MΩ (at 500VDC)
Dielectric strength	Between coil & contacts	1600VAC 1min
	Between open contacts	1000VAC 1min
	Between contact sets	1800VAC 1min
Surge withstand voltage		
Between open contacts (10/160μs)		1500VAC (FCC part 68)
Between coil & contacts (2/10μs)		2500VAC (Telecordia)
Operate time (Set time)		3ms max.
Release time (Reset time)		3ms max.
Ambient temperature		-40°C to 85°C
Humidity		5% to 85% RH
Vibration resistance		10Hz to 55Hz 3.3mm DA
Shock resistance	Functional	735m/s ²
	Destructive	980m/s ²
Termination		DIP, SMT
Unit weight		Approx. 0.8g
Moisture sensitivity levels (Only for SMT type, JEDEC-STD-020)		MSL 3
Construction		Plastic sealed

Notes: 1) The data shown above are initial values.

2) UL insulation system: Class A

SAFETY APPROVAL RATINGS

UL/CUL	AgPd + Au plated	0.5A 125VAC at 70°C
	AgNi + Au plated	1A 30VDC at 85°C 2A 30VDC at 40°C 0.5A 125VAC at 40°C
TUV	AgPd + Au plated	0.5A 125VAC at 85°C
	AgNi + Au plated	1A 30VDC at 85°C 0.5A 125VAC at 85°C

Notes: 1) All values unspecified are at room temperature.

2) Only typical loads are listed above. Other load specifications can be available upon request.



HONGFA RELAY

ISO9001, ISO/TS16949, ISO14001, OHSAS18001, IECQ QC 080000 CERTIFIED

COIL DATA

at 23°C

Single side stable

Coil Code	Nominal Voltage VDC	Pick-up Voltage VDC max.	Drop-out Voltage VDC min.	Coil Resistance Ω	Nominal Power mW approx.	Max. Voltage VDC
HFD4/1.5	1.5	1.13	0.15	16 x (1±10%)	140	2.2
HFD4/2.4	2.4	1.8	0.24	41 x (1±10%)	140	3.6
HFD4/3	3	2.25	0.3	64.3 x (1±10%)	140	4.5
HFD4/4.5	4.5	3.38	0.45	145 x (1±10%)	140	6.7
HFD4/5	5	3.75	0.5	178 x (1±10%)	140	7.5
HFD4/6	6	4.5	0.6	257 x (1±10%)	140	9.0
HFD4/9	9	6.75	0.9	579 x (1±10%)	140	13.5
HFD4/12	12	9	1.2	1028 x (1±10%)	140	18.0
HFD4/24	24	18	2.4	2880 x (1±10%)	200	36.0

1 coil latching

Coil Code	Nominal Voltage VDC	Set Voltage VDC max.	Reset Voltage VDC max.	Coil Resistance Ω	Nominal Power mW approx.	Max. Voltage VDC
HFD4/1.5-L	1.5	1.13	1.13	22.5 x (1±10%)	100	3.0
HFD4/2.4-L	2.4	1.8	1.8	58 x (1±10%)	100	4.8
HFD4/3-L	3	2.25	2.25	90 x (1±10%)	100	6.0
HFD4/4.5-L	4.5	3.38	3.38	203 x (1±10%)	100	9.0
HFD4/5-L	5	3.75	3.75	250 x (1±10%)	100	10.0
HFD4/6-L	6	4.5	4.5	360 x (1±10%)	100	12.0
HFD4/9-L	9	6.75	6.75	810 x (1±10%)	100	18.0
HFD4/12-L	12	9	9	1440 x (1±10%)	100	24.0
HFD4/24-L	24	18	18	2880 x (1±10%)	200	36.0

Notes: 1) When user's requirements can't be found in the above table, special order allowed.

2) In case 5V of transistor drive circuit, it is recommended to use 4.5V type relay, and 3V to use 2.4V type relay.

ORDERING INFORMATION

	HFD4 /	24	-L	4	S	R	(XXX)
Type							
Coil voltage	1.5, 2.4, 3, 4.5, 5, 6, 9, 12, 24VDC						
Sort	L: 1 coil latching		Nil: Single side stable				
Contact material	4: AgPd+Gold plated		Nil: AgNi+Gold plated				
Terminal type	S: Standard SMT		S1: Short terminal SMT		Nil: DIP		
Packing style	R: Tape and reel packing (Only for SMT type) ¹⁾ Nil: Tube packing(Only for DIP type)						
Special code²⁾	XXX: Customer special requirement			Nil: Standard			

Notes: 1) R type (tape and reel) packing is moisture-proof which meets requirement of MSL-3. Please choose R type packing for SMT products. For R type, the letter "R" will only be printed on packing tag but not on relay cover. Tube packing is normally not available for SMT products unless specially requested by customer. But please note that tube packing is not moisture-proof so please bake the products before use according to description of Notice 10 herewith. In addition, tube packaging will be adopted when the ordering quantity of R type is equal to or less than 100 pieces unless otherwise specified.

2) The customer special requirement express as special code after evaluating by Hongfa.

OUTLINE DIMENSIONS, WIRING DIAGRAM AND PC BOARD LAYOUT

Unit: mm

Outline Dimensions

PCB Layout (Bottom view)

DIP type

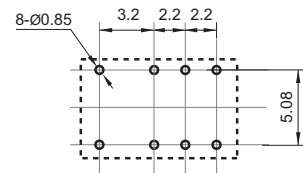
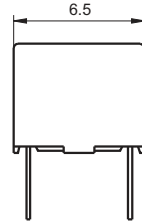
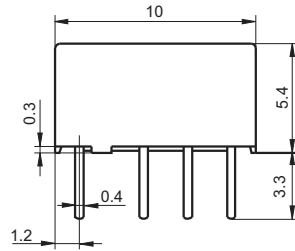

Standard SMT type

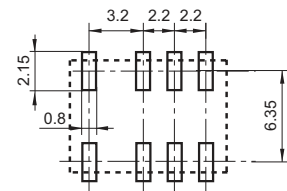
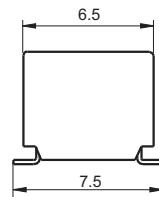
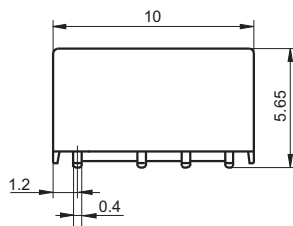

Short terminal SMT type

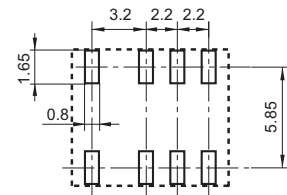
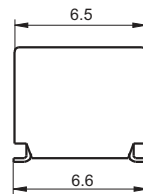
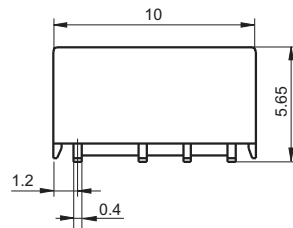

Wiring Diagram (Bottom view)

Single side stable

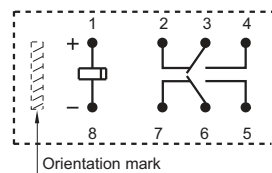

No energized condition

1 coil latching

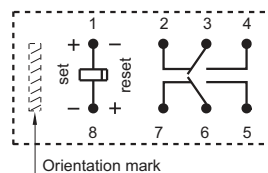

Reset condition

- Remark: 1) In case of no tolerance shown in outline dimension: outline dimension $\leq 1\text{mm}$, tolerance should be $\pm 0.2\text{mm}$; outline dimension $> 1\text{mm}$ and $\leq 5\text{mm}$, tolerance should be $\pm 0.3\text{mm}$; outline dimension $> 5\text{mm}$, tolerance should be $\pm 0.4\text{mm}$.
2) The tolerance without indicating for PCB layout is always $\pm 0.1\text{mm}$.

Direction of Relay Insertion

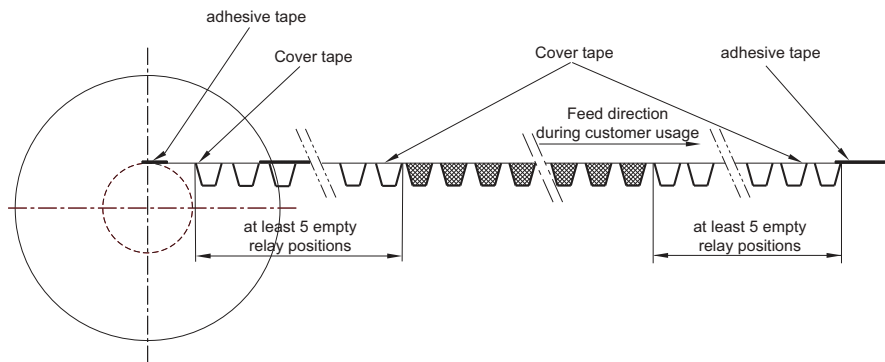
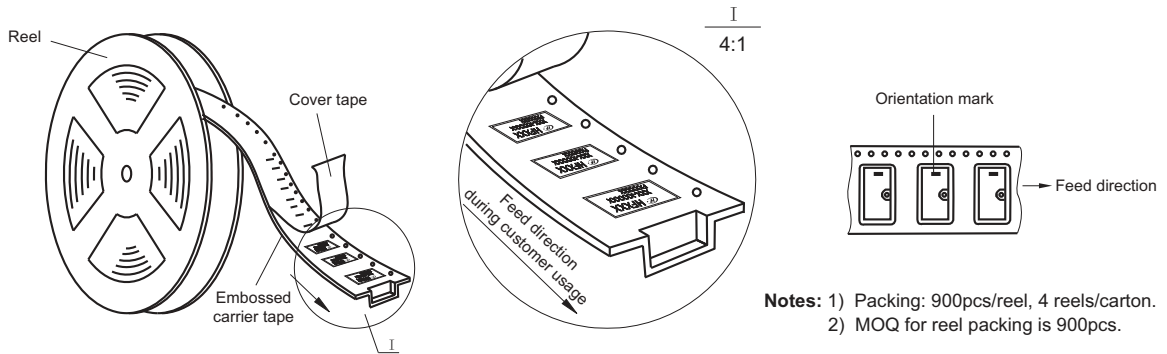

Reel Dimensions

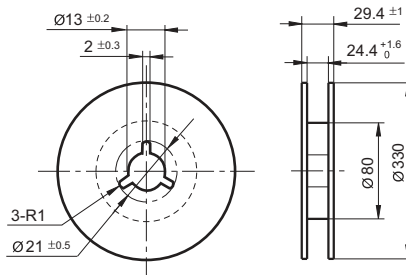

Tape Dimensions (S type: Standard SMT)

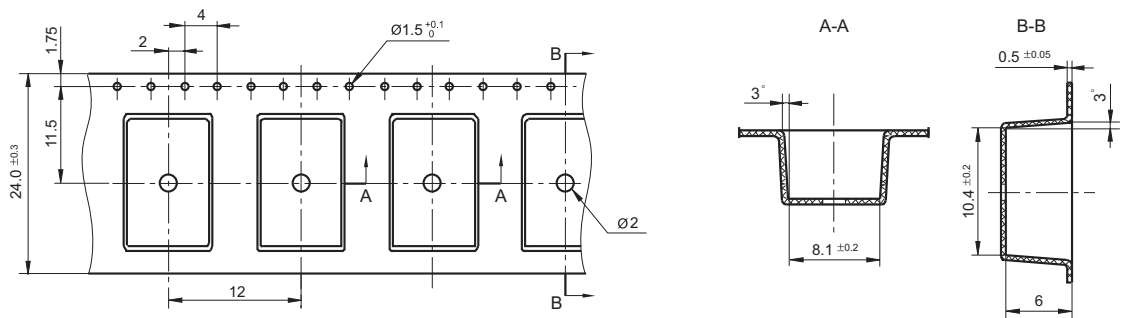

Tape Dimensions (S1 type: Short terminal SMT)

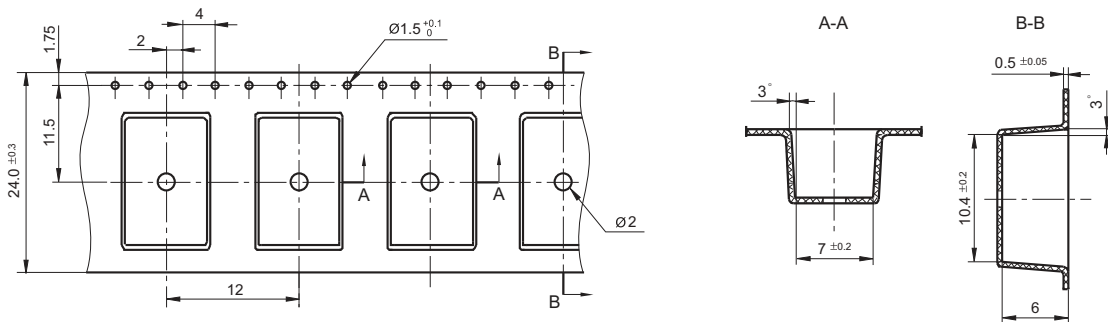

- Remark: 1) In case of no tolerance shown in outline dimension: outline dimension ≤ 1 mm, tolerance should be ± 0.2 mm; outline dimension > 1 mm and ≤ 5 mm, tolerance should be ± 0.3 mm; outline dimension > 5 mm, tolerance should be ± 0.4 mm.
 2) The tolerance without indicating for PCB layout is always ± 0.1 mm.
 3) The width of the gridding is 2.54mm.

CHARACTERISTIC CURVES

MAXIMUM SWITCHING POWER

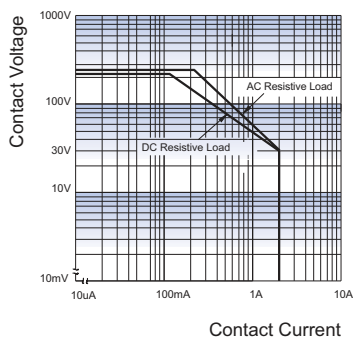

ENDURANCE CURVE

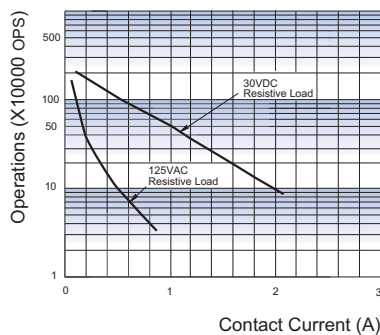

Test conditions:

Resistive load, at 40°C, 1s on 9s off.

**REFLOW WELDING TEMPERATURE ON PCB BOARD
RECOMMENDED WELDING TEMPERATURE**

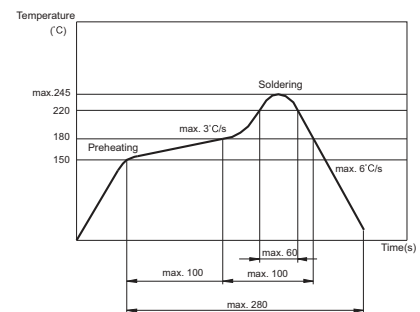

Notice

- 1) This relay is highly sensitive polarized relay, if correct polarity is not applied to the coil terminals, the relay does not operate properly.
- 2) To avoid using relays under strong magnetic field which will change the parameters of relays such as pick-up voltage and drop-out voltage.
- 3) Relay is on the "reset" status when being released from stock, with the consideration of shock risen from transit and relay mounting, it should be changed to the "set" status when application(connecting to the power supply). Please reset the relay to "set" or "reset" status on request.
- 4) Energizing coil with rated voltage is basic for normal operation of a relay, please make sure the energized voltage to relay coil have reached the rated voltage. Regarding latching relay, in order to maintain the "set" or "reset" status, impulse width of the rated voltage applied to coil should be more than 5 times of "set" or "reset" time.
- 5) The relay may be damaged because of falling or when shocking conditions exceed the requirement.
- 6) For SMT products, validation with real application should be done before your series production, if the reflow-soldering temperature curve is out of our recommendation. Generally, two-time reflow-soldering is not recommended for the relay. However, if two-time reflow-soldering is required, a 60-min. interval should be guaranteed and a validation should be done before production.
- 7) Contact is recommended for suitable condition and specifications if water cleaning or surface process is involved in assembling relays on PCB.
- 8) Regarding the plastic sealed relay, we should leave it cooling naturally until below 40°C after welding, then clean it and deal with coating, remarkably the temperature of solvents should also be controlled below 40°C. Please avoid cleaning the relay by ultrasonic, avoid using the solvents like gasoline, Freon, and so on, which would affect the configuration of relay or influence the environment.
- 9) About preferable condition of operation, storage and transportation, please refer to "Explanation to terminology and guidelines of relay".
- 10) Relays packaged in moisture barrier bags meet MSL-3 requirements. The relays should be stored at ambient conditions of $\leq 30^\circ\text{C}$ and $\leq 60\%$ RH after they are removed from their packaging, and should be used within 168 hours. If the relays cannot be used within 168 hours, please repack them or store them in a drying oven at $25^\circ\text{C} \pm 5^\circ\text{C}$, $\leq 10\%$ RH. Otherwise, relays may be subjected to a soldering test to check their performance, or they may be used after keeping them in an oven for 72 hours at with $50^\circ\text{C} \pm 5^\circ\text{C}$, $\leq 30\%$ RH.

Disclaimer

The specification is for reference only. See to "Terminology and Guidelines" for more information. Specifications subject to change without notice. We could not evaluate all the performance and all the parameters for every possible application. Thus the user should be in a right position to choose the suitable product for their own application. If there is any query, please contact Hongfa for the technical service. However, it is the user's responsibility to determine which product should be used only.

HFD42

SUBMINIATURE SIGNAL RELAY



File No.:E133481



File No.:R50317623

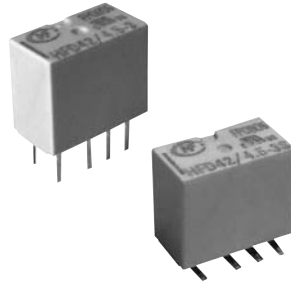

Features

- Offers excellent board space savings
- Surge withstand voltage up to 2500V, meets FCC Part 68 and Telecordia
- Meets EN60950/EN41003
- SMT and DIP types available
- High contact capacity 2A 30VDC
- Low power consumption
- Single side stable and latching type available
- Environmental friendly product (RoHS compliant)
- Outline Dimensions: (10.6 x 5.7 x 9) mm

CONTACT DATA

Contact arrangement	2C
Contact resistance	100mΩ max. (at 10mA 30mVDC)
Contact material	AgNi + Au plated, AgPd + Au plated
Contact rating (Res. load)	1A 30VDC 0.5A 125VAC 2A 30VDC 1A 125VAC
Max. switching current	4A
Max. switching voltage	250VAC / 220VDC
Max. switching power	125VA / 120W
Min. applicable load	10mV 10μA
Mechanical endurance	1 x 10 ⁸ ops
Electrical endurance	1 x 10 ⁵ ops(1A 30VDC) 1 x 10 ⁵ ops(0.5A 125VAC)

COIL

Coil power	Single side stable: 140mW、230mW
	1 coil latching: 100mW、120mW

SAFETY APPROVAL RATINGS

UL/CUL	1A 30VDC 85°C
	0.5A 125VAC 85°C
	2A 30VDC 85°C
	1A 125VAC 85°C
TÜV	0.5A 125VAC 85°C
	1A 30VDC 85°C
	2A 30VDC 85°C
	1A 125VAC 85°C

Notes: 1) All values unspecified are at room temperature.
2) Only typical loads are listed above. Other load specifications can be available upon request.

CHARACTERISTICS

Insulation resistance		1000MΩ (at 500VDC)
Dielectric strength	Between coil & contacts	1500VAC 1min
	Between open contacts	1000VAC 1min
	Between contact sets	1800VAC 1min
Surge withstand voltage		
Between open contacts (10/160μs)		1500VAC (FCC part 68)
Between coil & contacts (2/10μs)		2500VAC (Telecordia)
Operate time (Set time)		3ms max.
Release time (Reset time)		3ms max.
Ambient temperature		-40°C to 85°C
Humidity		5% to 85% RH
Vibration resistance	Functional	10Hz to 55Hz 3.3mm DA
	Destructive	10Hz to 55Hz 5.0mm DA
Shock resistance	Functional	735m/s ²
	Destructive	980m/s ²
Termination		DIP, SMT
Unit weight		Approx. 1.1g
Moisture sensitivity levels (Only for SMT type, JEDEC-STD-020)		MSL3
Construction		Plastic sealed

Notes: 1) The data shown above are initial values.



HONGFA RELAY

ISO9001, ISO/TS16949, ISO14001, OHSAS18001, IECQ QC 080000 CERTIFIED

COIL DATA

at 23°C

Single side stable

Coil Code	Nominal Voltage VDC	Pick-up Voltage VDC max.	Drop-out Voltage VDC min.	Coil Resistance Ω	Max. Voltage VDC
HFD42/1.5	1.5	1.13	0.15	16 x (1±10%)	2.2
HFD42/2.4	2.4	1.8	0.24	41 x (1±10%)	3.6
HFD42/3	3	2.25	0.3	64.3 x (1±10%)	4.5
HFD42/4.5	4.5	3.38	0.45	145 x (1±10%)	6.7
HFD42/5	5	3.75	0.5	178 x (1±10%)	7.5
HFD42/6	6	4.5	0.6	257 x (1±10%)	9.0
HFD42/9	9	6.75	0.9	579 x (1±10%)	13.5
HFD42/12	12	9	1.2	1028 x (1±10%)	18.0
HFD42/24	24	18	2.4	2504 x (1±10%)	36.0

Notes: 1) Maximum voltage refers to the maximum voltage which relay coil could endure in a short period of time.

1 coil latching

Coil Code	Nominal Voltage VDC	Set Voltage VDC max.	Reset Voltage VDC max.	Coil Resistance Ω	Max. Voltage VDC
HFD42/1.5-L	1.5	1.13	1.13	22.5 x (1±10%)	3.0
HFD42/2.4-L	2.4	1.8	1.8	58 x (1±10%)	4.8
HFD42/3-L	3	2.25	2.25	90 x (1±10%)	6.0
HFD42/4.5-L	4.5	3.38	3.38	203 x (1±10%)	9.0
HFD42/5-L	5	3.75	3.75	250 x (1±10%)	10.0
HFD42/6-L	6	4.5	4.5	360 x (1±10%)	12.0
HFD42/9-L	9	6.75	6.75	810 x (1±10%)	18.0
HFD42/12-L	12	9	9	1440 x (1±10%)	24.0
HFD42/24-L	24	18	18	2880 x (1±10%)	36.0

Notes: 1) When user's requirements can't be found in the above table, special order allowed.

2) In case 5V of transistor drive circuit, it is recommended to use 4.5V type relay, and 3V to use 2.4V type relay.

ORDERING INFORMATION

Type	HFD42 / 24 -L1 4 S R (XXX)						
Coil voltage	1.5, 2.4, 3, 4.5, 6, 9, 12, 24VDC						
Sort	L1: 1 coil latching		Nil: Single side stable				
Contact material	3: AgNi+Gold plated		4: AgPd+Gold plated				
Terminal type	S: Standard SMT		S1: Short terminal SMT		Nil: DIP		
Packing style	R: Tape and reel packing (Only for SMT type) ¹⁾ Nil: Tube packing(Only for DIP type)						
Special code ²⁾	XXX: Customer special requirement			Nil: Standard			

Notes: 1) R type (tape and reel) packing is moisture-proof which meets requirement of MSL-3. Please choose R type packing for SMT products. For R type, the letter "R" will only be printed on packing tag but not on relay cover. Tube packing is normally not available for SMT products unless specially requested by customer. But please note that tube packing is not moisture-proof so please bake the products before use according to description of Notice 10 herewith. In addition, tube packaging will be adopted when the ordering quantity of R type is equal to or less than 100 pieces unless otherwise specified.

2) The customer special requirement express as special code after evaluating by Hongfa.

OUTLINE DIMENSIONS, WIRING DIAGRAM AND PC BOARD LAYOUT

Unit: mm

Outline Dimensions

PCB Layout

(Bottom view)

DIP type

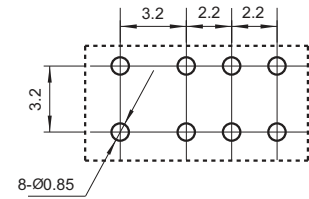
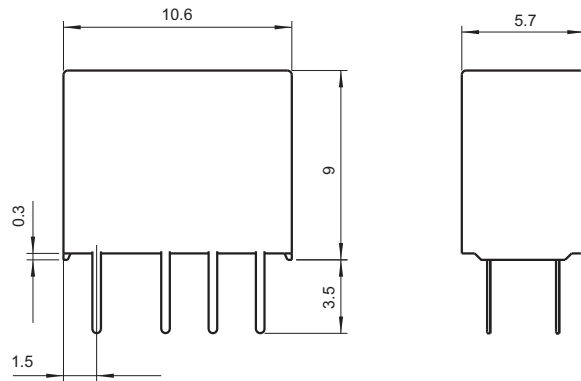

Standard SMT type

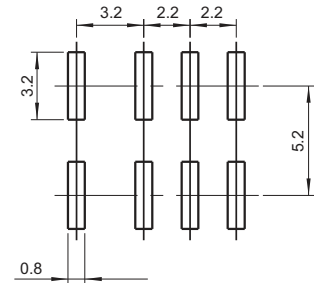
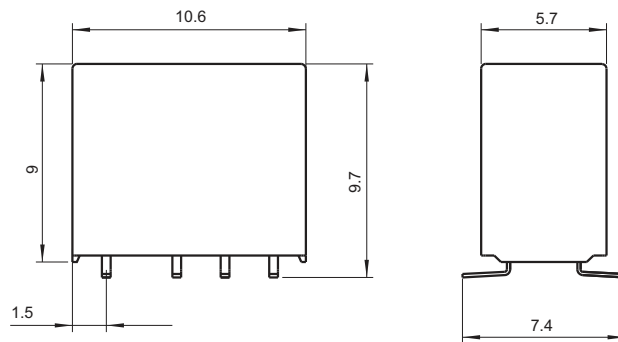

Short terminal SMT type

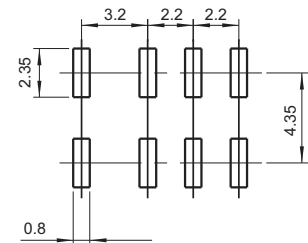
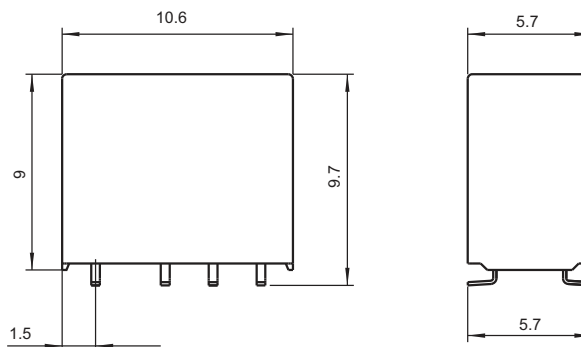

Wiring Diagram

(Bottom view)

Single side stable

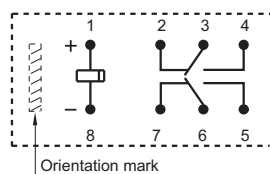

No energized condition

1 coil latching

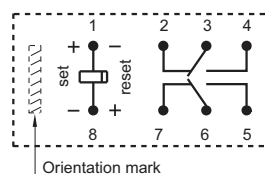

Reset condition

Remark: 1) In case of no tolerance shown in outline dimension: outline dimension ≤ 1 mm, tolerance should be ± 0.2 mm; outline dimension > 1 mm and ≤ 5 mm, tolerance should be ± 0.3 mm; outline dimension > 5 mm, tolerance should be ± 0.4 mm.

2) The tolerance without indicating for PCB layout is always ± 0.1 mm.

3) The width of the gridding is 2.5mm.

Direction of Relay Insertion

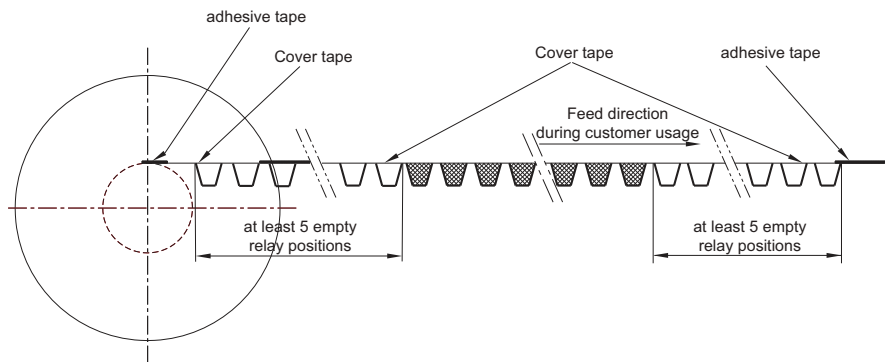
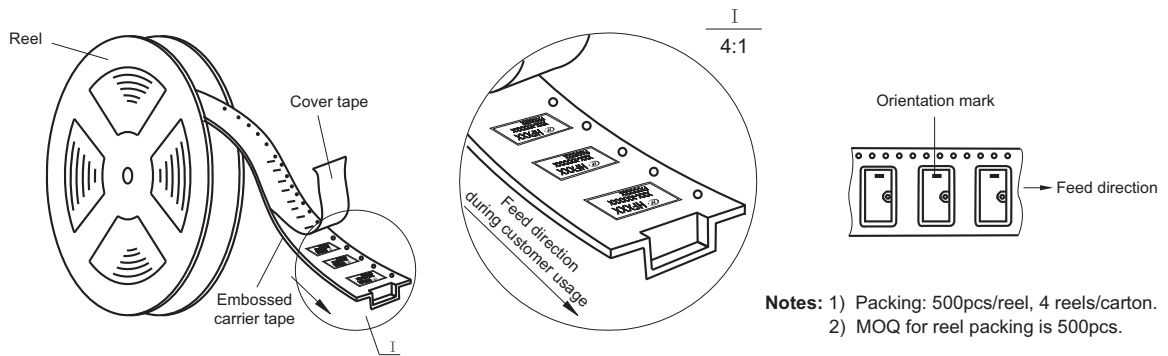

Reel Dimensions

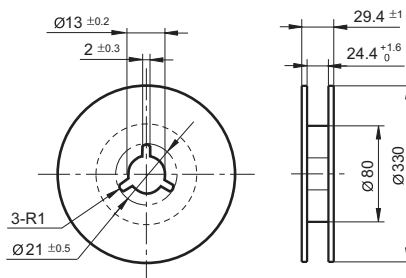

Tape Dimensions (S type: Standard SMT)

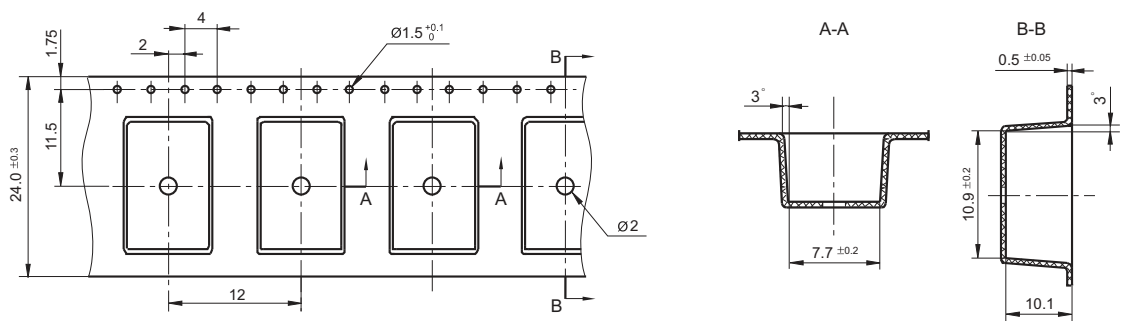

Tape Dimensions (S1 type: Short terminal SMT)

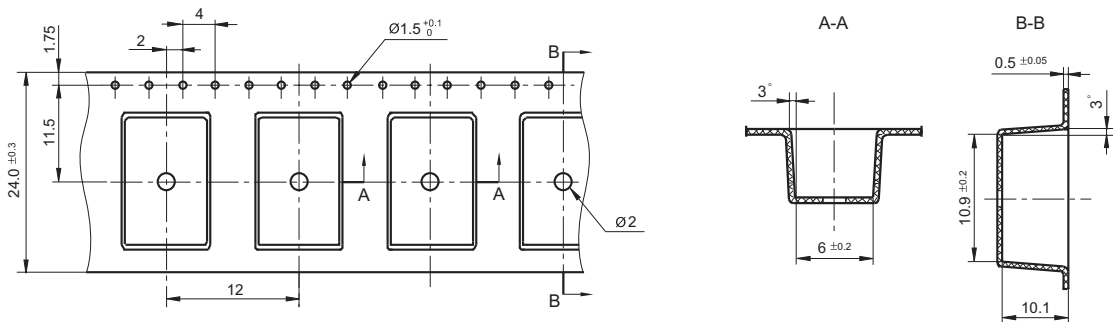

- Remark: 1) In case of no tolerance shown in outline dimension: outline dimension ≤1mm, tolerance should be ±0.2mm; outline dimension >1mm and ≤5mm, tolerance should be ±0.3mm; outline dimension >5mm, tolerance should be ±0.4mm.
 2) The tolerance without indicating for PCB layout is always ±0.1mm.
 3) The width of the gridding is 2.54mm.

CHARACTERISTIC CURVES

MAXIMUM SWITCHING POWER

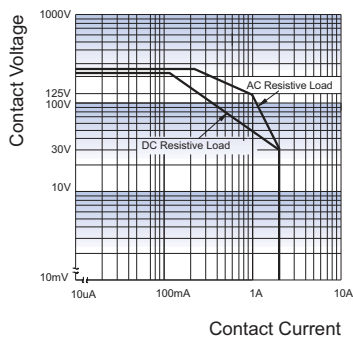

ENDURANCE CURVE

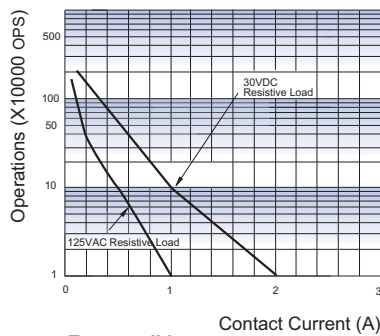

Test conditions:

Resistive load, at 40°C, 1s on 9s off.

REFLOW WELDING, TEMPERATURE ON PCB BOARD

RECOMMENDED WELDING TEMPERATURE

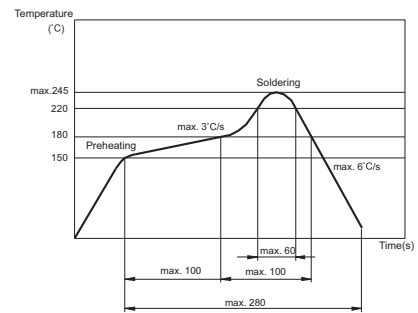

Notice

- 1) This relay is highly sensitive polarized relay, if correct polarity is not applied to the coil terminals, the relay does not operate properly.
- 2) To avoid using relays under strong magnetic field which will change the parameters of relays such as pick-up voltage and drop-out voltage.
- 3) Relay is on the "reset" status when being released from stock, with the consideration of shock risen from transit and relay mounting, it should be changed to the "set" status when application(connecting to the power supply). Please reset the relay to "set" or "reset" status on request.
- 4) Energizing coil with rated voltage is basic for normal operation of a relay, please make sure the energized voltage to relay coil have reached the rated voltage. Regarding latching relay, in order to maintain the "set" or "reset" status, impulse width of the rated voltage applied to coil should be more than 5 times of "set" or "reset" time.
- 5) The relay may be damaged because of falling or when shocking conditions exceed the requirement.
- 6) For SMT products, validation with real application should be done before your series production, if the reflow-soldering temperature curve is out of our recommendation. Generally, two-time reflow-soldering is not recommended for the relay. However, if two-time reflow-soldering is required, a 60-min. interval should be guaranteed and a validation should be done before production.
- 7) Contact is recommended for suitable condition and specifications if water cleaning or surface process is involved in assembling relays on PCB.
- 8) Regarding the plastic sealed relay, we should leave it cooling naturally until below 40°C after welding, then clean it and deal with coating, remarkably the temperature of solvents should also be controlled below 40°C. Please avoid cleaning the relay by ultrasonic, avoid using the solvents like gasoline, Freon, and so on, which would affect the configuration of relay or influence the environment.
- 9) About preferable condition of operation, storage and transportation, please refer to "Explanation to terminology and guidelines of relay".
- 10) Relays packaged in moisture barrier bags meet MSL-3 requirements. The relays should be stored at ambient conditions of ≤30°C and ≤60% RH after they are removed from their packaging, and should be used within 168 hours. If the relays cannot be used within 168 hours, please repack them or store them in a drying oven at 25°C ±5°C, ≤10% RH. Otherwise, relays may be subjected to a soldering test to check their performance, or they may be used after keeping them in an oven for 72 hours at with 50°C ±5°C, ≤30% RH.

Disclaimer

The specification is for reference only. See to "Terminology and Guidelines" for more information. Specifications subject to change without notice. We could not evaluate all the performance and all the parameters for every possible application. Thus the user should be in a right position to choose the suitable product for their own application. If there is any query, please contact Hongfa for the technical service. However, it is the user's responsibility to determine which product should be used only.

2

Power Relay

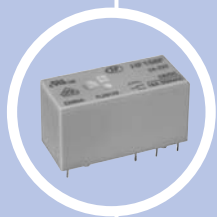
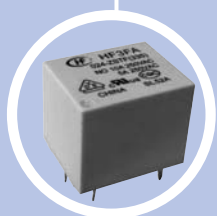

HF49FD	78	HF115F-L 2 pole	195
HF41F	81	HF115F-LS	198
HF46F	85	HF115FP	201
HF46F-G	88	HF115FK	204
HF42F	91	HF115FK-T	207
HF32FA	94	HF158F	210
HF32FA-T	97	HF158F-V	213
HF32FA-G	100	HF141FF	216
HF32FV	103	HF14FF	219
HF32FV-G	106	HF14FW	222
HF32F	109	HF140FF	225
HF32F-G	112	HF25F	229
HF33F	114	HF62F	233
HF36F	117	HF102F	236
HF36FD	120	HF161F	239
HF162F	122	HF161F-W	242
HF8	124	HF160F	245
HF3FA	127	HF166F	248
HF3FD	130	HF37F	251
HF3FF	133	HF165FD	254
HF3F-L	136	HF165FD-G	258
HF3FF-M	139	HF165F	261
HF7FF	142	HF105F-1	264
HF7FD	145	HF105F-2	270
HF21FF	148	HF105F-4	274
HF152F	151	HF105F-5	278
HF152FD	154	HF2100	282
HF7520	157	HF2110/HF2120	286
HF163F-L	161	HF2150	292
HFE7	164	HF2160	296
HF118F	168	HF116F-1	300
HF115F	171	HF116F-2	304
HF115F-A	175	HF116F-3	308
HF115F-T/TH	178	HF116F-G	312
HF115F-H	181	HF116F-80	316
HF115F-I	184	HF92F	318
HF115F-Q	187	HF84F	322
HF115F-S	190	HF94F	324
HF115F-L 1 pole	192	HF8565	327

HF49FD

MINIATURE POWER RELAY



File No. : E133481



File No. : 40033644



File No. : R50149334



File No.:CQC10002049162



Features

- 5A switching capability
- 3kV dielectric strength (between coil and contacts)
- Slim size (width 5mm, height 12.5mm)
- High sensitive: Min. 120mW
- Meets IEC61131-2 reinforce insulation
- Creepage/clearance distance: Min. 3.5mm
- Sockets available
- UL insulation system: Class F available
- Environmental friendly product (RoHS compliant)
- Outline Dimensions: (20.0 x 5.0 x 12.5) mm

CONTACT DATA

Contact arrangement	1A
Contact Resistance (at 1A 6VDC)	No gold plated: 100mΩ max. Gold plated: 50mΩ max.
Contact material	AgSnO ₂ , AgNi
Contact rating (Res. load)	5A 250VAC/30VDC
Max. switching voltage	250VAC /30VDC
Max. switching current	5A
Max. switching power	1250VA / 150W
Min. contact load ¹⁾	No gold plated: 5VDC 10mA Gold plated: 5VDC 1mA
Mechanical endurance	2 x 10 ⁷ OPS
Electrical endurance	1 x 10 ⁵ OPS (3A 250VAC/30VDC, Resistive load, AgNi, at 85°C, 1s on 9s off) 5 x 10 ⁴ OPS (5A 250VAC/30VDC, Resistive load, AgNi, Room temp., 1s on 9s off)

Notes: 1) Min. contact load is reference value. Please perform the confirmation test with the actual load before usage since reference value may change according to switching frequencies, environmental conditions and expected life cycles.

CHARACTERISTICS

Insulation resistance	1000MΩ (at 500VDC)	
Dielectric strength	Between coil & contacts	3000VAC 1min
	Between open contacts	1000VAC 1min
Surge voltage(between coil & contacts)	6kV (1.2 / 50μs)	
Operate time (at nomi.volt.)	10ms max.	
Release time (at nomi.volt.)	5ms max.	
Shock resistance	Functional	98m/s ²
	Destructive	980m/s ²
Vibration resistance	10Hz to 55Hz 1.5mm DA	
Humidity	5% to 85% RH	
Ambient temperature	-40°C to 85°C	
Termination	PCB	
Unit weight	Approx. 3g	
Construction	Plastic sealed	

Notes: 1) The data shown above are initial values.
2) Please find coil temperature curve in the characteristic curves below.
3) UL insulation system: Class F, Class B, Class A.

COIL

Coil power	Approx. 120mW (at 5VDC to 18VDC)
	Approx. 180mW (at 24VDC)

COIL DATA

at 23°C

Nominal Voltage VDC	Pick-up Voltage VDC max.	Drop-out Voltage VDC min.	Max. Voltage VDC *	Coil Resistance Ω
5	3.50	0.25	6.0	208 x (±10%)
6	4.20	0.30	7.2	300 x (±10%)
9	6.30	0.45	10.8	675 x (±10%)
12	8.40	0.60	14.4	1200 x (±10%)
18	12.6	0.90	21.6	2700 x (±15%)
24	16.8	1.20	28.8	3200 x (±15%)

Notes: 1) All above data are tested when the relays terminals are downward position. Other positions of the terminals, the pick-up and drop-out voltages will have ±5% tolerance. For example, when the relay terminals are transverse position, the max. pick-up voltage change is 75% of nominal voltage.

2) *Maximum voltage refers to the maximum voltage which relay coil could endure in a short period of time.

3) 24VDC 120mW type are also available, please see ordering information for more details.

SAFETY APPROVAL RATINGS

UL/CUL	1H1 type	AgSnO ₂	3A 250VAC COSØ=1 at 85°C 3A 30VDC L/R =0ms at 85°C
		AgNi	5A 250VAC COSØ=1 5A 30VDC L/R =0ms
VDE	1H2 type	AgNi	3A 250VAC COSØ=1 at 85°C 3A 30VDC L/R =0ms at 85°C
			5A 250VAC COSØ=1 5A 30VDC L/R =0ms
TÜV			5A 250VAC COSØ=1 at 85°C 5A 30VDC L/R =0ms at 85°C
			5A 250VAC COSØ=1 at 70°C 5A 30VDC L/R =0ms at 70°C

Notes: 1) All values unspecified are at room temperature.

2) Only typical loads are listed above. Other load specifications can be available upon request.



HONGFA RELAY

ISO9001, ISO/TS16949, ISO14001, OHSAS18001, IECQ QC 080000 CERTIFIED

ORDERING INFORMATION

Type		HF49FD / 012 -1H 1 2 G T F L (XXX)	
Coil voltage	5, 6, 9, 12, 18, 24VDC		
Contact arrangement	1H: 1 Form A		
Contact version	1: Single contact 2: Bifurcated contact(Only for gold plated)		
Space between terminals	(See the following) 1: 5.08mm 2: 7.62mm		
Contact plating	G: Gold plated Nil: No gold plated (Only for single contact)		
Contact material	T: AgSnO ₂ (Only for single contact)		Nil: AgNi
Insulation standard	F: Class F	B: Class B	Nil: Class A
Coil power	L: Sensitive (Only for 24VDC)		Nil: Standard
Special code ²⁾	XXX: Customer special requirement		Nil: Standard

- Notes: 1) Contact is recommended for suitable condition and specifications if water cleaning or surface process is involved in assembling relays on PCB.
 2) The customer special requirement express as special code after evaluating by Hongfa.
 3) If customer need to fix HF49FD in 49F socket(HF49FD+49F socket) in application, please choose HF49FD relay with suffix (009) or suffix (086).

OUTLINE DIMENSIONS, WIRING DIAGRAM AND PC BOARD LAYOUT

Outline Dimensions

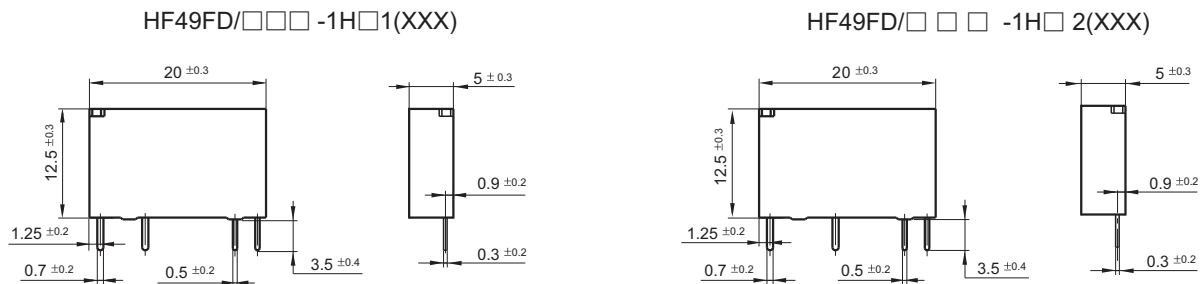

PCB Layout (Bottom view)

HF49FD/□□□-1H□1(XXX)

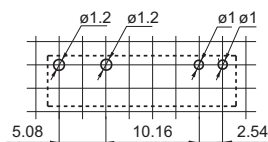

HF49FD/□□□-1H□2(XXX)

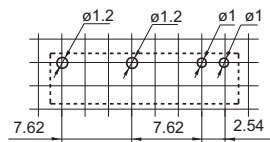

Wiring Diagram (Bottom view)



- Remark: 1) In case of no tolerance shown in outline dimension: outline dimension ≤ 1 mm, tolerance should be ± 0.2 mm; outline dimension > 1 mm and ≤ 5 mm, tolerance should be ± 0.3 mm; outline dimension > 5 mm, tolerance should be ± 0.4 mm.
 2) The tolerance without indicating for PCB layout is always ± 0.1 mm.
 3) The width of the gridding is 2.54mm.

CHARACTERISTIC CURVES

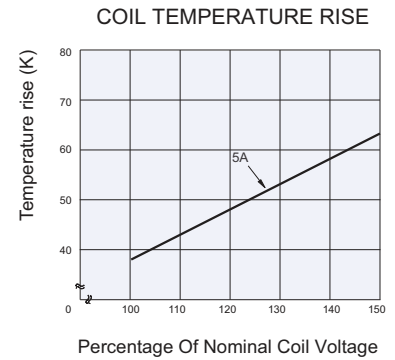
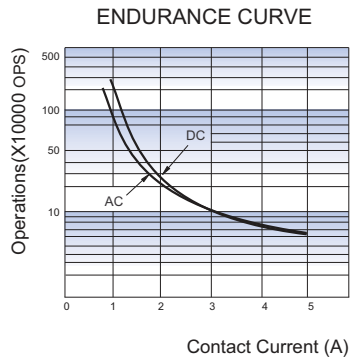
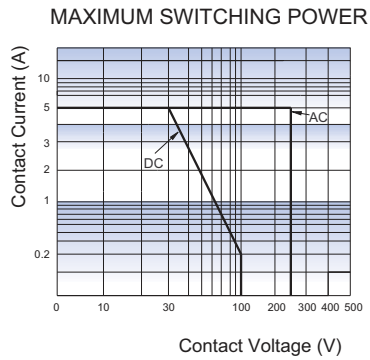

Test conditions:
 1H1 type: AgNi, Resistive load, 250VAC/30VDC,
 Room temp., 1s on 9s off.

Test conditions:
 5A 85°C
 (Typical curve of 24VDC standard type)

Disclaimer

The specification is for reference only. See to "Terminology and Guidelines" for more information. Specifications subject to change without notice. We could not evaluate all the performance and all the parameters for every possible application. Thus the user should be in a right position to choose the suitable product for their own application. If there is any query, please contact Hongfa for the technical service. However, it is the user's responsibility to determine which product should be used only.

© Xiamen Hongfa Electroacoustic Co., Ltd. All rights of Hongfa are reserved.

HF41F

SUBMINIATURE POWER RELAY



File No.: E133481



File No.: 40020043



File No.: CQC09002035072

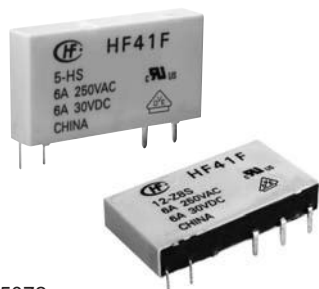

Features

- Slim size (width 5mm)
- High breakdown voltage 4kV (between coil and contacts)
- Surge voltage up to 6kV (between coil and contacts)
- Meeting VDE 0700, 0631 reinforce insulation
- High sensitive: Approx.170mW
- Sockets available
- 1 Form A and 1 Form C configurations
- Environmental friendly product (RoHS compliant)
- Outline Dimensions: (28.0 x 5.0 x 15.0) mm

CONTACT DATA

Contact arrangement	1A, 1C
Contact resistance	No gold plated:100mΩ max. (at 1A 6VDC) Gold plated: 30mΩ max. (at 1A 6VDC)
Contact material	AgSnO ₂ , AgNi
Contact rating (Res. load)	6A 250VAC / 30VDC
Max. switching voltage	400VAC / 125VDC
Max. switching current	6A
Max. switching power	1500VA / 180W
Mechanical endurance	1 x 10 ⁷ ops
Electrical endurance	H type: 6 x 10 ⁴ ops (6A 250VAC/30VDC, Resistive load, AgNi, at 85°C, 1s on 9s off) Z type: 3 x 10 ⁴ ops (NO, 6A 250VAC/30VDC, Resistive load, AgNi, at 85°C, 1s on 9s off) 1 x 10 ⁴ ops (NC, 6A 250VAC/30VDC, Resistive load, AgNi, at 85°C, 1s on 9s off)

CHARACTERISTICS

Insulation resistance	1000MΩ (at 500VDC)
Dielectric strength	Between coil & contacts 4000VAC 1 min
	Between open contacts 1000VAC 1 min
Operate time (at nomi.volt.)	8ms max.
Release time (at nomi.volt.)	4ms max.
Shock resistance ¹⁾	Functional 49m/s ²
	Destructive 980m/s ²
Vibration resistance ¹⁾	10Hz to 55Hz 1mm DA
Humidity	5% to 85% RH
Ambient temperature	-40°C to 85°C
Termination	PCB
Unit weight	Approx. 5g
Construction	Plastic sealed, Flux proofed

- Notes: 1) Index is that of relay without socket.
2) The data shown above are initial values.
3) Please find coil temperature curve in the characteristic curves below.
4) Please do not install a SPDT(1 Form C) type relay on either of the smallest sides or facing downward.
5) UL insulation system: Class A.

COIL

Coil power	5VDC to 24VDC: Approx. 170mW 48VDC, 60VDC: Approx. 210mW
------------	---

COIL DATA

at 23°C

Nominal Voltage VDC	Pick-up Voltage VDC max.	Drop-out Voltage VDC min.	Max. Voltage VDC ²⁾	Coil Resistance Ω
5	3.75	0.25	7.5	147 x (1±10%)
6	4.50	0.30	9.0	212 x (1±10%)
9	6.75	0.45	13.5	476 x (1±10%)
12	9.00	0.60	18	848 x (1±10%)
18	13.5	0.90	27	1906 x (1±15%)
24	18.0	1.20	36	3390 x (1±15%)
48 ³⁾	36.0	2.40	72	10600 x (1±15%)
60 ³⁾	45.0	3.00	90	16600 x (1±15%)

- Notes: 1) When require pick-up voltage ≤ 70% nominal voltage, special order allowed .
2) Maximum voltage refers to the maximum voltage which relay coil could endure in a short period of time.
3) For products with rated voltage ≥ 48V, measures should be taken to prevent coil overvoltage in order to protect coil in test and application (eg. Connect diodes in parallel).

SAFETY APPROVAL RATINGS

UL/CUL	6A 30VDC at 85°C
	6A 277VAC at 85°C
	R300 B300
VDE	6A 30VDC at 85°C 6A 250VAC at 85°C

- Notes: 1) All values unspecified are at room temperature.
2) Only typical loads are listed above. Other load specifications can be available upon request.



HONGFA RELAY

ISO9001, ISO/TS16949, ISO14001, OHSAS18001, IECQ QC 080000 CERTIFIED

ORDERING INFORMATION

Type	HF41F / 12 -H 8 S T G (XXX)					
Coil voltage	5, 6, 9, 12, 18, 24, 48, 60VDC					
Contact arrangement	H: 1 Form A		Z: 1 Form C			
Version ¹⁾	8: Flat pack version		Nil: Vertical version			
Construction ²⁾³⁾	S: Plastic sealed		Nil: Flux proofed			
Contact material	T: AgSnO ₂		Nil: AgNi			
Contact plating ⁴⁾	G: Gold plated		Nil: No gold plated			
Special code ⁵⁾	XXX: Customer special requirement		Nil: Standard			

Notes: 1) We recommend flux proofed types for the flat pack version.

2) We recommend flux proofed types for a clean environment (free from contaminations like H₂S, SO₂, NO₂, dust, etc.).

We suggest to choose plastic sealed types and validate it in real application for an unclean environment (with contaminations like H₂S, SO₂, NO₂, dust, etc.).

3) Contact is recommended for suitable condition and specifications if water cleaning or surface process is involved in assembling relays on PCB.

4) For gold plated type, the min. switching current and min. switching voltage is 10mA 5VDC.

5) The customer special requirement express as special code after evaluating by Hongfa. e.g. (210) stands for pick-up voltage less than 70% of nominal voltage. e.g. (414) stands for wide coil pin type.

OUTLINE DIMENSIONS, WIRING DIAGRAM AND PC BOARD LAYOUT

Unit: mm

Outline Dimensions

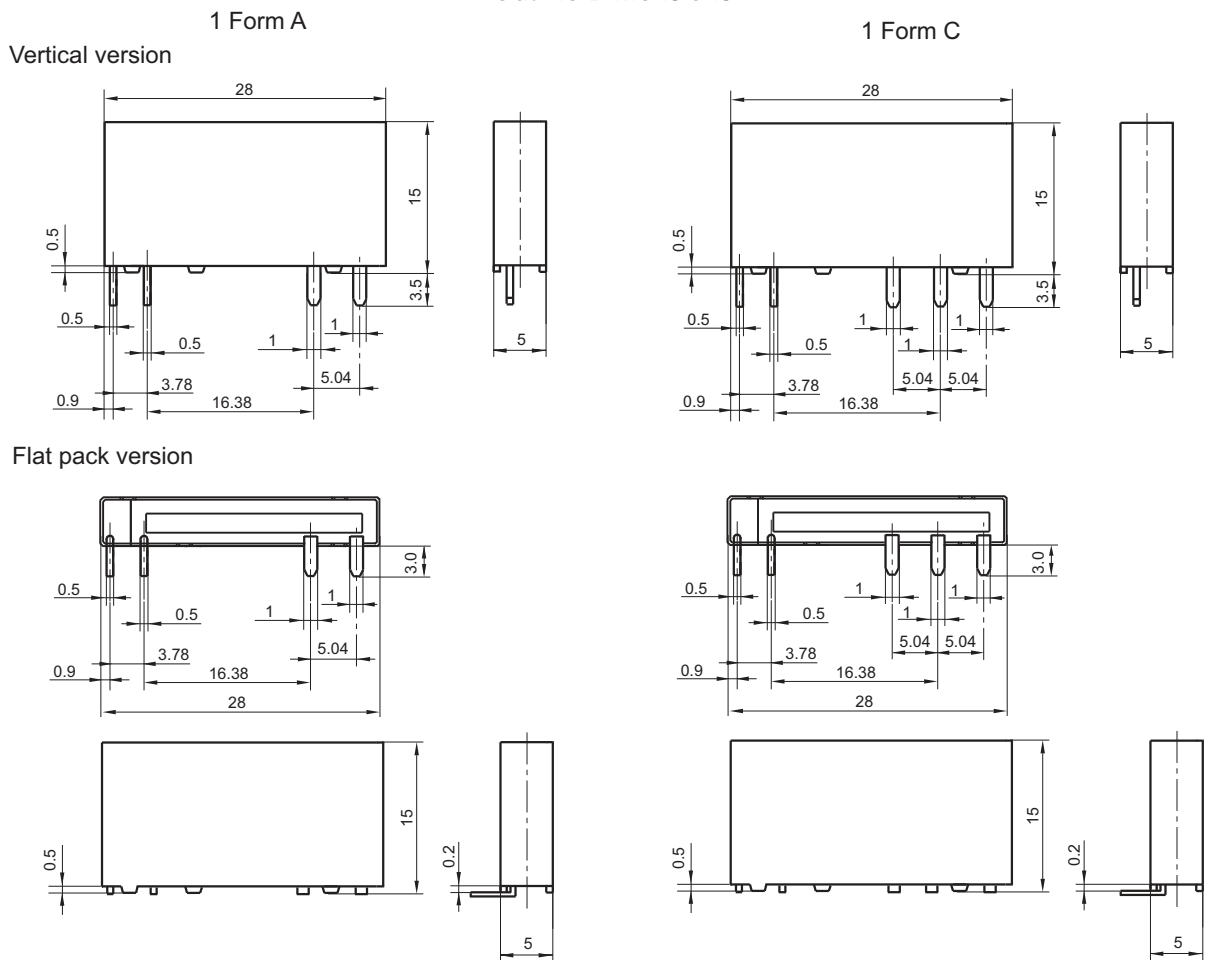

Outline Dimensions

1 Form A
Special code: (414)

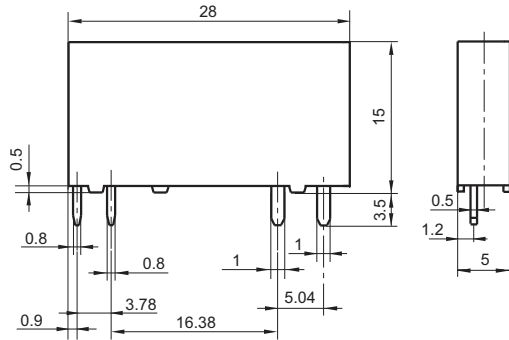

1 Form C

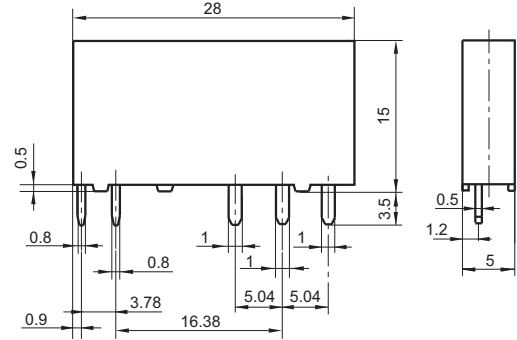

PCB Layout (Bottom view)

1 Form A

Vertical version

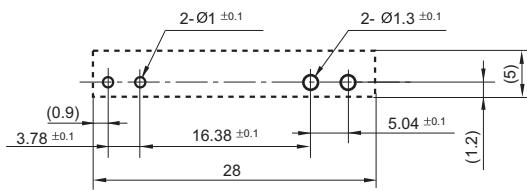

1 Form C

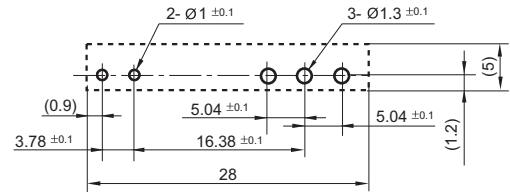

Flat pack version

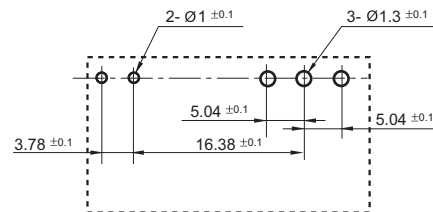
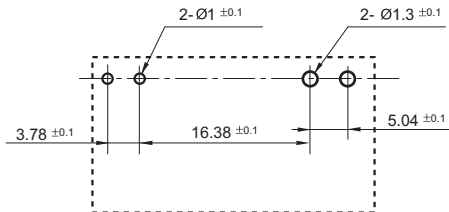

Special code: (414)

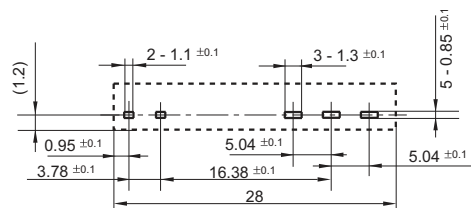
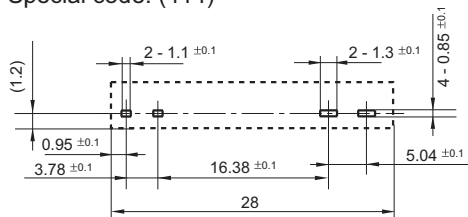

Wiring Diagram (Bottom view)

1 Form A

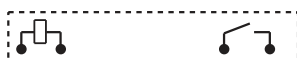

1 Form C



Remark: 1) In case of no tolerance shown in outline dimension: outline dimension $\leq 1\text{mm}$, tolerance should be $\pm 0.2\text{mm}$; outline dimension $> 1\text{mm}$ and $\leq 5\text{mm}$, tolerance should be $\pm 0.3\text{mm}$; outline dimension $> 5\text{mm}$, tolerance should be $\pm 0.4\text{mm}$.
2) The tolerance without indicating for PCB layouts is always $\pm 0.1\text{mm}$.

CHARACTERISTIC CURVES

MAXIMUM SWITCHING POWER

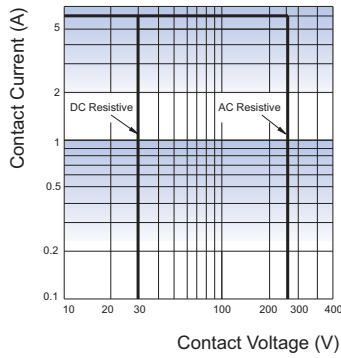

ENDURANCE CURVE

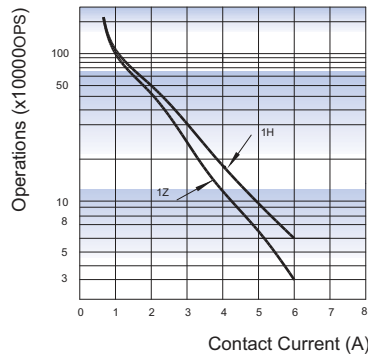

Test conditions:
NO, AgNi, Resistive load, 250VAC,
Flux proofed, Room temp., 1s on 9s off.

COIL TEMPERATURE RISE

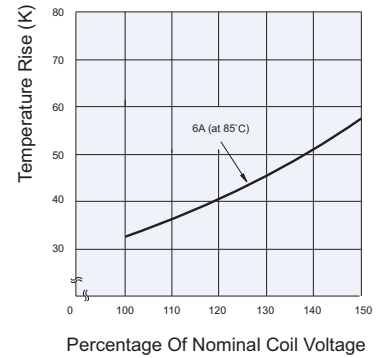

Test conditions:
6A 85°C
(Typical curve of 24VDC standard type)

Disclaimer

The specification is for reference only. See to "Terminology and Guidelines" for more information. Specifications subject to change without notice. We could not evaluate all the performance and all the parameters for every possible application. Thus the user should be in a right position to choose the suitable product for their own application. If there is any query, please contact Hongfa for the technical service. However, it is the user's responsibility to determine which product should be used only.

HF46F

SUBMINIATURE INTERMEDIATE POWER RELAY



File No.: E134517



File No.: 40025215



File No.: CQC08001024932



Features

- 5A switching capability
- 10kV impulse withstand voltage (between coil and contacts)
- Meets VDE 0631 reinforce insulation
- Highly efficient magnetic circuit for high sensitivity: 200mW
- Extremely small footprint utilizing PCB area
- UL insulation system: Class F available
- Environmental friendly product (RoHS compliant)
- Outline Dimensions: (20.5 x 7.2 x 15.3) mm

CONTACT DATA

Contact arrangement	1A
Contact resistance	100mΩ max. (at 1A 6VDC)
Contact material	AgSnO ₂ , AgNi
Contact rating (Res. load)	3A 250VAC/30VDC 5A 250VAC/30VDC
Max. switching voltage	277VAC / 30VDC
Max. switching current	5A
Max. switching power	1385VA / 150W
Mechanical endurance	5 x 10 ⁶ OPS
Electrical endurance	1 x 10 ⁵ OPS (5A 250VAC, Resistive load, AgNi, at 85°C, 1s on 1s off) 5 x 10 ⁴ OPS (5A 250VAC, Resistive load, AgSnO ₂ , at 85°C, 3s on 3s off)

CHARACTERISTICS

Insulation resistance	1000MΩ (at 500VDC)	
Dielectric strength	Between coil & contacts	4000VAC 1min
	Between open contacts	1000VAC 1min
Surge voltage (between coil & movable contacts)	10kV (1.2 / 50μs)	
Operate time (at nomi. volt.)	10ms max.	
Release time (at nomi. volt.)	10ms max.	
Shock resistance ¹⁾	Functional	98m/s ²
	Destructive	980m/s ²
Vibration resistance ¹⁾	10Hz to 55Hz 1.5mm DA	
Humidity	5% to 85% RH	
Ambient temperature	-40°C to 85°C	
Termination	PCB	
Unit weight	Approx. 3g	
Construction	Plastic sealed	

- Notes:** 1) Shock malfunction: 49m/s² for the length direction.
Vibration: 10Hz to 55Hz 1mm DA for the length direction.
2) The data shown above are initial values.
3) UL insulation system: Class F, Class B.

COIL

Coil power	Approx. 200mW
------------	---------------

COIL DATA

at 23°C

Nominal Voltage VDC	Pick-up Voltage VDC max.	Drop-out Voltage VDC min.	Max. Voltage VDC *	Coil Resistance Ω
3	2.25	0.18	3.90	45 x (1±10%)
5	3.75	0.25	6.50	125 x (1±10%)
6	4.50	0.30	7.80	180 x (1±10%)
9	6.75	0.45	11.7	405 x (1±10%)
12	9.00	0.60	15.6	720 x (1±10%)
18	13.5	0.90	23.4	1620 x (1±10%)
24	18.0	1.20	31.2	2880 x (1±10%)

Notes: * Maximum voltage refers to the maximum voltage which relay coil could endure in a short period of time.

SAFETY APPROVAL RATINGS

UL/CUL	AgNi	5A 125VAC/250VAC at 85°C 5A 277VAC/30VDC at 85°C 3A 125VAC/250VAC at 85°C 3A 277VAC/30VDC at 85°C
	AgSnO ₂	5A 125VAC/250VAC at 85°C 5A 277VAC/30VDC at 85°C 3A 125VAC/250VAC at 85°C 3A 277VAC/30VDC at 85°C B300 R300
VDE	AgNi	5A 250VAC/30VDC at 85°C
	AgSnO ₂	5A 250VAC/30VDC at 85°C

- Notes:** 1) All values unspecified are at room temperature.
2) Only typical loads are listed above. Other load specifications can be available upon request.



HONGFA RELAY

ISO9001, ISO/TS16949, ISO14001, OHSAS18001, IECQ QC 080000 CERTIFIED

ORDERING INFORMATION

Type	HF46F / 12 -H S 1 T G F (XXX)					
Coil voltage	3, 5, 6, 9, 12, 18, 24VDC					
Contact arrangement	H: 1 Form A					
Construction ¹⁾²⁾	S: Plastic sealed					
Termination	1: type 1					
Contact material ³⁾	T: AgSnO ₂		Nil: AgNi			
Contact plating	G: Gold plated		Nil: No gold plated			
Insulation standard	F: Class F		Nil: Class B			
Special code ⁵⁾	XXX: Customer special requirement			Nil: Standard		

Notes: 1) We suggest to choose plastic sealed types and validate it in real application for an unclean environment (with contaminations like H₂S, SO₂, NO₂, dust, etc).

2) Contact is recommended for suitable condition and specifications if water cleaning or surface process is involved in assembling relays on PCB.

3) For the loads which can bring high inrush current when relay contacts connect instantly (eg. lamp, capacitive load), AgSnO₂ contact material is recommended on priority.

4) For gold plated type, the min. switching current and min. switching voltage is 10mA 5VDC.

5) The customer special requirement express as special code after evaluating by Hongfa.

OUTLINE DIMENSIONS, WIRING DIAGRAM AND PC BOARD LAYOUT

Unit: mm

Outline Dimensions

HF46F/□□-HS1□□ (XXX)

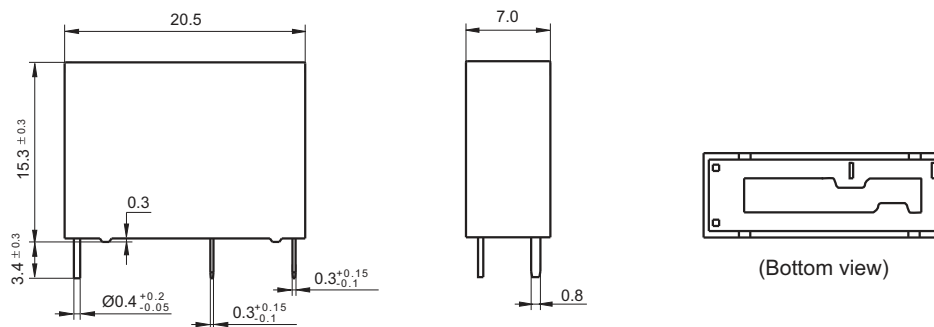

PCB Layout
(Bottom view)

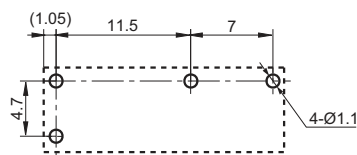

Wiring Diagram
(Bottom view)



OUTLINE DIMENSIONS, WIRING DIAGRAM AND PC BOARD LAYOUT

Unit: mm

- Remark: 1) In case of no tolerance shown in outline dimension: outline dimension $\leq 1\text{mm}$, tolerance should be $\pm 0.2\text{mm}$; outline dimension $> 1\text{mm}$ and $\leq 5\text{mm}$, tolerance should be $\pm 0.3\text{mm}$; outline dimension $> 5\text{mm}$, tolerance should be $\pm 0.4\text{mm}$.
 2) The tolerance without indicating for PCB layout is always $\pm 0.1\text{mm}$.

CHARACTERISTIC CURVES

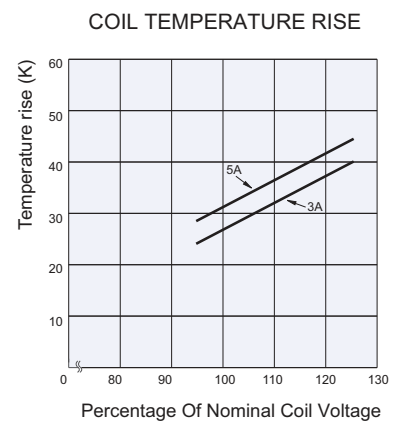
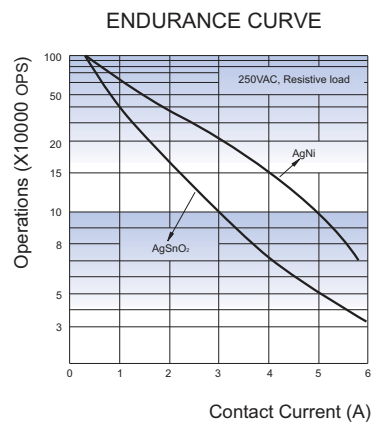
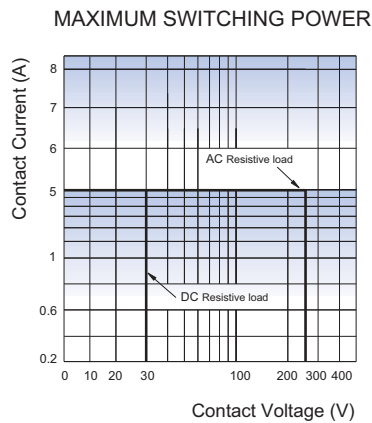

Test conditions:

- AgNi, at 85°C, 1s on 1s off,
- AgSnO₂, at 85°C, 3s on 3s off

Disclaimer

The specification is for reference only. See to "Terminology and Guidelines" for more information. Specifications subject to change without notice. We could not evaluate all the performance and all the parameters for every possible application. Thus the user should be in a right position to choose the suitable product for their own application. If there is any query, please contact Hongfa for the technical service. However, it is the user's responsibility to determine which product should be used only.

HF46F-G

SUBMINIATURE INTERMEDIATE POWER RELAY



File No.: E134517



File No.: 40025215



File No.: CQC08001024932



Features

- 10A switching capability
- 10kV impulse withstand voltage (between coil and contacts)
- Meets VDE 0631 reinforce insulation
- Highly efficient magnetic circuit for high sensitivity: 200mW
- Extremely small footprint utilizing PCB area
- UL insulation system: Class F available
- Environmental friendly product (RoHS compliant)
- Outline Dimensions: (20.5 x 7.2 x 15.3) mm

CONTACT DATA

Contact arrangement	1A
Contact resistance	100mΩ max.(at 1A 6VDC)
Contact material	AgSnO ₂ , AgNi
Contact rating (Res. load)	7A 250VAC / 30VDC
Max. switching voltage	277VAC / 30VDC
Max. switching current	10A
Max. switching power	2770VA / 300W
Mechanical endurance	5 x 10 ⁶ OPS
Electrical endurance	5 x 10 ⁴ OPS (7A 250VAC, Resistive load, AgNi, at 105°C, 3s on 3s off)
	6 x 10 ⁴ OPS (7A 250VAC, Resistive load, AgSnO ₂ , at 85°C, 3s on 3s off)
	1 x 10 ⁴ OPS (10A 250VAC, Resistive load, AgNi, at 85°C, 1s on 9s off)
	1 x 10 ⁴ OPS (10A 250VAC, Resistive load, AgSnO ₂ , at 85°C, 1s on 9s off)

CHARACTERISTICS

Insulation resistance	1000MΩ (at 500VDC)	
Dielectric strength	Between coil & contacts	4000VAC 1min
	Between open contacts	1000VAC 1min
Surge voltage (between coil & movable contacts)	10kV (1.2 / 50μs)	
Operate time (at nomi. volt.)	10ms max.	
Release time (at nomi. volt.)	10ms max.	
Shock resistance 1)	Functional	98m/s ²
	Destructive	980m/s ²
Vibration resistance 1)	10Hz to 55Hz 1.5mm DA	
Humidity	5% to 85% RH	
Ambient temperature	-40°C to 85°C	
Termination	PCB	
Unit weight	Approx. 3g	
Construction	Plastic sealed	

- Notes:** 1) Shock malfunction: 49m/s² for the length direction.
Vibration: 10Hz to 55Hz 1mm DA for the length direction.
2) The data shown above are initial values.
3) UL insulation system: Class F, Class B.

COIL

Coil power	Approx. 200mW
------------	---------------

COIL DATA

at 23°C

Nominal Voltage VDC	Pick-up Voltage VDC max.	Drop-out Voltage VDC min.	Max. Voltage VDC *	Coil Resistance Ω
3	2.25	0.18	3.90	45 x (1±10%)
5	3.75	0.25	6.50	125 x (1±10%)
6	4.50	0.30	7.80	180 x (1±10%)
9	6.75	0.45	11.7	405 x (1±10%)
12	9.00	0.60	15.6	720 x (1±10%)
18	13.5	0.90	23.4	1620 x (1±10%)
24	18.0	1.20	31.2	2880 x (1±10%)

Notes: * Maximum voltage refers to the maximum voltage which relay coil could endure in a short period of time.

SAFETY APPROVAL RATINGS

UL/CUL	AgNi	10A 125VAC/250VAC at 85°C 10A 277VAC/30VDC at 85°C 7A 125VAC/250VAC at 105°C 7A 277VAC/30VDC at 105°C
	AgSnO ₂	10A 125VAC/250VAC at 85°C 10A 277VAC/30VDC at 85°C 7A 125VAC/250VAC at 85°C 7A 277VAC/30VDC at 85°C TV-3
VDE	AgNi	7A 250VAC/30VDC at 105°C 10A 250VAC/30VDC at 85°C
	AgSnO ₂	7A 250VAC/30VDC at 85°C 10A 250VAC/30VDC at 85°C

- Notes:** 1) All values unspecified are at room temperature.
2) Only typical loads are listed above. Other load specifications can be available upon request.



HONGFA RELAY

ISO9001, ISO/TS16949, ISO14001, OHSAS18001, IECQ QC 080000 CERTIFIED

ORDERING INFORMATION

HF46F-G / 12 -H S 1 T G F (XXX)	
Type	
Coil voltage	3, 5, 6, 9, 12, 18, 24VDC
Contact arrangement	H: 1 Form A
Construction ¹⁾²⁾	S: Plastic sealed
Termination	1: type 1
Contact material ³⁾	T: AgSnO ₂ Nil: AgNi
Contact plating	G: Gold plated Nil: No gold plated
Insulation standard	F: Class F Nil: Class B
Special code ⁵⁾	XXX: Customer special requirement Nil: Standard

- Notes:** 1) We suggest to choose plastic sealed types and validate it in real application for an unclean environment (with contaminations like H₂S, SO₂, NO₂, dust, etc).
 2) Contact is recommended for suitable condition and specifications if water cleaning or surface process is involved in assembling relays on PCB.
 3) For the loads which can bring high inrush current when relay contacts connect instantly (eg. lamp, capacitive load), AgSnO₂ contact material is recommended on priority.
 4) For gold plated type, the min. switching current and min. switching voltage is 10mA 5VDC.
 5) The customer special requirement express as special code after evaluating by Hongfa.

OUTLINE DIMENSIONS, WIRING DIAGRAM AND PC BOARD LAYOUT

Unit: mm

Outline Dimensions

HF46F-G/□□-HS1□□(XXX)

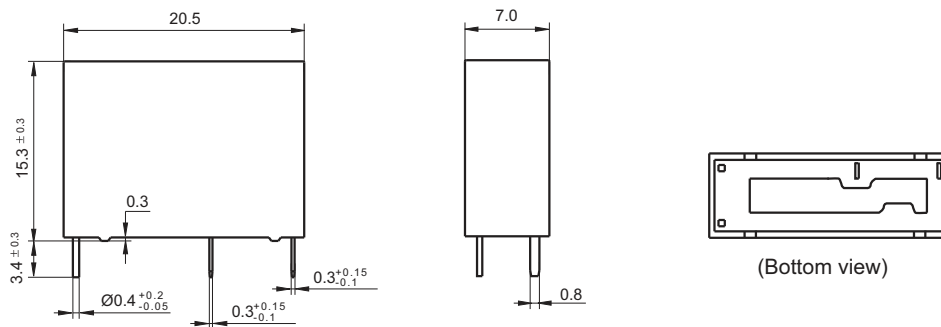

PCB Layout (Bottom view)

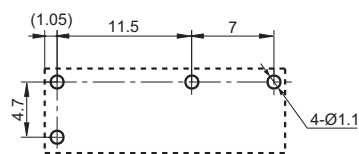

Wiring Diagram (Bottom view)

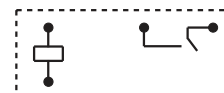

OUTLINE DIMENSIONS, WIRING DIAGRAM AND PC BOARD LAYOUT

Unit: mm

- Remark: 1) In case of no tolerance shown in outline dimension: outline dimension $\leq 1\text{mm}$, tolerance should be $\pm 0.2\text{mm}$; outline dimension $> 1\text{mm}$ and $\leq 5\text{mm}$, tolerance should be $\pm 0.3\text{mm}$; outline dimension $> 5\text{mm}$, tolerance should be $\pm 0.4\text{mm}$.
 2) The tolerance without indicating for PCB layout is always $\pm 0.1\text{mm}$.

CHARACTERISTIC CURVES

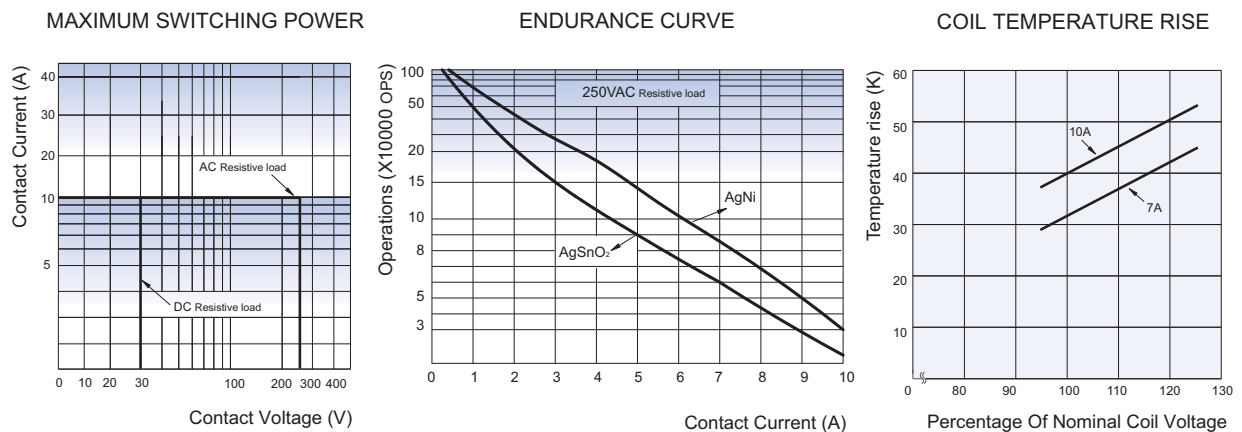

Test conditions: at 85°C, 3s on 3s off

Disclaimer

The specification is for reference only. See to "Terminology and Guidelines" for more information. Specifications subject to change without notice. We could not evaluate all the performance and all the parameters for every possible application. Thus the user should be in a right position to choose the suitable product for their own application. If there is any query, please contact Hongfa for the technical service. However, it is the user's responsibility to determine which product should be used only.

© Xiamen Hongfa Electroacoustic Co., Ltd. All rights of Hongfa are reserved.

HF42F

SUBMINIATURE INTERMEDIATE POWER RELAY



File No.:E133481



File No.:R50356443



File No.:CQC09002034521



Features

- 5A switching capability
- TV-3 125VAC approved by UL standard
- 2 Form A slim configuration
- Environmental friendly product (RoHS compliant)
- Outline Dimensions: (24.4 x 12.8 x 24.8) mm

CONTACT DATA

Contact arrangement	2A
Contact resistance	100mΩ max. (at 1A 6VDC)
Contact material	AgSnO ₂ , AgCdO
Contact rating (Res. load)	5A 250VAC/30VDC
Max. switching voltage	250VAC / 30VDC
Max. switching current	5A
Max. switching power	1250VA / 150W
Mechanical endurance	1 x 10 ⁷ OPS
Electrical endurance	5 x 10 ⁴ OPS (5A 250VAC, Resistive load, Room temp., 1s on 9s off)

CHARACTERISTICS

Insulation resistance	1000MΩ (at 500VDC)	
Dielectric strength	Between coil & contacts	4000VAC 1min
	Between open contacts	1000VAC 1min
	Between contact sets	2000VAC 1min
Operate time (at nomi. volt.)	15ms max.	
Release time (at nomi. volt.)	10ms max.	
Humidity	5% to 85% RH	
Ambient temperature	-40°C to 70°C	
Shock resistance	Functional	98m/s ²
	Destructive	980m/s ²
Vibration resistance	10Hz to 55Hz 1.5mm DA	
Termination	PCB	
Unit weight	Approx. 14.5g	
Construction	Plastic sealed	

- Notes:** 1) The data shown above are initial values.
2) Please find coil temperature curve in the characteristic curves below.
3) UL insulation system: Class A

COIL

Coil power	Approx. 530mW
------------	---------------

COIL DATA

at 23°C

Nominal Voltage VDC	Pick-up Voltage VDC max.	Drop-out Voltage VDC min.	Max. Voltage VDC *	Coil Resistance Ω
5	3.75	0.25	6.5	47 x (1±10%)
6	4.50	0.30	7.8	68 x (1±10%)
9	6.75	0.45	11.7	155 x (1±10%)
12	9.00	0.60	15.6	270 x (1±10%)
18	13.5	0.90	23.4	620 x (1±10%)
24	18.0	1.20	31.2	1080 x (1±10%)
48	36.0	2.40	62.4	4400 x (1±10%)

Notes: *Maximum voltage refers to the maximum voltage which relay coil could endure in a short period of time.

SAFETY APPROVAL RATINGS

UL/CUL	5A 250VAC 5A 30VDC TV-3 125VAC
TÜV	5A 250VAC 5A 30VDC

- Notes:** 1) All values unspecified are at room temperature.
2) Only typical loads are listed above. Other load specifications can be available upon request.



HONGFA RELAY

ISO9001, ISO/TS16949, ISO14001, OHSAS18001, IECQ QC 080000 CERTIFIED

ORDERING INFORMATION

Type	HF42F / 012 -2H S T (XXX)
Coil voltage	5, 6, 9, 12, 18, 24, 48VDC
Contact arrangement	2H: 2 Form A
Construction ¹⁾	S: Plastic sealed
Contact material	T: AgSnO ₂ Nil: AgCdO
Special code ²⁾	XXX: Customer special requirement Nil: Standard

Notes: 1) Contact is recommended for suitable condition and specifications if water cleaning or surface process is involved in assembling relays on PCB.

2) The customer special requirement express as special code after evaluating by Hongfa.

OUTLINE DIMENSIONS, WIRING DIAGRAM AND PC BOARD LAYOUT

Unit: mm

Outline Dimensions

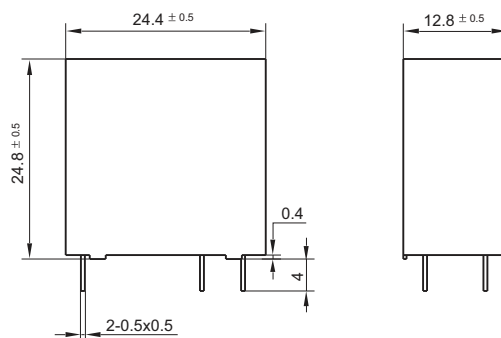

Wiring Diagram
(Bottom view)



PCB Layout
(Bottom view)

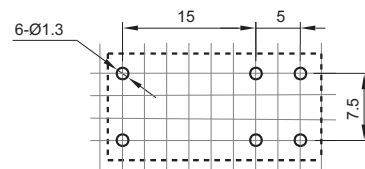

Remark: 1) In case of no tolerance shown in outline dimension: outline dimension ≤ 1 mm, tolerance should be ± 0.2 mm; outline dimension > 1 mm and ≤ 5 mm, tolerance should be ± 0.3 mm; outline dimension > 5 mm, tolerance should be ± 0.4 mm.

2) The tolerance without indicating for PCB layout is always ± 0.1 mm.

3) The width of the gridding is 2.5mm.

CHARACTERISTIC CURVES

MAXIMUM SWITCHING POWER

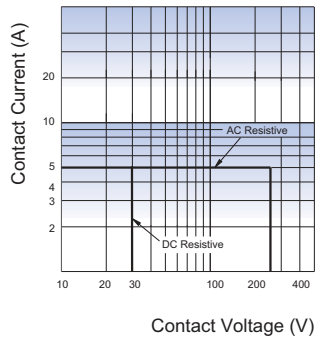

ENDURANCE CURVE

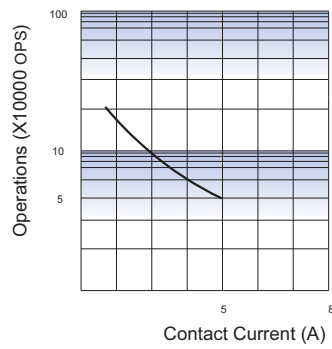

Test conditions:
5A 250VAC, Resistive load,
Room temp., 1s on 9s off

COIL TEMPERATURE RISE

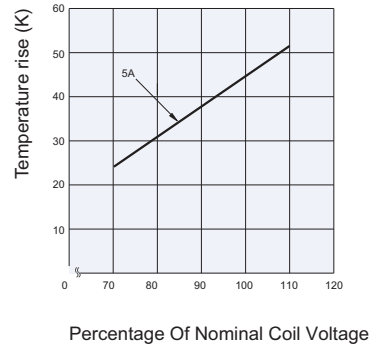

Disclaimer

The specification is for reference only. See to "Terminology and Guidelines" for more information. Specifications subject to change without notice. We could not evaluate all the performance and all the parameters for every possible application. Thus the user should be in a right position to choose the suitable product for their own application. If there is any query, please contact Hongfa for the technical service. However, it is the user's responsibility to determine which product should be used only.

HF32FA

SUBMINIATURE INTERMEDIATE POWER RELAY



File No.:E134517



File No.:40006182



File No.:CQC09002028689



Features

- 5A switching capability
- Creepage/clearance distance > 8mm
- 5kV dielectric strength (between coil and contacts)
- 1 Form A meets VDE 0700, 0631 reinforce insulation
- 1 Form C meets VDE 0631 reinforce insulation
- UL insulation system: Class F
- Product in accordance to IEC 60335-1 available
- Environmental friendly product (RoHS compliant)
- Outline Dimensions: (17.6 x 10.1 x 12.3) mm

CONTACT DATA

Contact arrangement	1A, 1C	
Contact resistance	70mΩ max.(at 1A 6VDC)	
Contact material	AgNi	
Contact rating (Res. Load)	1A	1C
	Standard/Sensitive	Standard
	5A 250VAC 5A 30VDC	3A 250VAC 3A 30VDC
Max. switching voltage	250VAC / 30VDC	
Max. switching current	5A	
Max. switching power	1250VA / 150W	
Mechanical endurance	1 x 10 ⁶ OPS	
Electrical endurance	H type: 1 x 10 ⁵ OPS (5A 250VAC, Resistive load, Room temp., 1.5s on 1.5s off)	
	Z type: 1 x 10 ⁵ OPS (NO/NC, 3A 250VAC, Resistive load, Room temp., 1.5s on 1.5s off)	

CHARACTERISTICS

Insulation resistance	1000MΩ (at 500VDC)	
Dielectric strength	Between coil & contacts	5000VAC 1min
	Between open contacts	1000VAC 1min
Operate time (at nomi. volt.)	8ms max.	
Release time (at nomi. volt.)	4ms max.	
Humidity	5% to 85% RH	
Ambient temperature	-40°C to 85°C	
Shock resistance*	Functional	98m/s ²
	Destructive	980m/s ²
Vibration resistance*	NO	10Hz to 55 Hz 1.65mm DA
	NC	10Hz to 55 Hz 0.6mm DA
Termination	PCB	
Unit weight	Approx.4.6g	
Construction	Plastic sealed, Flux proofed	

- Notes:** 1) *Index is not in relay length direction.
 2) The data shown above are initial values.
 3) Please find coil temperature curve in the characteristic curves below.

COIL

Coil power	Sensitive: Approx. 200mW; Standard: Approx. 450mW
------------	--

COIL DATA

at 23°C

Standard type

Nominal Voltage VDC	Pick-up Voltage VDC max.	Drop-out Voltage VDC min.	Max. Voltage VDC ¹⁾	Coil Resistance Ω
3	2.25	0.15	3.9	20 x (1±10%)
5	3.75	0.25	6.5	55 x (1±10%)
6	4.50	0.30	7.8	80 x (1±10%)
9	6.75	0.45	11.7	180 x (1±10%)
12	9.00	0.60	15.6	320 x (1±10%)
18	13.5	0.90	23.4	720 x (1±10%)
24	18.0	1.20	31.2	1280 x (1±10%)
48 ²⁾	36.0	2.40	62.4	5120 x (1±10%)

Sensitive type (Only for 1 Form A)

Nominal Voltage VDC	Pick-up Voltage VDC max.	Drop-out Voltage VDC min.	Max. Voltage VDC ¹⁾	Coil Resistance Ω
3	2.25	0.15	5.1	45 x (1±10%)
5	3.75	0.25	8.5	125 x (1±10%)
6	4.50	0.30	10.2	180 x (1±10%)
9	6.75	0.45	15.3	400 x (1±10%)
12	9.00	0.60	20.4	720 x (1±10%)
18	13.5	0.90	30.6	1600 x (1±10%)
24	18.0	1.20	40.8	2800 x (1±10%)

- Notes:** 1) Maximum voltage refers to the maximum voltage which relay coil could endure in a short period of time.
 2) For products with rated voltage ≥ 48V, measures should be taken to prevent coil overvoltage in order to protect coil in test and application (eg. Connect diodes in parallel).

SAFETY APPROVAL RATINGS

UL/CUL	1 Form A	5A 250VAC 5A 30VDC 1/8HP 125VAC/250VAC TV-2 C300
	1 Form C	3A 250VAC 3A 30VDC
VDE		5A 250VAC at 85°C 2A 250VAC cosφ=0.5 at 85°C 1 Form A, Sensitive: 3A 400VAC at 85°C

- Notes:** 1) All values unspecified are at room temperature.
 2) Only typical loads are listed above. Other load specifications can be available upon request.



HONGFA RELAY

ISO9001, ISO/TS16949, ISO14001, OHSAS18001, IECQ QC 080000 CERTIFIED

ORDERING INFORMATION

HF32FA / 012 -H S L 1 G (XXX)	
Type	
Coil voltage	3, 5, 6, 9, 12, 18, 24, 48VDC
Contact arrangement	H: 1 Form A Z: 1 Form C
Construction¹⁾²⁾	S: Plastic sealed Nil: Flux proofed
Coil power	L: Sensitive (Only for 1 Form A) Nil: Standard
Termination	1: Type 1 2: Type 2
Contact plating³⁾	G: Gold plated Nil: No gold plated
Special code⁴⁾	XXX: Customer special requirement Nil: Standard

- Notes:** 1) We recommend flux proofed types for a clean environment (free from contaminations like H₂S, SO₂, NO₂, dust, etc.). We suggest to choose plastic sealed types and validate it in real application for an unclean environment (with contaminations like H₂S, SO₂, NO₂, dust, etc).
- 2) Contact is recommended for suitable condition and specifications if water cleaning or surface process is involved in assembling relays on PCB.
- 3) For gold plated type, the min. switching current and min. switching voltage is 10mA 5VDC.
- 4) The customer special requirement express as special code after evaluating by Hongfa. e.g.(335) stands for product in accordance to IEC 60335-1 (GWT).

OUTLINE DIMENSIONS, WIRING DIAGRAM AND PC BOARD LAYOUT

Unit: mm

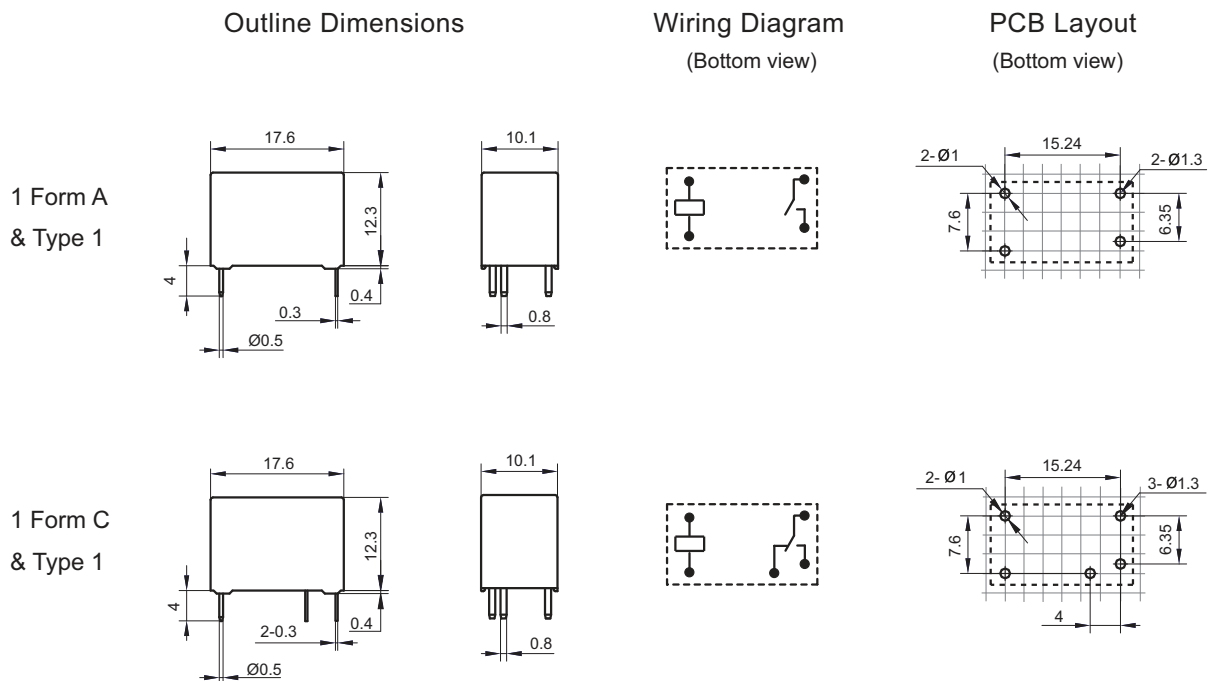

OUTLINE DIMENSIONS, WIRING DIAGRAM AND PC BOARD LAYOUT

Unit: mm

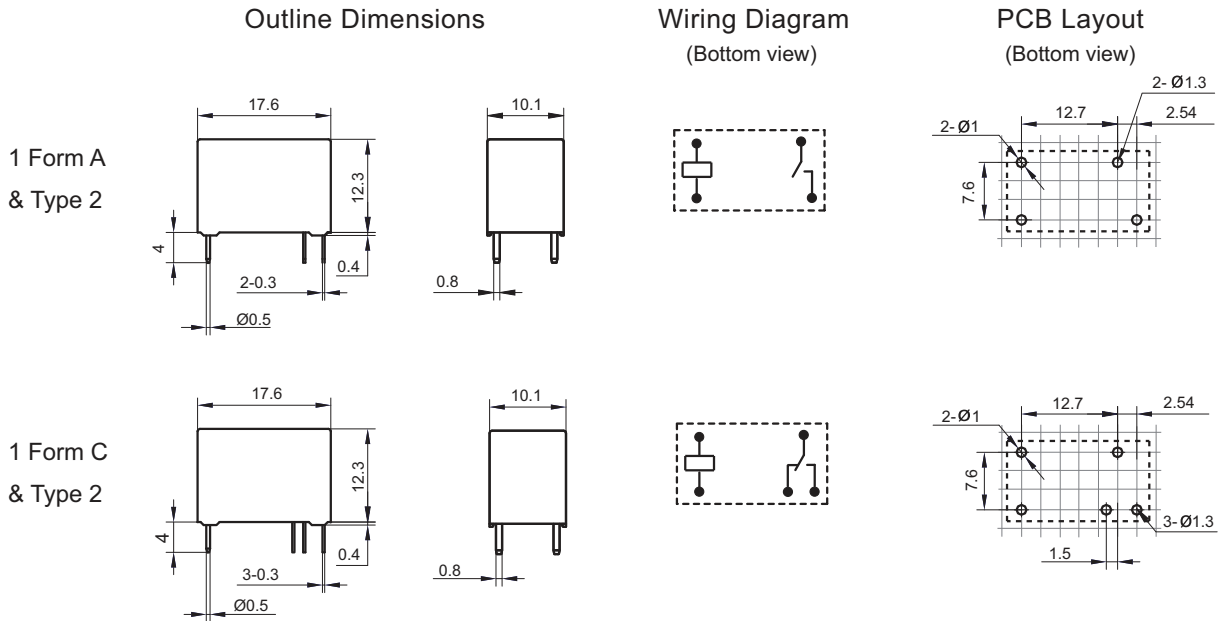

Remark: 1) In case of no tolerance shown in outline dimension: outline dimension ≤ 1 mm, tolerance should be ± 0.2 mm; outline dimension > 1 mm and ≤ 5 mm, tolerance should be ± 0.3 mm; outline dimension > 5 mm, tolerance should be ± 0.4 mm.
 2) The tolerance without indicating for PCB layout is always ± 0.1 mm.
 3) The width of the gridding is 2.54mm.

CHARACTERISTIC CURVES

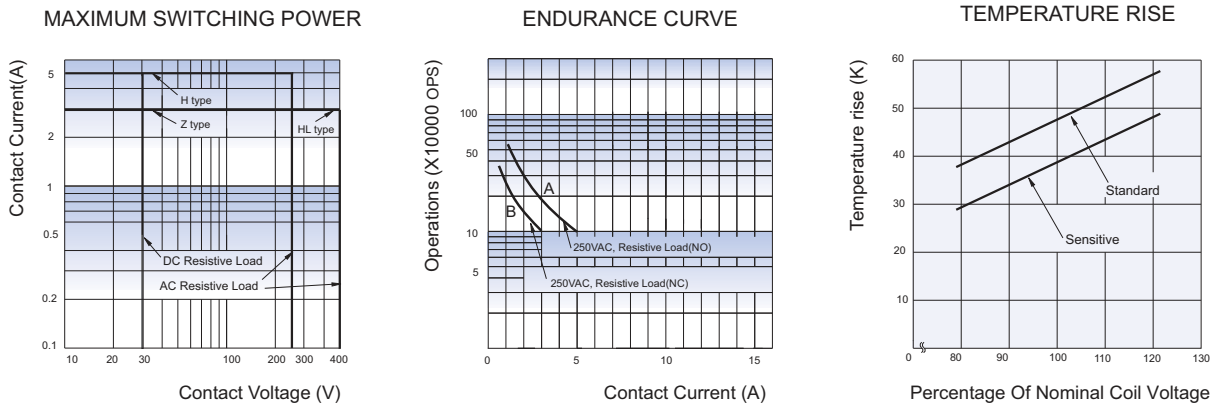

Notes:
 1) Curve A: H type,
 Curve B: Z type
 2) Test conditions: Flux proofed,
 Room temp., 1.5s on 1.5s off.

Disclaimer

The specification is for reference only. See to "Terminology and Guidelines" for more information. Specifications subject to change without notice. We could not evaluate all the performance and all the parameters for every possible application. Thus the user should be in a right position to choose the suitable product for their own application. If there is any query, please contact Hongfa for the technical service. However, it is the user's responsibility to determine which product should be used only.

HF32FA-T

SUBMINIATURE INTERMEDIATE HIGH TEMPERATURE POWER RELAY



File No.:E134517



File No.:40006182



File No.:CQC09002028689



Features

- High temperature: 105°C
- 5A switching capability
- 1 Form A configuration
- Creepage/clearance distance>8mm
- 5kV dielectric strength (between coil and contacts)
- UL insulation system: Class F
- Meeting VDE 0700, 0631 reinforce insulation
- Product in accordance to IEC 60335-1 available
- Environmental friendly product (RoHS compliant)
- Outline Dimensions: (17.6 x 10.1 x 12.3) mm

CONTACT DATA

Contact arrangement	1A
Contact resistance	70mΩ max.(at 1A 6VDC)
Contact material	AgNi
Contact rating (Res. load)	5A 250VAC 5A 30VDC
Max. switching voltage	250VAC/30VDC
Max. switching current	5A
Max. switching power	1250VA/150W
Mechanical endurance	1 x 10 ⁶ OPS
Electrical endurance	1 x 10 ⁵ OPS (5A 250VAC, Resistive load, Room temp., 1.5s on 1.5s off)

CHARACTERISTICS

Insulation resistance	1000MΩ (at 500VDC)	
Dielectric strength	Between coil & contacts	5000VAC 1min
	Between open contacts	1000VAC 1min
Operate time (at nomi. volt.)	8ms max.	
Release time (at nomi. volt.)	4ms max.	
Humidity	5% to 85% RH	
Ambient temperature	-40°C to 105°C	
Shock resistance*	Functional	98m/s ²
	Destructive	980m/s ²
Vibration resistance*	10Hz to 55Hz 1.65mm DA	
Termination	PCB	
Unit weight	Approx.4.6g	
Construction	Plastic sealed, Flux proofed	

- Notes:** 1) *Index is not in relay length direction.
2) The data shown above are initial values.
3) Please find coil temperature curve in the characteristic curves below.

COIL

Coil power	Sensitive: Approx. 200mW
------------	--------------------------

COIL DATA

at 23°C

Sensitive type

Nominal Voltage VDC	Pick-up Voltage VDC max.	Drop-out Voltage VDC min.	Max. Voltage VDC *	Coil Resistance Ω
3	2.25	0.15	5.1	45 x (1±10%)
5	3.75	0.25	8.5	125 x (1±10%)
6	4.50	0.30	10.2	180 x (1±10%)
9	6.75	0.45	15.3	400 x (1±10%)
12	9.00	0.60	20.4	720 x (1±10%)
18	13.5	0.90	30.6	1600 x (1±10%)
24	18.0	1.20	40.8	2800 x (1±10%)

Notes: * Maximum voltage refers to the maximum voltage which relay coil could endure in a short period of time.

SAFETY APPROVAL RATINGS

UL/CUL	5A 250VAC
VDE	5A 250VAC at 105°C 3A 400VAC at 105°C

- Notes:** 1) All values unspecified are at room temperature.
2) Only typical loads are listed above. Other load specifications can be available upon request.



HONGFA RELAY

ISO9001, ISO/TS16949, ISO14001, OHSAS18001, IECQ QC 080000 CERTIFIED

ORDERING INFORMATION

Type	HF32FA-T / 012 -H S L 1 G (XXX)					
Coil voltage	3, 5, 6, 9, 12, 18, 24VDC					
Contact arrangement	H: 1 Form A					
Construction ¹⁾²⁾	S: Plastic sealed		Nil: Flux proofed			
Coil power	L: Sensitive					
Termination	1: Type 1		2: Type 2			
Contact plating ³⁾	G: Gold plated		Nil: No gold plated			
Special code ⁴⁾	XXX: Customer special requirement		Nil: Standard			

- Notes:** 1) We recommend flux proofed types for a clean environment (free from contaminations like H₂S, SO₂, NO₂, dust, etc.). We suggest to choose plastic sealed types and validate it in real application for an unclean environment (with contaminations like H₂S, SO₂, NO₂, dust, etc).
- 2) Contact is recommended for suitable condition and specifications if water cleaning or surface process is involved in assembling relays on PCB.
- 3) For gold plated type, the min. switching current and min. switching voltage is 10mA 5VDC.
- 4) The customer special requirement express as special code after evaluating by Hongfa. e.g.(335) stands for product in accordance to IEC 60335-1 (GWT).

OUTLINE DIMENSIONS, WIRING DIAGRAM AND PC BOARD LAYOUT

Unit: mm

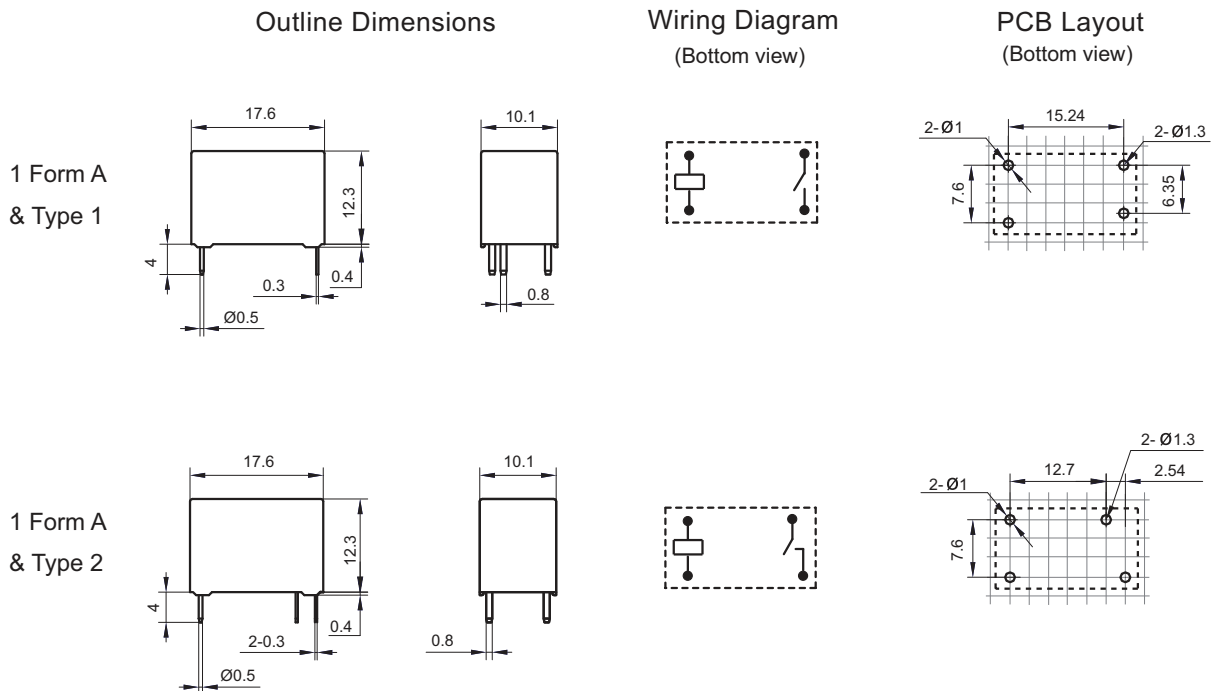

- Remark: 1) In case of no tolerance shown in outline dimension: outline dimension ≤ 1 mm, tolerance should be ± 0.2 mm; outline dimension > 1 mm and ≤ 5 mm, tolerance should be ± 0.3 mm; outline dimension > 5 mm, tolerance should be ± 0.4 mm.
- 2) The tolerance without indicating for PCB layout is always ± 0.1 mm.
- 3) The width of the gridding is 2.54mm.

CHARACTERISTIC CURVES

MAXIMUM SWITCHING POWER

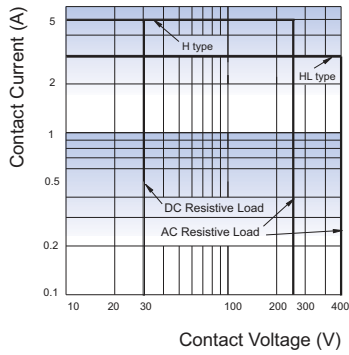

ENDURANCE CURVE

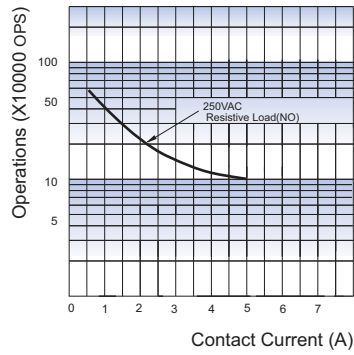

Test conditions: Flux proofed,
Room temp., 1.5s on 1.5s off

TEMPERATURE RISE

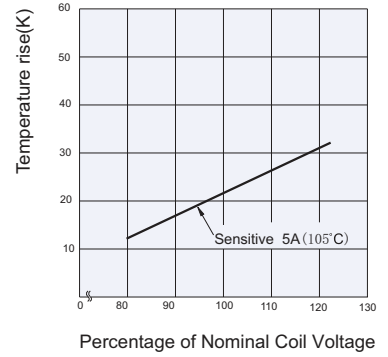

Disclaimer

The specification is for reference only. See to "Terminology and Guidelines" for more information. Specifications subject to change without notice. We could not evaluate all the performance and all the parameters for every possible application. Thus the user should be in a right position to choose the suitable product for their own application. If there is any query, please contact Hongfa for the technical service. However, it is the user's responsibility to determine which product should be used only.

HF32FA-G

SUBMINIATURE INTERMEDIATE POWER RELAY



File No.:E134517



File No.:40006182



File No.:CQC09002028689



Features

- 10A switching capability
- Creepage/clearance distance > 8mm
- 5kV dielectric strength (between coil and contacts)
- UL insulation system: Class F
- Meets VDE 0700, 0631 reinforce insulation
- Product in accordance to IEC 60335-1 available
- Environmental friendly product (RoHS compliant)
- Outline Dimensions: (17.6 x 10.1 x 12.3) mm

CONTACT DATA

Contact arrangement	1A
Contact resistance	70mΩ max.(at 1A 6VDC)
Contact material	AgSnO ₂
Contact rating (Res. Load)	10A 250VAC
Max. switching voltage	250VAC
Max. switching current	10A
Max. switching power	2500VA
Mechanical endurance	1 x 10 ⁶ OPS
Electrical endurance	1 x 10 ⁴ OPS (10A 250VAC, Resistive load, at 85°C, 1s on 9s off)

CHARACTERISTICS

Insulation resistance	1000MΩ (at 500VDC)	
Dielectric strength	Between coil & contacts	5000VAC 1min
	Between open contacts	1000VAC 1min
Operate time (at nomi. volt.)	8ms max.	
Release time (at nomi. volt.)	4ms max.	
Humidity	5% to 85% RH	
Ambient temperature	-40°C to 85°C	
Shock resistance*	Functional	98m/s ²
	Destructive	980m/s ²
Vibration resistance*	10Hz to 55 Hz 1.65mm DA	
Termination	PCB	
Unit weight	Approx.4.6g	
Construction	Plastic sealed, Flux proofed	

- Notes:** 1) *Index is not in relay length direction.
 2) The data shown above are initial values.
 3) Please find coil temperature curve in the characteristic curves below.

COIL

Coil power	Standard: Approx. 450mW; Sensitive: Approx. 230mW
------------	--

COIL DATA

at 23°C

Standard type

Nominal Voltage VDC	Pick-up Voltage VDC max.	Drop-out Voltage VDC min.	Max. Voltage VDC ¹⁾	Coil Resistance Ω
3	2.25	0.15	3.9	20 x (1±10%)
5	3.75	0.25	6.5	55 x (1±10%)
6	4.50	0.30	7.8	80 x (1±10%)
9	6.75	0.45	11.7	180 x (1±10%)
12	9.00	0.60	15.6	320 x (1±10%)
18	13.5	0.90	23.4	720 x (1±10%)
24	18.0	1.20	31.2	1280 x (1±10%)
48 ²⁾	36.0	2.40	62.4	5120 x (1±10%)

Sensitive type

Nominal Voltage VDC	Pick-up Voltage VDC max.	Drop-out Voltage VDC min.	Max. Voltage VDC ¹⁾	Coil Resistance Ω
3	2.25	0.15	5.1	38 x (1±10%)
5	3.75	0.25	8.5	108 x (1±10%)
6	4.50	0.30	10.2	155 x (1±10%)
9	6.75	0.45	15.3	350 x (1±10%)
12	9.00	0.60	20.4	620 x (1±10%)
18	13.5	0.90	30.6	1390 x (1±10%)
24	18.0	1.20	40.8	2480 x (1±10%)
48 ²⁾	36.0	2.40	81.6	9920 x (1±10%)

- Notes:** 1) Maximum voltage refers to the maximum voltage which relay coil could endure in a short period of time.
 2) For products with rated voltage ≥ 48V, measures should be taken to prevent coil overvoltage in order to protect coil in test and application (eg. Connect diodes in parallel).

SAFETY APPROVAL RATINGS

UL/CUL	10A 250VAC at 85°C B300
VDE	10A 250VAC at 85°C

- Notes:** 1) All values unspecified are at room temperature.
 2) Only typical loads are listed above. Other load specifications can be available upon request.



HONGFA RELAY

ISO9001, ISO/TS16949, ISO14001, OHSAS18001, IECQ QC 080000 CERTIFIED

ORDERING INFORMATION

Type		HF32FA-G / 012 -H S L 1 G (XXX)	
Coil voltage	3, 5, 6, 9, 12, 18, 24, 48VDC		
Contact arrangement	H: 1 Form A		
Construction ¹⁾²⁾	S: Plastic sealed	Nil: Flux proofed	
Coil power	L: Sensitive	Nil: Standard	
Termination	1: Type 1	2: Type 2	
Contact plating ³⁾	G: Gold plated	Nil: No gold plated	
Special code ⁴⁾	XXX: Customer special requirement	Nil: Standard	

- Notes:** 1) We recommend flux proofed types for a clean environment (free from contaminations like H₂S, SO₂, NO₂, dust, etc.). We suggest to choose plastic sealed types and validate it in real application for an unclean environment (with contaminations like H₂S, SO₂, NO₂, dust, etc).
- 2) Contact is recommended for suitable condition and specifications if water cleaning or surface process is involved in assembling relays on PCB.
- 3) For gold plated type, the min. switching current and min. switching voltage is 10mA 5VDC.
- 4) The customer special requirement express as special code after evaluating by Hongfa. e.g.(335) stands for product in accordance to IEC 60335-1 (GWT).

OUTLINE DIMENSIONS, WIRING DIAGRAM AND PC BOARD LAYOUT

Unit: mm

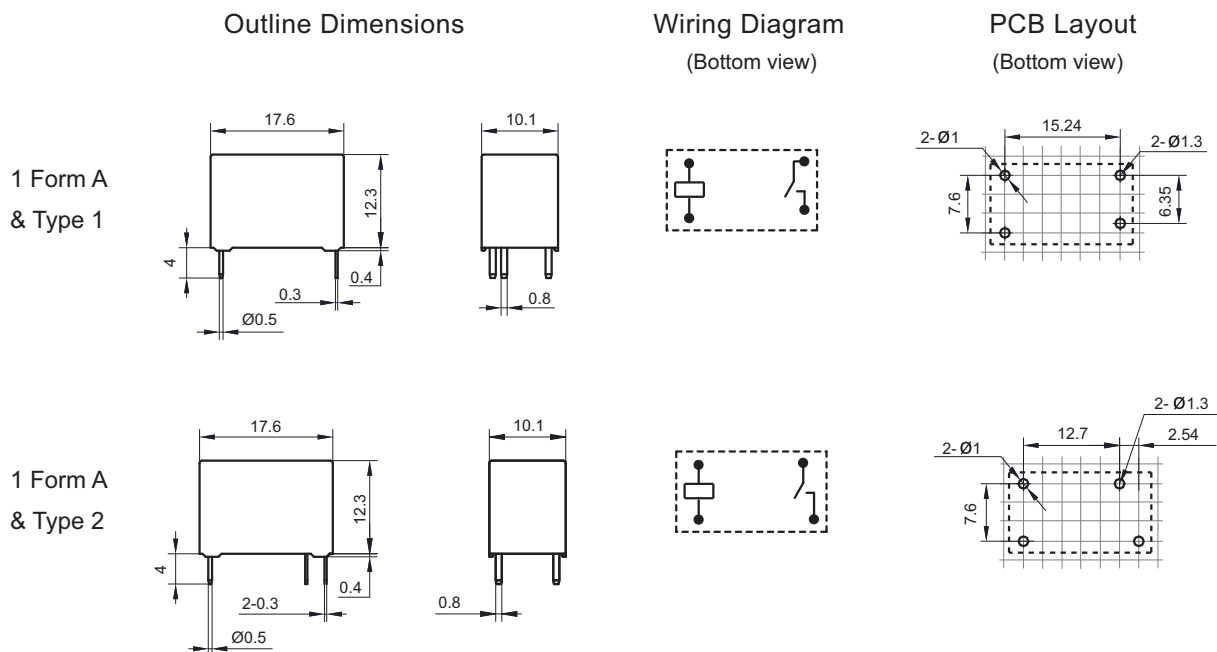

- Remark: 1) In case of no tolerance shown in outline dimension: outline dimension ≤ 1 mm, tolerance should be ± 0.2 mm; outline dimension ≤ 5 mm, tolerance should be ± 0.3 mm; outline dimension > 5 mm, tolerance should be ± 0.4 mm.
- 2) The tolerance without indicating for PCB layout is always ± 0.1 mm.
- 3) The width of the gridding is 2.54mm.

CHARACTERISTIC CURVES

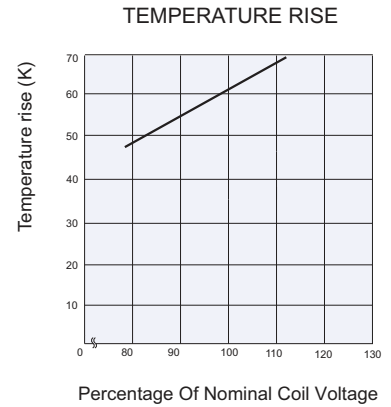
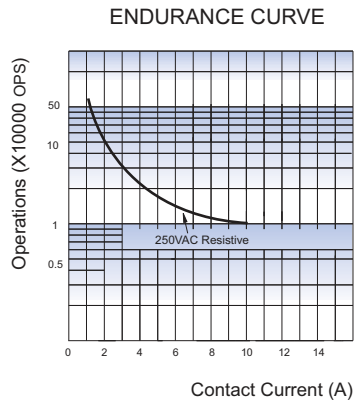
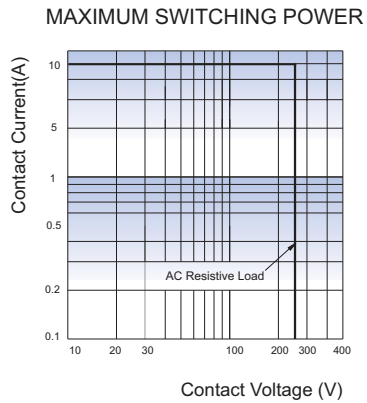

Test conditions: Flux proofed, at 85°C
5s on 5s off

Disclaimer

The specification is for reference only. See to "Terminology and Guidelines" for more information. Specifications subject to change without notice. We could not evaluate all the performance and all the parameters for every possible application. Thus the user should be in a right position to choose the suitable product for their own application. If there is any query, please contact Hongfa for the technical service. However, it is the user's responsibility to determine which product should be used only.

HF32FV

SUBMINIATURE INTERMEDIATE POWER RELAY



File No.:E134517



File No.:40012204



File No.:CQC14002120720



Features

- 5A switching capability
- Creepage distance: 6.5mm (between coil & contacts)
- Dielectric strength 4kV (between coil and contacts)
- 1 Form A configurations
- Standard PCB layout
- Plastic sealed and flux proofed types available
- Product in accordance to IEC 60335-1 available
- UL insulation system: Class F
- Environmental friendly product (RoHS compliant)
- Outline Dimensions: (18.4 x 10.2 x 15.3) mm

CONTACT DATA

Contact arrangement	1A	
Contact resistance	100mΩ max.(at 1A 6VDC)	
Contact material	AgSnO ₂ , AgCdO, AgNi	
Contact rating (Res. load)	Standard	Sensitive
	5A 250VAC 5A 30VDC	3A 250VAC 3A 30VDC
Max. switching voltage	277VAC / 30VDC	
Max. switching current	5A	3A
Max. switching power	1250VA / 150W	750VA / 90W
Mechanical endurance	1 x 10 ⁷ OPS	
Electrical endurance	Standard	1 x 10 ⁵ OPS (5A 250VAC Resistive load, at room temp., 1s on 9s off) 5 x 10 ⁴ OPS (5A 250VAC Resistive load, at 85°C, 1s on 9s off)
	Sensitive	1 x 10 ⁵ OPS (3A 250VAC Resistive load, at room temp., 1s on 9s off) 5 x 10 ⁴ OPS (3A 250VAC Resistive load, at 85°C, 1s on 9s off)

CHARACTERISTICS

Insulation resistance	1000MΩ (at 500VDC)	
Dielectric strength	Between coil & contacts	4000VAC 1min
	Between open contacts	1000VAC 1min
Surge withstand voltage	6kV(1.2 / 50μs)	
Operate time (at nomi. volt.)	8ms max.	
Release time (at nomi. volt.)	5ms max.	
Coil temperature rise(at nomi. volt.)	60k max.	
Shock * resistance	Functional	98m/s ²
	Destructive	980m/s ²
Vibration resistance *	Functional	10Hz to 55Hz 1.5mm DA
Humidity	5% to 85% RH	
Ambient temperature	-40°C to 85°C	
Termination	PCB	
Unit weight	Approx. 6g	
Construction	Plastic sealed, Flux proofed	

Notes: 1) The data shown above are initial values.

2) *Index is not in relay length direction.

3) In order to obtain better electrical endurance, it's better not use this product in the high temperature environment.

COIL

Coil power	Standard: Approx. 450mW; Sensitive: Approx. 200mW
------------	--

COIL DATA

at 23°C

Standard Type

Nominal Voltage VDC	Pick-up Voltage VDC max.	Drop-out Voltage VDC min.	Max. Voltage VDC *	Coil Resistance Ω
3	2.25	0.15	3.9	20 x (1±10%)
5	3.75	0.25	6.5	55 x (1±10%)
6	4.50	0.30	7.8	80 x (1±10%)
9	6.75	0.45	11.7	180 x (1±10%)
12	9.00	0.60	15.6	320 x (1±10%)
18	13.5	0.90	23.4	720 x (1±10%)
24	18.0	1.20	31.2	1280 x (1±10%)
48	36.0	2.40	62.4	5120 x (1±10%)

Sensitive Type

Nominal Voltage VDC	Pick-up Voltage VDC max.	Drop-out Voltage VDC min.	Max. Voltage VDC *	Coil Resistance Ω
3	2.25	0.15	4.5	45 x (1±10%)
5	3.75	0.25	7.5	125 x (1±10%)
6	4.50	0.30	9.0	180 x (1±10%)
9	6.75	0.45	13.5	400 x (1±10%)
12	9.00	0.60	18.0	720 x (1±10%)
18	13.5	0.90	27.0	1600 x (1±10%)
24	18.0	1.20	36.0	2800 x (1±10%)
48	36.0	2.40	72.0	11520 x (1±10%)

Notes: * Maximum voltage refers to the maximum voltage which relay coil could endure in a short period of time.



HONGFA RELAY

ISO9001, ISO/TS16949, ISO14001, OHSAS18001, IECQ QC 080000 CERTIFIED

SAFETY APPROVAL RATINGS

UL/CUL	AgSnO ₂	5A 277VAC /250VAC General Use at 40°C 5A 277VAC/250VAC General Use at 85°C 5A 30VDC Resistive at 85°C 300W 120VAC Tunsten at 40°C 1/4HP 250VAC at 85°C 3A 277VAC/250VAC General Use (Sensitive) at 85°C 3A 30VDC Resistive (Sensitive) at 85°C TV-3 120VAC at 40°C
	AgCdO	5A 277VAC/250VAC General Use at 85°C 5A 30VDC Resistive at 85°C
VDE	AgSnO ₂	250VAC 4(2) Inductive load at 85°C 5A 30VDC Resistive at 85°C 5A 277VAC/250VAC Resistive at 85°C 3A 277VAC/250VAC Resistive at 85°C 3A 30VDC Resistive (Sensitive) at 85°C
	AgCdO	5A 277VAC/250VAC Resistive at 85°C 5A 30VDC Resistive at 85°C
CQC	AgSnO ₂	5A 277VAC/250VAC Resistive at 85°C 5A 30VDC Resistive at 85°C
	AgCdO	3A 277VAC/250VAC Resistive (Sensitive) at 85°C 5A 277VAC/250VAC Resistive at 85°C 5A 30VDC Resistive at 85°C

Notes: 1) All values unspecified are at room temperature.

2) Only typical loads are listed above. Other load specifications can be available upon request.

ORDERING INFORMATION

HF32FV / 12 -H S L T F G (XXX)	
Type	
Coil voltage	3, 5, 6, 9, 12, 18, 24, 48VDC
Contact arrangement	H: 1 Form A
Construction ¹⁾²⁾	S: Plastic sealed Nil: Flux proofed
Coil power	L: Sensitive ³⁾ Nil: Standard
Contact material	T: AgSnO ₂ Nil: AgCdO 3: AgNi
Insulation standard	F: Class F
Contact plating ⁴⁾	G: Gold plated Nil: No gold plated
Customer special code ⁵⁾	XXX: Customer special requirement Nil: Standard

Notes: 1) We recommend flux proofed types for a clean environment (free from contaminations like H₂S, SO₂, NO₂, dust, etc.).

2) Contact is recommended for suitable condition and specifications if water cleaning or surface process is involved in assembling relays on PCB.

3) Sensitive loading: 3A.

4) For gold plated type, the min. switching current and min. switching voltage is 10mA 5VDC.

5) The customer special requirement express as special code after evaluating by Hongfa. e.g.(335) stands for product in accordance to IEC 60335-1 (GWT); e.g.(590) stands for product in accordance to TV-3 loading.

OUTLINE DIMENSIONS, WIRING DIAGRAM AND PC BOARD LAYOUT

Unit: mm

Outline Dimensions

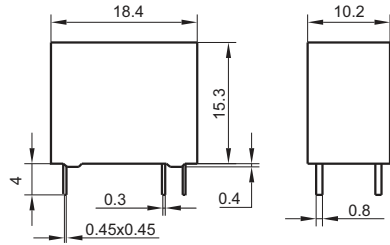

Wiring Diagram
(Bottom view)

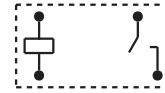

(Bottom view)

PCB Layout
(Bottom view)

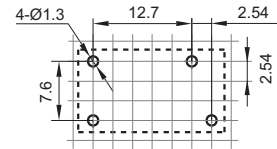

- Remark: 1) In case of no tolerance shown in outline dimension: outline dimension $\leq 1\text{mm}$, tolerance should be $\pm 0.2\text{mm}$; outline dimension $> 1\text{mm}$ and $\leq 5\text{mm}$, tolerance should be $\pm 0.3\text{mm}$; outline dimension $> 5\text{mm}$, tolerance should be $\pm 0.4\text{mm}$.
 2) The tolerance without indicating for PCB layout is always $\pm 0.1\text{mm}$.
 3) The width of the gridding is 2.54mm.

性能曲线图

MAXIMUM SWITCHING POWER

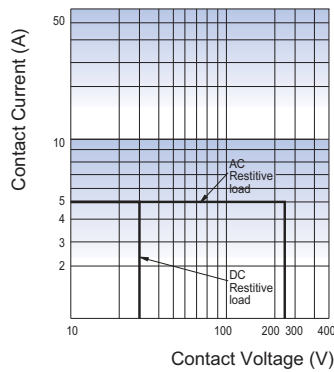

ENDURANCE CURVE

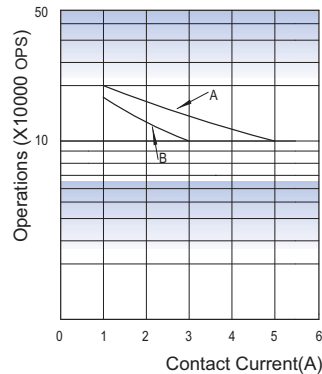

COIL TEMPERATURE RISE

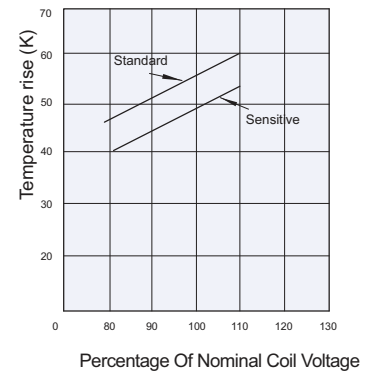

Remark:

- Curve A: standard
Curve B: sensitive
- Testing conditions:
Standard: flux proofed, resistive load, 5A 250VAC, at room temp. 1s on 9s off.
Sensitive: flux proofed, resistive load, 3A 250VAC, at room temp. 1s on 9s off.

Testing conditions:

- Standard: 5A at 85°C.
- Sensitive: 3A at 85°C
- Mounting distance: 5mm

Disclaimer

The specification is for reference only. See to "Terminology and Guidelines" for more information. Specifications subject to change without notice. We could not evaluate all the performance and all the parameters for every possible application. Thus the user should be in a right position to choose the suitable product for their own application. If there is any query, please contact Hongfa for the technical service. However, it is the user's responsibility to determine which product should be used only.

HF32FV-G

SUBMINIATURE INTERMEDIATE POWER RELAY



File No.:E134517



File No.:40012204



File No.:CQC14002120720



Features

- 10A switching capability
- Creepage distance: 6.5mm (between coil & contacts)
- Dielectric strength 4kV (between coil and contacts)
- 1 Form A configurations
- Standard PCB layout
- Plastic sealed and flux proofed types available
- Product in accordance to IEC60335-1 available
- UL insulation system: Class F
- Environmental friendly product (RoHS compliant)
- Outline Dimensions: (18.4 x 10.2 x 15.3) mm

CONTACT DATA

Contact arrangement	1A	
Contact resistance	100mΩ max.(at 1A 6VDC)	
Contact material	AgSnO ₂ , AgCdO	
Contact rating (Res. load)	Standard	Sensitive
	10A 250VAC 10A 30VDC	8A 250VAC 8A 30VDC
Max. switching voltager	277VAC / 30VDC	
Max. switching current	10A	8A
Max. switching power	2500VA/300W	2000VA/ 240W
Mechanical endurance	1 x 10 ⁷ OPS	
Electrical endurance	Standard	1 x 10 ⁵ OPS (10A 250VAC Resistive load, at room temp., 1s on 9s off) 5 x 10 ⁴ OPS (10A 250VAC Resistive load, at 85°C, 1s on 9s off)
	Sensitive	1 x 10 ⁵ OPS (8A 250VAC Resistive load, at room temp., 1s on 9s off) 5 x 10 ⁴ OPS (8A 250VAC Resistive load, at 85°C, 1s on 9s off)

CHARACTERISTICS

Insulation resistance	1000MΩ (at 500VDC)	
Dielectric strength	Between coil & contacts	4000VAC 1min
	Between open contacts	1000VAC 1min
Surge withstand voltage	6kV(1.2 / 50μs)	
Operate time (at nomi. volt.)	8ms max.	
Release time (at nomi. volt.)	5ms max.	
Coil temperature rise(at nomi. volt.)	70k max.	
Shock * resistance	Functional	98m/s ²
	Destructive	980m/s ²
Vibration resistance *	Functional	10Hz to 55Hz 1.5mm DA
Humidity	5% to 85% RH	
Ambient temperature	-40°C to 85°C	
Termination	PCB	
Unit weight	Approx. 6g	
Construction	Plastic sealed, Flux proofed	

Notes: 1) The data shown above are initial values.

2) *Index is not in relay length direction.

3) In order to obtain better electrical endurance, it's better not use this product in the high temperature environment.

COIL

Coil power	Standard: Approx. 450mW; Sensitive: Approx. 200mW
------------	--

COIL DATA

at 23°C

Standard Type

Nominal Voltage VDC	Pick-up Voltage VDC max.	Drop-out Voltage VDC min.	Max. Voltage VDC *	Coil Resistance Ω
3	2.25	0.15	3.9	20 x (1±10%)
5	3.75	0.25	6.5	55 x (1±10%)
6	4.50	0.30	7.8	80 x (1±10%)
9	6.75	0.45	11.7	180 x (1±10%)
12	9.00	0.60	15.6	320 x (1±10%)
18	13.5	0.90	23.4	720 x (1±10%)
24	18.0	1.20	31.2	1280 x (1±10%)
48	36.0	2.40	62.4	5120 x (1±10%)

Sensitive Type

Nominal Voltage VDC	Pick-up Voltage VDC max.	Drop-out Voltage VDC min.	Max. Voltage VDC *	Coil Resistance Ω
3	2.25	0.15	4.5	45 x (1±10%)
5	3.75	0.25	7.5	125 x (1±10%)
6	4.50	0.30	9.0	180 x (1±10%)
9	6.75	0.45	13.5	400 x (1±10%)
12	9.00	0.60	18.0	720 x (1±10%)
18	13.5	0.90	27.0	1600 x (1±10%)
24	18.0	1.20	36.0	2800 x (1±10%)
48	36.0	2.40	72.0	11520 x (1±10%)

Notes: * Maximum voltage refers to the maximum voltage which relay coil could endure in a short period of time.



HONGFA RELAY

ISO9001, ISO/TS16949, ISO14001, OHSAS18001, IECQ QC 080000 CERTIFIED

SAFETY APPROVAL RATINGS

UL/CUL	AgSnO ₂	10A 277VAC /250VAC Resistive at 40°C 10A 277VAC/250VAC Resistive at 85°C 8A 277VAC/250VAC General Use (Sensitive) at 85°C TV-5 120VAC 40°C TV-3 120VAC(Sensitive) at 40°C
	AgCdO	10A 277VAC/250VAC General Use at 85°C 10A 30VDC Resistive at 85°C 10A 277VAC /250VAC Resistive at 105°C 10A 277VAC/250VAC Resistive at 45°C 8A 277VAC/250VAC Resistive (Sensitive) at 85°C
VDE	AgSnO ₂	10A 277VAC/250VAC Resistive at 85°C 8A 277VAC/250VAC Resistive(Sensitive) at 85°C
	AgCdO	10A 277VAC/250VAC Resistive at 85°C
CQC	AgSnO ₂	10A 277VAC/250VAC Resistive at 85°C 8A 277VAC/250VAC Resistive (Sensitive) at 85°C
	AgCdO	10A 277VAC/250VAC Resistive at 85°C

- Notes:** 1) Opening the vent hole under contact material AgSnO₂ testing.
2) All values unspecified are at room temperature.
3) Only typical loads are listed above. Other load specifications can be available upon request.

ORDERING INFORMATION

Type	HF32FV-G / 12 -H S L T F G (XXX)
Coil voltage	3, 5, 6, 9, 12, 18, 24, 48VDC
Contact arrangement	H: 1 Form A
Construction ¹⁾²⁾	S: Plastic sealed Nil: Flux proofed
Coil power	L: Sensitive ³⁾ Nil: Standard
Contact material	T: AgSnO ₂ Nil: AgCdO
Insulation standard	F: Class F
Contact plating ⁴⁾	G: Gold plated Nil: No gold plated
Special code ⁵⁾	XXX: Customer special requirement Nil: Standard

- Notes:** 1) We recommend flux proofed types for a clean environment (free from contaminations like H₂S, SO₂, NO₂, dust, etc.).
2) Contact is recommended for suitable condition and specifications if water cleaning or surface process is involved in assembling relays on PCB.
3) Sensitive loading: 8A.
4) For gold plated type, the min. switching current and min. switching voltage is 10mA 5VDC.
5) The customer special requirement express as special code after evaluating by Hongfa. e.g. (335) stands for product in accordance to IEC 60335-1 (GWT); (590) stands for product in accordance to TV loading. For standard type is TV-5, for sensitive type is TV-3.

OUTLINE DIMENSIONS, WIRING DIAGRAM AND PC BOARD LAYOUT

Unit: mm

Outline Dimensions

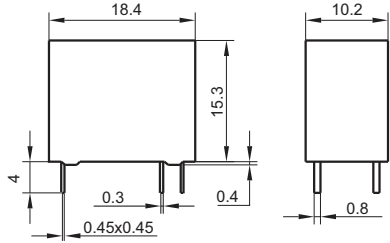

Wiring Diagram

(Bottom view)

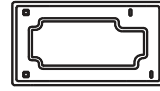

(Bottom view)

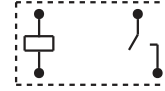

PCB Layout

(Bottom view)

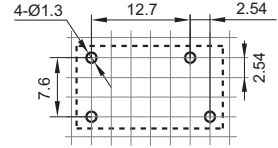

- Remark: 1) In case of no tolerance shown in outline dimension: outline dimension $\leq 1\text{mm}$, tolerance should be $\pm 0.2\text{mm}$; outline dimension $> 1\text{mm}$ and $\leq 5\text{mm}$, tolerance should be $\pm 0.3\text{mm}$; outline dimension $> 5\text{mm}$, tolerance should be $\pm 0.4\text{mm}$.
 2) The tolerance without indicating for PCB layout is always $\pm 0.1\text{mm}$.
 3) The width of the gridding is 2.54mm.

性能曲线图

MAXIMUM SWITCHING POWER

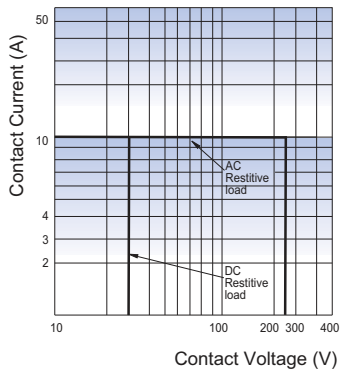

ENDURANCE CURVE

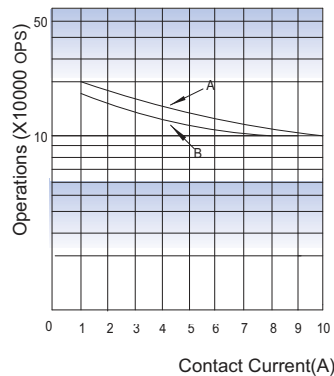

COIL TEMPERATURE RISE

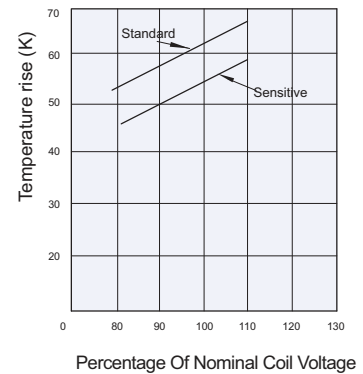

Remark:

- Curve A: standard
Curve B: sensitive
- Testing conditions:
Standard: flux proofed, resistive load, 10A/250VAC, at room temp. 1s on 9s off.
Sensitive: flux proofed, resistive load, 8A/250VAC, at room temp. 1s on 9s off.

Testing conditions:

- Standard: 10A at 85°C.
 Sensitive: 8A at 85°C
 Mounting distance: 10mm

Disclaimer

The specification is for reference only. See to "Terminology and Guidelines" for more information. Specifications subject to change without notice. We could not evaluate all the performance and all the parameters for every possible application. Thus the user should be in a right position to choose the suitable product for their own application. If there is any query, please contact Hongfa for the technical service. However, it is the user's responsibility to determine which product should be used only.

HF32F

SUBMINIATURE INTERMEDIATE POWER RELAY



File No.: E134517



File No.: 40012204



File No.: CQC12002076528



Features

- 10A switching capability
- 1 Form A and 1 Form C configurations
- Subminiature, standard PCB layout
- Plastic sealed and flux proofed types available
- UL insulation system: Class F
- Product in accordance to IEC 60335-1 available
- Environmental friendly product (RoHS compliant)
- Outline Dimensions: (18.4 x 10.2 x 15.3) mm

CONTACT DATA

Contact arrangement	1A, 1C			
Contact resistance	100mΩ max(at 1A 6VDC)			
Contact material	AgNi, AgCdO			
Contact rating (Res. load)	1A		1C	
	H type: 5A 250VAC 5A 30VDC 10A 125VAC	HL type: 3A 250VAC 3A 30VDC	NO 5A 250VAC 5A 30VDC 10A 125VAC	NC 3A 250VAC 3A 30VDC
Max. switching current	10A		3A	
Max. switching power	1250VA/150W		750VA/90W	
Max. switching voltage	250VAC/30VDC			
Mechanical endurance	5 x 10 ⁶ OPS			
Electrical endurance	H type: 1 x 10 ⁵ OPS (5A 250VAC, Resistive load, Room temp., 1s on 1s off)			
	HL type: 1x 10 ⁵ OPS (3A 250VAC, Resistive load, Room temp., 1s on 1s off)			
	Z type: 1x 10 ⁵ OPS (NO:3A/NC:3A, 250VAC, Resistive load, Room temp., 1.5s on 1.5s off)			

CHARACTERISTICS

Insulation resistance	1000MΩ (at 500VDC)	
Dielectric strength	Between coil & contacts	2500VAC 1min
	Between open contacts	1000VAC 1min
Operate time (at nomi. volt.)	8ms max.	
Release time (at nomi. volt.)	5ms max.	
Humidity	5% to 85% RH	
Ambient temperature	-40°C to 70°C	
Shock resistance	Functional	98m/s ²
	Destructive	980m/s ²
Vibration resistance	10Hz to 55Hz 1.5mm DA	
Termination	PCB	
Unit weight	Approx. 6g	
Construction	Plastic sealed, Flux proofed	

Notes: 1) The data shown above are initial values.

COIL

Coil power	Standard: Approx. 450mW; Sensitive: Approx.200mW
------------	---

COIL DATA

at 23°C

Standard type

Nominal Voltage VDC	Pick-up Voltage VDC max.	Drop-out Voltage VDC min.	Max. Voltage VDC *	Coil Resistance Ω
3	2.25	0.15	3.9	20 x (1±10%)
5	3.75	0.25	6.5	55 x (1±10%)
6	4.50	0.30	7.8	80 x (1±10%)
9	6.75	0.45	11.7	180 x (1±10%)
12	9.00	0.60	15.6	320 x (1±10%)
18	13.5	0.90	23.4	720 x (1±10%)
24	18.0	1.20	31.2	1280 x (1±10%)
48	36.0	2.40	62.4	5120 x (1±10%)

Sensitive type (Only for 1 Form A)

Nominal Voltage VDC	Pick-up Voltage VDC max.	Drop-out Voltage VDC min.	Max. Voltage VDC *	Coil Resistance Ω
3	2.25	0.15	4.5	45 x (1±10%)
5	3.75	0.25	7.5	125 x (1±10%)
6	4.50	0.30	9.0	180 x (1±10%)
9	6.75	0.45	13.5	400 x (1±10%)
12	9.00	0.60	18.0	720 x (1±10%)
18	13.5	0.90	27.0	1600 x (1±10%)
24	18.0	1.20	36.0	2800 x (1±10%)
48	36.0	2.40	72.0	11520 x (1±10%)

Notes: *Maximum voltage refers to the maximum voltage which relay coil could endure in a short period of time.



HONGFA RELAY

ISO9001, ISO/TS16949, ISO14001, OHSAS18001, IECQ QC 080000 CERTIFIED

SAFETY APPROVAL RATINGS

UL/CUL	1 Form A	AgCdO, AgNi	H type: 5A 250VAC /30VDC at 70°C 10A 125VAC at 70°C HL type: 3A 250VAC /30VDC at 70°C
		AgCdO	H type: 1/10HP 125VAC at 70°C 1/6HP 250VAC at 70°C 10LRA /1.5FLA 120VAC at 70°C HL type: 5A 125VAC at 70°C
	1 Form C	AgCdO, AgNi	3A 250VAC/30VDC at 70°C
VDE	1 Form A	AgCdO, AgNi	H type: 5A 250VAC /30VDC at 70°C HL type: 3A 250VAC /30VDC at 70°C
	1 Form C	AgCdO, AgNi	3A 250VAC/30VDC at 70°C

Notes: 1) All values unspecified are at room temperature.

2) Only typical loads are listed above. Other load specifications can be available upon request.

ORDERING INFORMATION

Type	HF32F / 012 -H S L Q 3 (XXX)
Coil voltage	3, 5, 6, 9, 12, 18, 24, 48VDC
Contact arrangement	H: 1 Form A Z: 1 Form C
Construction ¹⁾	S: Plastic sealed Nil: Flux proofed
Coil Power	L: Sensitive (Only for 1 Form A) Nil: Standard
Contact Capacity	Q: High Capacity (Only for Sensitive) Nil: Standard
Contact material	3: AgNi Nil: AgCdO
Special code ³⁾	XXX: Customer special requirement Nil: Standard

Notes: 1) Under the ambience with dangerous gas like H₂S, SO₂ or NO₂, plastic sealed type is recommended; Please test the relay in real applications. If the ambience allows, flux proofed type is preferentially recommended.

2) Contact is recommended for suitable condition and specifications if water cleaning or surface process is involved in assembling relays on PCB.

3) The customer special requirement express as special code after evaluating by Hongfa. e.g.(335) stands for product in accordance to IEC 60335-1 (GWT).

OUTLINE DIMENSIONS, WIRING DIAGRAM AND PC BOARD LAYOUT

Unit: mm

Outline Dimensions

Wiring Diagram (Bottom view)

PCB Layout (Bottom view)

1 Form A

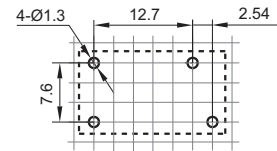
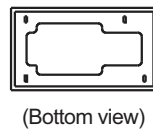
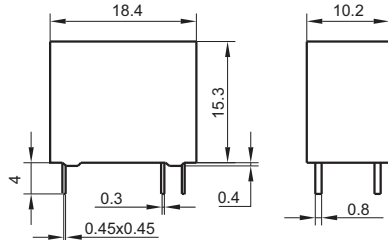

1 Form C

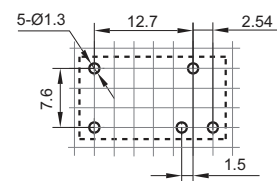
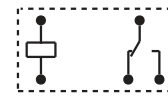
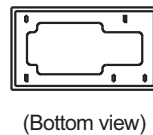
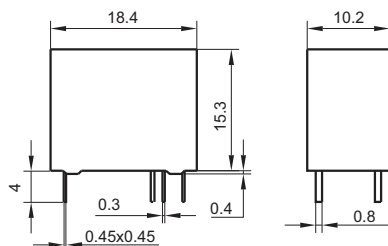

- Remark: 1) In case of no tolerance shown in outline dimension: outline dimension $\leq 1\text{mm}$, tolerance should be $\pm 0.2\text{mm}$; outline dimension $> 1\text{mm}$ and $\leq 5\text{mm}$, tolerance should be $\pm 0.3\text{mm}$; outline dimension $> 5\text{mm}$, tolerance should be $\pm 0.4\text{mm}$.
 2) The tolerance without indicating for PCB layout is always $\pm 0.1\text{mm}$.
 3) The width of the gridding is 2.54mm.

CHARACTERISTIC CURVES

MAXIMUM SWITCHING POWER

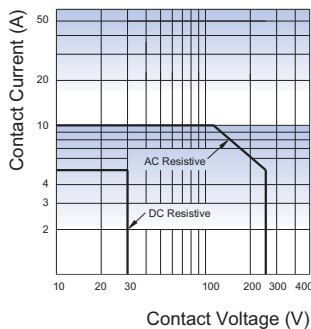

EDURANCE CURVE

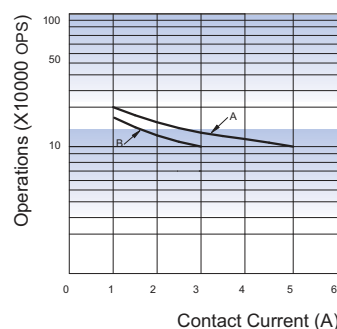

COIL TEMPERATURE RISE

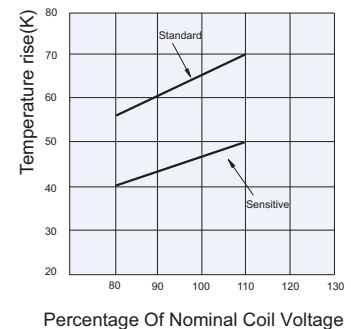

Notes:

- Curve A: H type
Curve B: HL type, Z type
- Test conditions:**
H type: Resistive load, 5A 250VAC, Room temp., 1s on 1s off
HL type: Resistive load, 5A 250VAC, Room temp., 1s on 1s off
Z type: NO/NC, Resistive load, 3A 250VAC, Room temp., 1.5s on 1.5s off

Test conditions:

- Standard: 5A at 70°C
Sensitive: 3A at 70°C
Mounting distance: 5mm

Disclaimer

The specification is for reference only. See to "Terminology and Guidelines" for more information. Specifications subject to change without notice. We could not evaluate all the performance and all the parameters for every possible application. Thus the user should be in a right position to choose the suitable product for their own application. If there is any query, please contact Hongfa for the technical service. However, it is the user's responsibility to determine which product should be used only.

HF32F-G

SUBMINIATURE INTERMEDIATE POWER RELAY



File No.: E134517



File No.: 40012204



File No.: CQC12002076528



Features

- 10A switching capability
- 1 Form A configuration
- Subminiature, standard PCB layout
- Plastic sealed and flux proofed types
- Product in accordance to IEC 60335-1 available
- UL insulation system: Class F
- Outline Dimensions: (18.4 x 10.2 x 15.3) mm

CONTACT DATA

Contact arrangement	1A
Contact resistance	100mΩ max.(at 1A 6VDC)
Contact material	AgSnO ₂ , AgNi, AgCdO
Contact rating (Res. load)	10A 250VAC 10A 30VDC
Max. switching voltage	250VAC / 30VDC
Max. switching current	10A
Max. switching power	2500VA / 300W
Mechanical endurance	1 x 10 ⁶ OPS
Electrical endurance	1 x 10 ⁵ OPS (10A 250VAC, Resistive load, Room temp., 1s on 9s off)

CHARACTERISTICS

Insulation resistance	1000MΩ (at 500VDC)	
Dielectric strength	Between coil & contacts	2500VAC 1min
	Between open contacts	1000VAC 1min
Operate time (at nomi. volt.)	8ms max.	
Release time (at nomi. volt.)	5ms max.	
Humidity	5% to 85% RH	
Ambient temperature	-40°C to 85°C	
Shock resistance	Functional	98m/s ²
	Destructive	980m/s ²
Vibration resistance	10Hz to 55Hz 1.5mm DA	
Termination	PCB	
Unit weight	Approx. 6g	
Construction	Plastic sealed, Flux proofed	

Notes: 1) The data shown above are initial values.

COIL

Coil power	Approx. 450mW
------------	---------------

COIL DATA

at 23°C

Nominal Voltage VDC	Pick-up Voltage VDC max.	Drop-out Voltage VDC min.	Max. Voltage VDC *	Coil Resistance Ω
3	2.25	0.15	3.9	20 x (1±10%)
5	3.75	0.25	6.5	55 x (1±10%)
6	4.50	0.30	7.8	80 x (1±10%)
9	6.75	0.45	11.7	180 x (1±10%)
12	9.00	0.60	15.6	320 x (1±10%)
18	13.5	0.90	23.4	720 x (1±10%)
24	18.0	1.20	31.2	1280 x (1±10%)
48	36.0	2.40	62.4	5120 x (1±10%)

Notes: *Maximum voltage refers to the maximum voltage which relay coil could endure in a short period of time.

SAFETY APPROVAL RATINGS

UL/CUL	10A 277VAC / 250VAC / 30VDC at 85°C
	12A 125VAC at 85°C
VDE	10A 250VAC at 85°C
	4A 400VAC at 85°C

Notes: 1) All values unspecified are at room temperature.

2) Only typical loads are listed above. Other load specifications can be available upon request.



HONGFA RELAY

ISO9001, ISO/TS16949, ISO14001, OHSAS18001, IECQ QC 080000 CERTIFIED

ORDERING INFORMATION

Type	HF32F-G /	012	-H	S	3	(XXX)
Coil voltage	3, 5, 6, 9, 12, 18, 24, 48VDC					
Contact arrangement	H: 1 Form A					
Construction ¹⁾	S: Plastic sealed		Nil: Flux proofed			
Contact material	T: AgSnO ₂		3: AgNi		Nil: AgCdO	
Special code ³⁾	XXX: Customer special requirement			Nil: Standard		

Notes: 1) Under the ambience with dangerous gas like H₂S, SO₂ or NO₂, plastic sealed type is recommended; please test the relay in real applications. If the ambience allows, flux proofed is preferentially recommended.

2) Contact is recommended for suitable condition and specifications if water cleaning or surface process is involved in assembling relays on PCB.

3) The customer special requirement express as special code after evaluating by Hongfa. e.g.(335) stands for product in accordance to IEC 60335-1 (GWT).

OUTLINE DIMENSIONS, WIRING DIAGRAM AND PC BOARD LAYOUT

Unit: mm

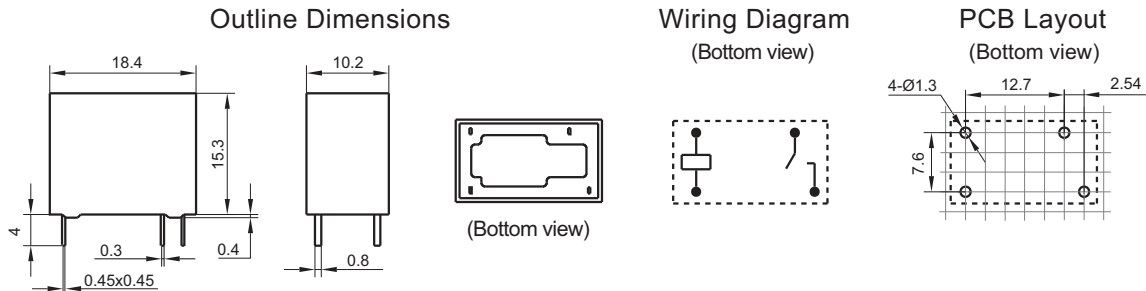

Remark: 1) In case of no tolerance shown in outline dimension: outline dimension ≤ 1 mm, tolerance should be ± 0.2 mm; outline dimension > 1 mm and ≤ 5 mm, tolerance should be ± 0.3 mm; outline dimension > 5 mm, tolerance should be ± 0.4 mm.

2) The tolerance without indicating for PCB layout is always ± 0.1 mm.

3) The width of the gridding is 2.54mm.

CHARACTERISTIC CURVES

MAXIMUM SWITCHING POWER

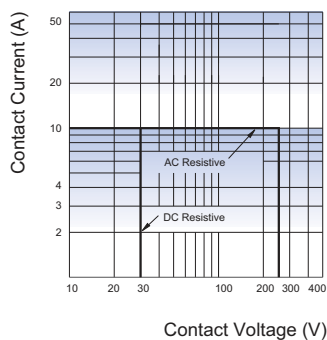

EDURANCE CURVE

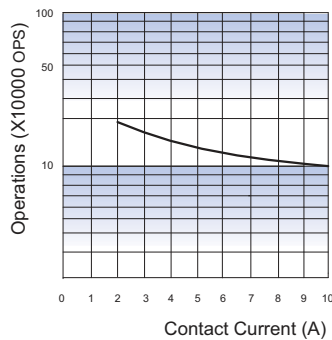

Test conditions:
Resistive load, 10A 250VAC,
Room temp., 1s on 9s off

COIL TEMPERATURE RISE

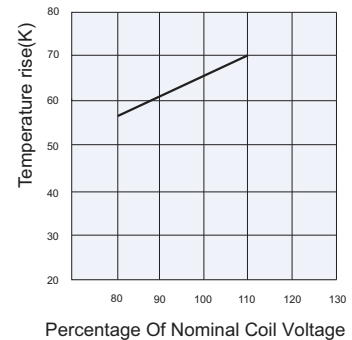

Test conditions: 10A 250VAC
Mounting distance: 10mm

Disclaimer

The specification is for reference only. See to "Terminology and Guidelines" for more information. Specifications subject to change without notice. We could not evaluate all the performance and all the parameters for every possible application. Thus the user should be in a right position to choose the suitable product for their own application. If there is any query, please contact Hongfa for the technical service. However, it is the user's responsibility to determine which product should be used only.

HF33F

SUBMINIATURE INTERMEDIATE POWER RELAY



File No.:E134517



File No.:125661



File No.:CQC12002076530



Features

- 10A switching capability
- Creepage distance: 8mm (coil & contacts)
- Clearance distance: NO type 4.5mm, NC type 4mm
- 1 Form A and 1 Form C configurations
- Subminiature, standard PCB layout
- Plastic sealed and flux proofed types available
- UL insulation system: Class F
- Product in accordance to IEC 60335-1 available
- Environmental friendly product (RoHS compliant)
- Outline Dimensions: (20.5 x 10.2 x 15.3) mm

CONTACT DATA

Contact arrangement	1A, 1C		
Contact resistance	100mΩ max.(at 1A 24VDC)		
Contact material	AgSnO ₂ , AgNi, AgCdO		
Contact rating (Res. load)	1A	1C	
	5A 250VAC 5A 30VDC 10A 125VAC	5A 250VAC 5A 30VDC 10A 125VAC	3A 250VAC 3A 30VDC
Max. switching current	10A	3A	
Max. switching power	1250VA / 150W	750VA / 90W	
Max. switching voltage	250VAC / 30VDC		
Mechanical endurance	5 x 10 ⁶ OPS		
Electrical endurance	H type:1 x 10 ⁵ OPS (5A 250VAC, Resistive load, Room temp., 1s on 9s off)		
	Z type:1 x 10 ⁵ OPS (NO:5A/NC:3A 250VAC,Resistive load, Room temp., 1.5s on 1.5s off)		

CHARACTERISTICS

Insulation resistance	1000MΩ (at 500VDC)	
Dielectric strength	Between coil & contacts	4000VAC 1min
	Between open contacts	1000VAC 1min
Operate time (at nomi. volt.)	8ms max.	
Release time (at nomi. volt.)	5ms max.	
Ambient temperature	-40°C to 70°C	
Humidity	5% to 85% RH	
Shock resistance	Functional	98m/s ²
	Destructive	980m/s ²
Vibration resistance	10Hz to 55Hz 1.6mm DA	
Termination	PCB	
Unit weight	Approx. 7g	
Construction	Plastic sealed, Flux proofed	

Notes: 1) The data shown above are initial values.

COIL

Coil power	Standard: Approx. 450mW; Sensitive: Approx. 200mW
------------	--

COIL DATA

at 23°C

Standard Type

Nominal Voltage VDC	Pick-up Voltage VDC max.	Drop-out Voltage VDC min.	Max. Voltage VDC *	Coil Resistance Ω
3	2.25	0.15	3.9	20 x (1±10%)
5	3.75	0.25	6.5	55 x (1±10%)
6	4.50	0.30	7.8	80 x (1±10%)
9	6.75	0.45	11.7	180 x (1±10%)
12	9.00	0.60	15.6	320 x (1±10%)
18	13.5	0.90	23.4	720 x (1±10%)
24	18.0	1.20	31.2	1280 x (1±10%)
48	36.0	2.40	62.4	5120 x (1±10%)

Sensitive type (Only for 1 Form A)

Nominal Voltage VDC	Pick-up Voltage VDC max.	Drop-out Voltage VDC min.	Max. Voltage VDC *	Coil Resistance Ω
3	2.25	0.15	4.5	45 x (1±10%)
5	3.75	0.25	7.5	125 x (1±10%)
6	4.50	0.30	9.0	180 x (1±10%)
9	6.75	0.45	13.5	400 x (1±10%)
12	9.00	0.60	18.0	720 x (1±10%)
18	13.5	0.90	27.0	1600 x (1±10%)
24	18.0	1.20	36.0	2800 x (1±10%)
48	36.0	2.40	72.0	11520 x (1±10%)

Notes: *Maximum voltage refers to the maximum voltage which relay coil could endure in a short period of time.



HONGFA RELAY

ISO9001, ISO/TS16949, ISO14001, OHSAS18001, IECQ QC 080000 CERTIFIED

SAFETY APPROVAL RATINGS

UL/CUL	1 Form A	AgCdO	5A 250VAC/30VDC at 40°C 8A 250VAC at 40°C 10A 125VAC at 40°C 10A 277VAC COSØ =0.4 at 40°C 1/10HP 125VAC, 1/6HP 250VAC at 40°C
		AgNi	5A 250VAC/30VDC at 70°C 8A 250VAC at 70°C 10A 125VAC at 70°C 10A 277VAC COSØ =0.4 at 70°C 1/10HP 125VAC, 1/6HP 250VAC at 70°C
		AgSnO ₂	5A 250VAC/30VDC at 70°C 10A 125VAC at 70°C
	1 Form C	AgCdO	3A 250VAC at 40°C 3A 30VDC at 40°C
		AgNi	3A 250VAC at 70°C
		AgSnO ₂	3A 30VDC at 70°C
VDE	1 Form A	AgNi	5A 250VAC at 85°C
		AgCdO	5A 250VAC at 70°C*
		AgSnO ₂	5A 250VAC at 70°C
	1 Form C	AgCdO	NC: 3A 250VAC at 70°C*
		AgNi	

- Notes: 1) *The vent hole is kept open during load approval:
 2) For AgSnO₂ Contact type, the vent-hole cover should be excised.
 3) All values unspecified are at room temperature.
 4) Only typical loads are listed above. Other load specifications can be available upon request.

ORDERING INFORMATION

Type	HF33F / 012 -H S L 3 G F (XXX)
Coil voltage	3, 5, 6, 9, 12, 18, 24, 48VDC
Contact arrangement	H: 1 Form A Z: 1 Form C
Construction ¹⁾	S: Plastic sealed Nil: Flux proofed
Coil power	L: Sensitive (Only for 1 Form A) Nil: Standard
Contact material	T: AgSnO ₂ 3: AgNi Nil: AgCdO
Contact plating	G: Gold plated Nil: No gold plated
Insulation standard	F: Class F
Special code ³⁾	XXX: Customer special requirement Nil: Standard

- Notes: 1) Under the ambience with dangerous gas like H₂S, SO₂ or NO₂, plastic sealed type is recommended; Please test the relay in real applications. If the ambience allows, flux proofed type is preferentially recommended.
 2) Contact is recommended for suitable condition and specifications if water cleaning or surface process is involved in assembling relays on PCB.
 3) The customer special requirement express as special code after evaluating by Hongfa.

OUTLINE DIMENSIONS, WIRING DIAGRAM AND PC BOARD LAYOUT

Unit: mm

Outline Dimensions

Wiring Diagram (Bottom view)

PCB Layout (Bottom view)

1 Form A

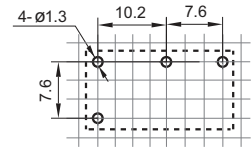
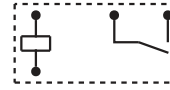
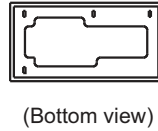
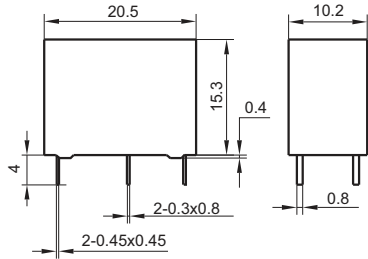

1 Form C

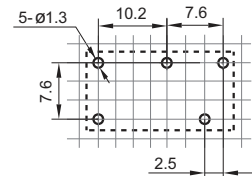
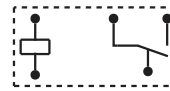
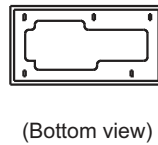
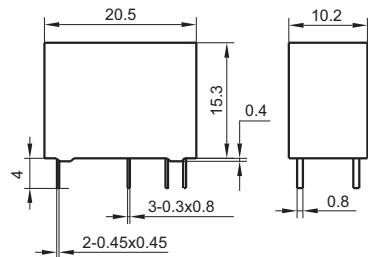

- Remark: 1) In case of no tolerance shown in outline dimension: outline dimension $\leq 1\text{mm}$, tolerance should be $\pm 0.2\text{mm}$; outline dimension $> 1\text{mm}$ and $\leq 5\text{mm}$, tolerance should be $\pm 0.3\text{mm}$; outline dimension $> 5\text{mm}$, tolerance should be $\pm 0.4\text{mm}$.
 2) The tolerance without indicating for PCB layout is always $\pm 0.1\text{mm}$.
 3) The width of the gridding is 2.54mm.

CHARACTERISTIC CURVES

MAXIMUM SWITCHING POWER

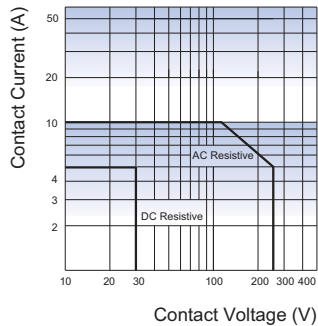

ENDURANCE CURVE

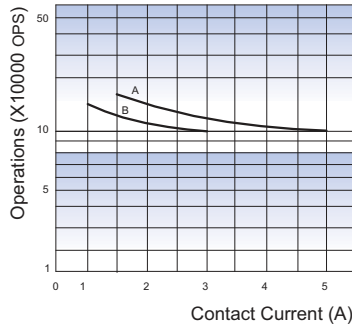

COIL TEMPERATURE RISE

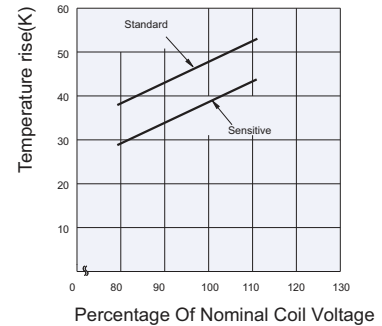

Notes:

- Curve A: NO contact
Curve B: NC contact
- Test conditions:
Curve A: NO, Resistive load, Room temp., flux proofed, 250VAC/30VDC, 1s on 9s off
Curve B: NC, Resistive load, Room temp., flux proofed, 250VAC/30VDC, 1s on 9s off

Notes:

- Standard: 5A at 70°C
 Sensitive: 5A at 70°C
 Mounting distance: 10mm

Disclaimer

The specification is for reference only. See to "Terminology and Guidelines" for more information. Specifications subject to change without notice. We could not evaluate all the performance and all the parameters for every possible application. Thus the user should be in a right position to choose the suitable product for their own application. If there is any query, please contact Hongfa for the technical service. However, it is the user's responsibility to determine which product should be used only.

HF36F

SUBMINIATURE INTERMEDIATE POWER RELAY



File No.:E134517



File No.:R50356442



File No.:CQC16002159838



Features

- 10A switching capability
- TV-5 125VAC approved by UL standard (only for 1 Form A)
- Plastic sealed and flux proofed types available
- 1 Form A and 1 Form C configurations
- Environmental friendly product (RoHS compliant)
- Outline Dimensions: (23.8 x 9.5 x 24.5) mm

CONTACT DATA

Contact arrangement	1A, 1C
Contact resistance	100mΩ max.(at 1A 6VDC)
Contact material	AgSnO ₂ , AgCdO
Contact rating	10A 250VAC 10A 30VDC TV-5 125VAC
Max. switching voltage	250VAC / 30VDC
Max. switching current	10A
Max. switching power	2500VA / 300W
Mechanical endurance	1 x 10 ⁷ OPS
Electrical endurance	5 x 10 ⁴ OPS (10A 250VAC, Resistive load, Room temp., 1s on 9s off)

CHARACTERISTICS

Insulation resistance	1000MΩ (at 500VDC)
Dielectric strength	Between coil & contacts NO: 4000VAC 1min NC: 3000VAC 1min
	Between open contacts 1000VAC 1min
Operate time (at nomi. volt.)	15ms max.
Release time (at nomi. volt.)	5ms max.
Humidity	5% to 85% RH
Ambient temperature	-40°C to 70°C
Shock resistance	Functional 196m/s ²
	Destructive 980m/s ²
Vibration resistance	10Hz to 55Hz 1.5mm DA
Termination	PCB
Unit weight	Approx. 12g
Construction	Plastic sealed, Flux proofed

- Notes:** 1) The data shown above are initial values.
2) Please find coil temperature curve in the characteristic curves below.
3) UL insulation system: Class A

COIL

Coil power	Standard: Approx. 530mW; Sensitive: Approx. 250mW
------------	--

COIL DATA

at 23°C

Standard type

Nominal Voltage VDC	Pick-up Voltage VDC max.	Drop-out Voltage VDC min.	Max. Voltage VDC *	Coil Resistance Ω
5	3.75	0.25	6.5	47 x (1±10%)
6	4.50	0.30	7.8	68 x (1±10%)
9	6.75	0.45	11.7	155 x (1±10%)
12	9.00	0.60	15.6	270 x (1±10%)
18	13.5	0.90	23.4	620 x (1±10%)
24	18.0	1.20	31.2	1080 x (1±10%)
48	36.0	2.40	62.4	4400 x (1±10%)

Sensitive type (Only for 1 Form A)

Nominal Voltage VDC	Pick-up Voltage VDC max.	Drop-out Voltage VDC min.	Max. Voltage VDC *	Coil Resistance Ω
5	3.75	0.25	6.5	100 x (1±10%)
6	4.50	0.30	7.8	145 x (1±10%)
9	6.75	0.45	11.7	325 x (1±10%)
12	9.00	0.60	15.6	575 x (1±10%)
18	13.5	0.90	23.4	1300 x (1±10%)
24	18.0	1.20	31.2	2310 x (1±10%)

Notes: *Maximum voltage refers to the maximum voltage which relay coil could endure in a short period of time.

SAFETY APPROVAL RATINGS

UL/CUL	1 Form C	10A 250VAC 10A 30VDC
	1 Form A	10A 250VAC 10A 30VDC TV-5 125VAC
TÜV		10A 250VAC COSØ =1 10A 30VDC L/R=0

- Notes:** 1) All values unspecified are at room temperature.
2) Only typical loads are listed above. Other load specifications can be available upon request.



HONGFA RELAY

ISO9001, ISO/TS16949, ISO14001, OHSAS18001, IECQ QC 080000 CERTIFIED

ORDERING INFORMATION

Type	HF36F / 012 -H S L T (XXX)					
Coil voltage	5, 6, 9, 12, 18, 24, 48VDC					
Contact arrangement	H: 1 Form A		Z: 1 Form C			
Construction ¹⁾	S: Plastic sealed		Nil: Flux proofed			
Coil power	L: Sensitive (Only for 1 Form A)		Nil: Standard			
Contact material	T: AgSnO ₂		Nil: AgCdO			
Special code ³⁾	XXX: Customer special requirement			Nil: Standard		

Notes: 1) Under the ambience with dangerous gas like H₂S, SO₂ or NO₂, plastic sealed type is recommended; Please test the relay in real applications. If the ambience allows, flux proofed type is preferentially recommended.

2) Contact is recommended for suitable condition and specifications if water cleaning or surface process is involved in assembling relays on PCB.

3) The customer special requirement express as special code after evaluating by Hongfa.

OUTLINE DIMENSIONS, WIRING DIAGRAM AND PC BOARD LAYOUT

Unit: mm

Outline Dimensions

1 Form A & Flux proofed

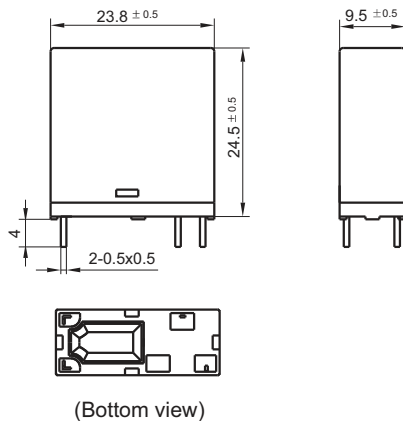

1 Form A & Plastic sealed

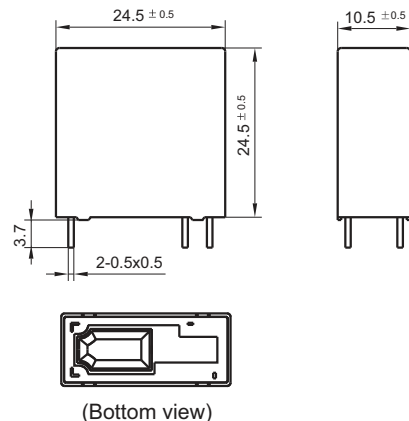

1 Form C & Flux proofed

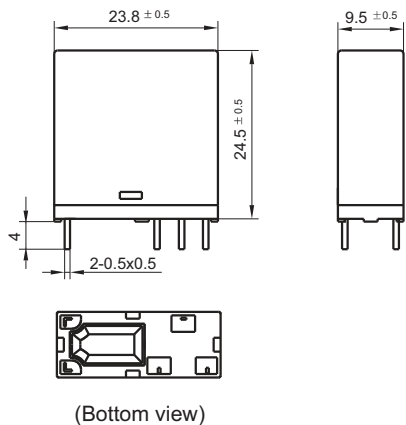

1 Form C & Plastic sealed

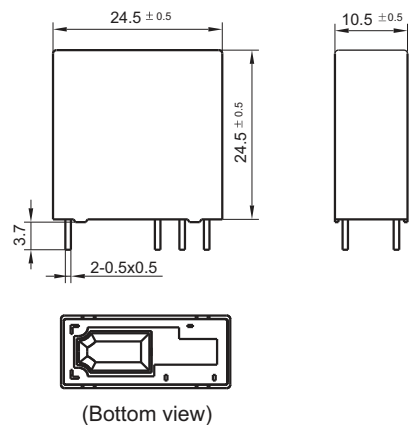

OUTLINE DIMENSIONS, WIRING DIAGRAM AND PC BOARD LAYOUT

Unit: mm

Wiring Diagram (Bottom view)

1 Form A

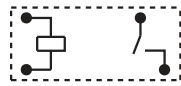

1 Form C

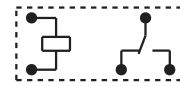

PCB Layout (Bottom view)

1 Form A

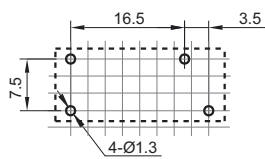

1 Form C

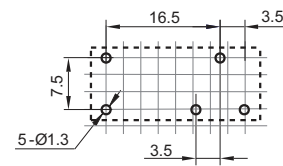

- Remark: 1) In case of no tolerance shown in outline dimension: outline dimension $\leq 1\text{mm}$, tolerance should be $\pm 0.2\text{mm}$; outline dimension $> 1\text{mm}$ and $\leq 5\text{mm}$, tolerance should be $\pm 0.3\text{mm}$; outline dimension $> 5\text{mm}$, tolerance should be $\pm 0.4\text{mm}$.
 2) The tolerance without indicating for PCB layout is always $\pm 0.1\text{mm}$.
 3) The width of the gridding is 2.5mm.

CHARACTERISTIC CURVES

ENDURANCE CURVE

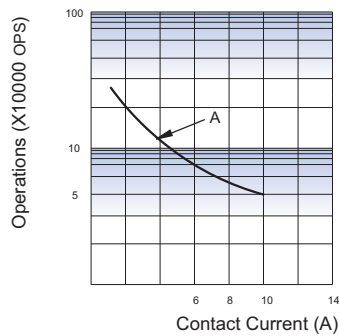

Notes:

- (1) Curve A: H type
- (2) Test conditions:
 10A 250VAC, Resistive load,
 Room temp., 1s on 9s off

COIL TEMPERATURE RISE

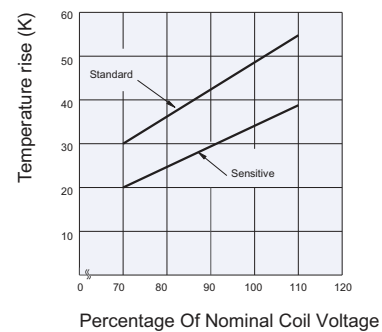

Disclaimer

The specification is for reference only. See to "Terminology and Guidelines" for more information. Specifications subject to change without notice. We could not evaluate all the performance and all the parameters for every possible application. Thus the user should be in a right position to choose the suitable product for their own application. If there is any query, please contact Hongfa for the technical service. However, it is the user's responsibility to determine which product should be used only.

HF36FD

SUBMINIATURE INTERMEDIATE POWER RELAY



File No.:E134517



File No.:R50356444



File No.:CQC16002159846



Features

- 10A switching capability
- TV-8 125VAC approved by UL standard (118A inrush current)
- Ideal for device power reduction
- Environmental friendly product (RoHS compliant)
- Outline Dimensions: (23.8 x 9.5 x 24.5) mm

CONTACT DATA

Contact arrangement	1A
Contact resistance	100mΩ max.(at 1A 6VDC)
Contact material	AgSnO ₂
Contact rating	10A 250VAC 5A 250VAC 5A 30VDC TV-8 125VAC
Max. switching voltage	250VAC / 30VDC
Max. switching current	10A
Max. switching power	2500VA / 150W
Mechanical endurance	1 x 10 ⁶ OPS 5 x 10 ⁴ OPS
Electrical endurance	(10A 250VAC, Resistive load, Room temp., 1s on 9s off)

CHARACTERISTICS

Insulation resistance	1000MΩ (at 500VDC)	
Dielectric strength	Between coil & contacts	4000VAC 1min
	Between open contacts	1000VAC 1min
Surge voltage	10kV (1.2 / 50μs)	
Operate time (at nomi. volt.)	15ms max.	
Release time (at nomi. volt.)	5ms max.	
Humidity	5% to 85% RH	
Ambient temperature	-40°C to 70°C	
Shock resistance	Functional	196m/s ²
	Destructive	980m/s ²
Vibration resistance	10Hz to 55Hz 1.5mm DA	
Termination	PCB	
Unit weight	Approx. 12g	
Construction	Flux proofed	

- Notes:** 1) The data shown above are initial values.
2) Please find coil temperature curve in the characteristic curves below.
3) UL insulation system: Class A

COIL

Coil power	Standard: Approx. 530mW; Sensitive: Approx. 250mW
------------	--

COIL DATA

at 23°C

Standard type

Nominal Voltage VDC	Pick-up Voltage VDC max.	Drop-out Voltage VDC min.	Max. Voltage VDC *	Coil Resistance Ω
5	3.75	0.25	6.5	47 x (1±10%)
6	4.50	0.30	7.8	68 x (1±10%)
9	6.75	0.45	11.7	155 x (1±10%)
12	9.00	0.60	15.6	270 x (1±10%)
18	13.5	0.90	23.4	620 x (1±10%)
24	18.0	1.20	31.2	1080 x (1±10%)
48	36.0	2.40	62.4	4400 x (1±10%)

Sensitive type

Nominal Voltage VDC	Pick-up Voltage VDC max.	Drop-out Voltage VDC min.	Max. Voltage VDC *	Coil Resistance Ω
5	4.00	0.25	6.5	100 x (1±10%)
6	4.80	0.30	7.8	145 x (1±10%)
9	7.20	0.45	11.7	325 x (1±10%)
12	9.60	0.60	15.6	575 x (1±10%)
18	14.4	0.90	23.4	1300 x (1±10%)
24	19.2	1.20	31.2	2310 x (1±10%)

Notes: *Maximum voltage refers to the maximum voltage which relay coil could endure in a short period of time.

SAFETY APPROVAL RATINGS

UL/CUL	10A 250VAC 5A 250VAC TV-8 125VAC
TÜV	10A 250VAC 5A 250VAC/30VDC

- Notes:** 1) All values unspecified are at room temperature.
2) Only typical loads are listed above. Other load specifications can be available upon request.

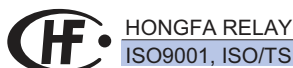

ISO9001, ISO/TS16949, ISO14001, OHSAS18001, IECQ QC 080000 CERTIFIED

ORDERING INFORMATION

Type	HF36FD / 012 -H L T (XXX)
Coil voltage	5, 6, 9, 12, 18, 24, 48VDC
Contact arrangement	H: 1 Form A
Coil power	L: Sensitive Nil: Standard
Contact material	T: AgSnO ₂
Special code ³⁾	XXX: Customer special requirement Nil: Standard

- Notes: 1) Water cleaning or surface process is not suggested after the flux-proofed relays are assembled on PCB.
 2) Flux-proofed relays can not be used in the environment with pollutants like H₂S, SO₂, NO₂, dust, etc.
 3) The customer special requirement express as special code after evaluating by Hongfa.

OUTLINE DIMENSIONS, WIRING DIAGRAM AND PC BOARD LAYOUT

Unit: mm

Outline Dimensions

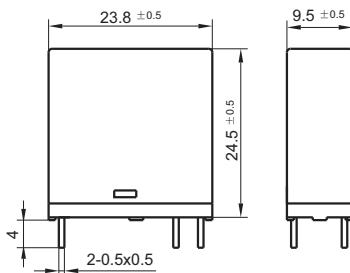

(Bottom view)

Wiring Diagram (Bottom view)

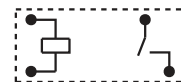

PCB Layout (Bottom view)

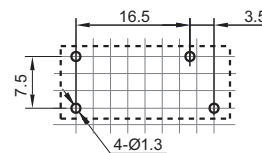

- Remark: 1) In case of no tolerance shown in outline dimension: outline dimension ≤ 1 mm, tolerance should be ± 0.2 mm; outline dimension > 1 mm and ≤ 5 mm, tolerance should be ± 0.3 mm; outline dimension > 5 mm, tolerance should be ± 0.4 mm.
 2) The tolerance without indicating for PCB layout is always ± 0.1 mm.
 3) The width of the gridding is 2.5mm.

CHARACTERISTIC CURVES

ENDURANCE CURVE

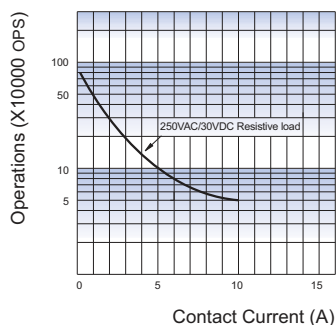

Test conditions:
 10A 250VAC, Resistive load,
 Room temp., 1s on 9s off.

COIL TEMPERATURE RISE

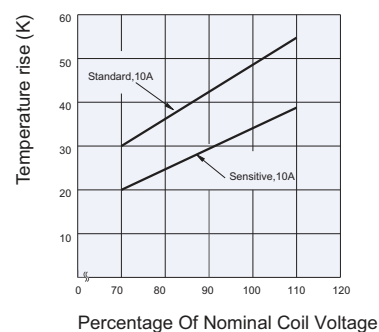

Disclaimer

The specification is for reference only. See to "Terminology and Guidelines" for more information. Specifications subject to change without notice. We could not evaluate all the performance and all the parameters for every possible application. Thus the user should be in a right position to choose the suitable product for their own application. If there is any query, please contact Hongfa for the technical service. However, it is the user's responsibility to determine which product should be used only.

© Xiamen Hongfa Electroacoustic Co., Ltd. All rights of Hongfa are reserved.

HF162F/HF162F-E

SUBMINIATURE INTERMEDIATE POWER RELAY



File No.:E133481



File No.:40032669



File No.:CQC10002050942



Features

- High inrush current: TV-8 125VAC (118A inrush current)
- 3A/100A 250VAC capacitive load
- Low height, only 9.3mm (excluding buttons)
- High sensitivity: 250mW,
Ideal for device power reduction
- Silent type available
- Typical applications: Flat-panel TVs, Audio visual equipment and other slim profile devices
- Environmental friendly product (RoHS compliant)
- Outline Dimensions: (26.3 x 26.1 x 10.0) mm

CONTACT DATA

Contact arrangement	1A
Contact resistance	100mΩ max.(at 1A 6VDC)
Contact material	Silver alloy
Contact rating	10A 125VAC 8A 277VAC 5A 277VAC TV-8 125VAC 3A/100A 250VAC (Capacitive) (Standard type)
Max. switching voltage	277VAC
Max. switching current	10A
Max. switching power	2216VA
Mechanical endurance	1 x 10 ⁶ OPS 5 x 10 ⁴ OPS
Electrical endurance	(10A 125VAC, Resistive load, Room temp., 1s on 9s off)

CHARACTERISTICS

Insulation resistance	1000MΩ (at 500VDC)	
Dielectric strength	Between coil & contacts	4000VAC 1min
	Between open contacts	1000VAC 1min
Surge voltage (between coil & contacts)	10kV (1.2 / 50μs)	
Operate time (at nomi. volt.)	15ms max.	
Release time (at nomi. volt.)	5ms max.	
Ambient temperature	-40°C to 70°C	
Humidity	5% to 85% RH	
Shock resistance	Functional	196m/s ²
	Destructive	980m/s ²
Vibration resistance	10Hz to 55Hz 1.5mm DA	
Termination	PCB	
Unit weight	Approx. 12g	
Construction	Flux proofed	

- Notes:** 1) The data shown above are initial values.
2) Please find coil temperature curve in the characteristic curves below.
3) UL insulation system: Class A

COIL

Coil power Approx. 250mW

COIL DATA

at 23°C

Standard type

Nominal Voltage VDC	Pick-up Voltage VDC max.	Drop-out Voltage VDC min.	Max. Voltage VDC*	Coil Resistance Ω
3	2.25	0.3	3.9	36 x (1±10%)
5	3.75	0.5	6.5	100 x (1±10%)
6	4.5	0.6	7.8	145 x (1±10%)
9	6.75	0.9	11.7	325 x (1±10%)
12	9.0	1.2	15.6	575 x (1±10%)
18	13.5	1.8	23.4	1300 x (1±10%)
24	18.0	2.4	31.2	2300 x (1±10%)

Silent type

Nominal Voltage VDC	Pick-up Voltage VDC max.	Drop-out Voltage VDC min.	Max. Voltage VDC*	Coil Resistance Ω
3	2.4	0.3	3.9	36 x (1±10%)
5	4.0	0.5	6.5	100 x (1±10%)
6	4.8	0.6	7.8	145 x (1±10%)
9	7.2	0.9	11.7	325 x (1±10%)
12	9.6	1.2	15.6	575 x (1±10%)
18	14.4	1.8	23.4	1300 x (1±10%)
24	19.2	2.4	31.2	2300 x (1±10%)

Notes: *Maximum voltage refers to the maximum voltage which relay coil could endure in a short period of time.

SAFETY APPROVAL RATINGS

UL/CUL	10A 125VAC
	8A 277VAC
	5A 277VAC
	TV-8 125VAC
VDE	8A 250VAC
	5A 250VAC
	3A/100A 250VAC(Standard type)

- Notes:** 1) All values unspecified are at room temperature.
2) Only typical loads are listed above. Other load specifications can be available upon request.



HONGFA RELAY

ISO9001, ISO/TS16949, ISO14001, OHSAS18001, IECQ QC 080000 CERTIFIED

ORDERING INFORMATION

	HF162F /	12	-H	(XXX)
Type	HF162F: Standard type HF162F-E: Silent type			
Coil voltage	3, 5, 6, 9, 12, 18, 24VDC			
Contact arrangement	H: 1 Form A			
Special code¹⁾	XXX: Customer special requirement	Nil: Standard		

Notes: 1) The customer special requirement express as special code after evaluating by Hongfa.

OUTLINE DIMENSIONS, WIRING DIAGRAM AND PC BOARD LAYOUT

Unit: mm

Outline Dimensions

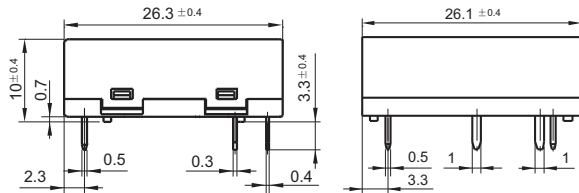

Wiring Diagram
(Bottom view)

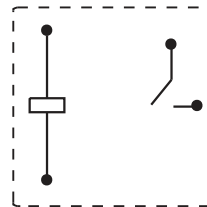

PCB Layout
(Bottom view)

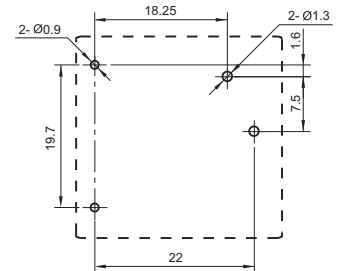

Remark: 1) In case of no tolerance shown in outline dimension: outline dimension $\leq 1\text{mm}$, tolerance should be $\pm 0.2\text{mm}$; outline dimension $> 1\text{mm}$ and $\leq 5\text{mm}$, tolerance should be $\pm 0.3\text{mm}$; outline dimension $> 5\text{mm}$, tolerance should be $\pm 0.4\text{mm}$.
2) The tolerance without indicating for PCB layout is always $\pm 0.1\text{mm}$.

CHARACTERISTIC CURVES

MAXIMUM SWITCHING POWER

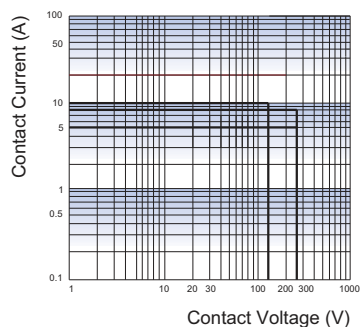

COIL TEMPERATURE RISE

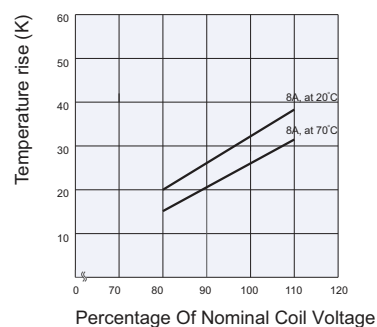

Disclaimer

The specification is for reference only. See to "Terminology and Guidelines" for more information. Specifications subject to change without notice. We could not evaluate all the performance and all the parameters for every possible application. Thus the user should be in a right position to choose the suitable product for their own application. If there is any query, please contact Hongfa for the technical service. However, it is the user's responsibility to determine which product should be used only.

© Xiamen Hongfa Electroacoustic Co., Ltd. All rights of Hongfa are reserved.

HF8

SUBMINIATURE INTERMEDIATE POWER RELAY



File No.:E134517



File No.:40025189



Features

- 4kV impulse withstand voltage (between coil and contacts)
- 1 Form A and 1 Form C configurations
- Subminiature, high sensitive, PCB layout
- Plastic sealed type for automatic wave soldering
- UL insulation system: Class F available
- Environmental friendly product (RoHS compliant)
- Outline Dimensions: (21.3 x 16.2 x 14.4) mm

CONTACT DATA

Contact arrangement	1A, 1C
Contact resistance	100mΩ max.(at 1A 24VDC)
Contact material	AgNi
Contact rating (Res. load)	HF8: 6A 300VAC/28VDC HF8A: 6A 277VAC/30VDC
Max. switching voltage	300VAC / 30VDC
Max. switching current	6A
Max. switching power	1800VA / 300W
Mechanical endurance	1 x 10 ⁷ OPS
Electrical endurance	Plastic sealed: 1 x 10 ⁴ OPS Flux proofed, Standard type: 1 x 10 ⁵ OPS Flux proofed, Sensitive type: 5 x 10 ⁴ OPS (NO, 6A 300VAC, Resistive load, Room temp., 1s on 9s off)

CHARACTERISTICS

Insulation resistance	100MΩ (at 500VDC)	
Dielectric strength	Between coil & contacts	2000VAC 1min
	Between open contacts	750VAC 1min
Operate time (at nomi. volt.)	6ms max.	
Release time (at nomi. volt.)	3ms max.	
Humidity	5% to 85% RH	
Ambient temperature	-55°C to 90°C	
Shock resistance	Functional	98m/s ²
	Destructive	980m/s ²
Vibration resistance	10Hz to 55Hz 1.5mm DA	
Termination	PCB	
Unit weight	Approx. 11g	
Construction	Plastic sealed, Flux proofed	

- Notes:** 1) The data shown above are initial values.
2) Please find coil temperature curve in the characteristic curves below.
3) UL insulation system: Class F, Class B, Class A.

COIL

Coil power	Standard: Approx. 450mW (48VDC: Approx. 600mW)
	Sensitive: Approx. 330mW

COIL DATA

at 23°C

Standard type

Nominal Voltage VDC	Pick-up Voltage VDC max.	Drop-out Voltage VDC min.	Max. Voltage VDC *	Coil Resistance Ω
3	2.25	0.15	3.90	20 x (1±10%)
5	3.75	0.25	6.50	56 x (1±10%)
6	4.50	0.30	7.80	80 x (1±10%)
9	6.75	0.45	11.7	180 x (1±10%)
12	9.00	0.60	15.6	320 x (1±10%)
18	13.5	0.90	23.4	720 x (1±10%)
24	18.0	1.20	31.2	1280 x (1±10%)
48	36.0	2.40	62.4	3800 x (1±10%)

Sensitive type

Nominal Voltage VDC	Pick-up Voltage VDC max.	Drop-out Voltage VDC min.	Max. Voltage VDC *	Coil Resistance Ω
3	2.25	0.15	3.90	28 x (1±10%)
5	3.75	0.25	6.50	80 x (1±10%)
6	4.50	0.30	7.80	110 x (1±10%)
9	6.75	0.45	11.7	250 x (1±10%)
12	9.00	0.60	15.6	440 x (1±10%)
18	13.5	0.90	23.4	1000 x (1±10%)
24	18.0	1.20	31.2	1780 x (1±10%)
48	36.0	2.40	62.4	7120 x (1±10%)

- Notes:** 1) When requiring pick-up voltage < 75% of nominal voltage, special order allowed.

- 2) *Maximum voltage refers to the maximum voltage which relay coil could endure in a short period of time.



HONGFA RELAY

ISO9001, ISO/TS16949, ISO14001, OHSAS18001, IECQ QC 080000 CERTIFIED

SAFETY APPROVAL RATINGS

UL/CUL	Medium Duty HF8-1CH/1AH	6A 28VDC 6A 300VAC
	General Duty HF8-1C/1A	2A 28VDC 2A 300VAC 3A 120VAC
	HF8A	6A 30VDC(NO/NC) 6A 277VAC(NO/NC)
VDE	HF8....A	2.5A 250VAC COS ϕ =0.4 2.5A 250VAC COS ϕ =0.5 5A 250VAC COS ϕ =1 6A 250VAC COS ϕ =1

Notes: 1) All values unspecified are at room temperature.

2) Only typical loads are listed above. Other load specifications can be available upon request.

ORDERING INFORMATION

	HF8 HF8A	-1C	H	-12	D	S	E	F	(XXX)
Type	HF8: Standard type HF8A: Low cost type								
Contact arrangement:	1A: 1 Form A 1C: 1 Form C								
Contact capacity	H: Medium Duty (6A) Nil: General Duty (3A/2A)								
Coil voltage	3, 5, 6, 9, 12, 18, 24, 48VDC								
Coil voltage form	D: DC								
Coil power	S: Sensitive Nil: Standard								
Construction ¹⁾	E: Plastic sealed Nil: Flux proofed								
Insulation standard	F: Class F A: Class A (VDE version, Only for HF8-1AH/1CH) Nil: Class B								
Special code ³⁾	XXX: Customer special requirement Nil: Standard								

Notes: 1) Under the ambience with dangerous gas like H₂S, SO₂ or NO₂, plastic sealed type is recommended; Please test the relay in real applications. If the ambience allows, flux proofed type is preferentially recommended.

2) Contact is recommended for suitable condition and specifications if water cleaning or surface process is involved in assembling relays on PCB.

3) The customer special requirement express as special code after evaluating by Hongfa.

OUTLINE DIMENSIONS, WIRING DIAGRAM AND PC BOARD LAYOUT

Unit: mm

Outline Dimensions

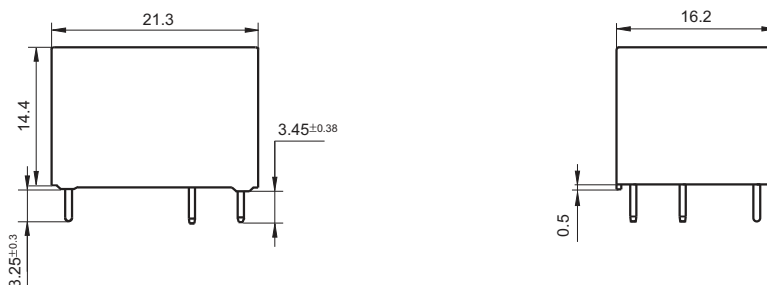

OUTLINE DIMENSIONS, WIRING DIAGRAM AND PC BOARD LAYOUT

Unit: mm

PCB Layout
(Bottom view)

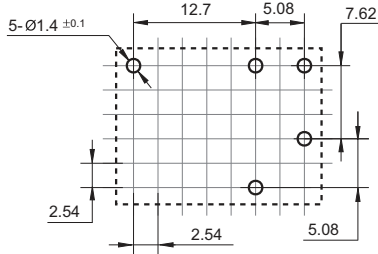

Wiring Diagram
(Bottom view)

1 Form A

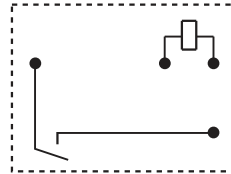

1 Form C

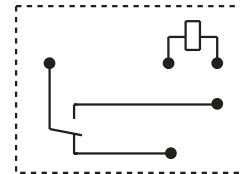

- Remark: 1) In case of no tolerance shown in outline dimension: outline dimension $\leq 1\text{mm}$, tolerance should be $\pm 0.2\text{mm}$; outline dimension $> 1\text{mm}$ and $\leq 5\text{mm}$, tolerance should be $\pm 0.3\text{mm}$; outline dimension $> 5\text{mm}$, tolerance should be $\pm 0.4\text{mm}$.
 2) The tolerance without indicating for PCB layout is always $\pm 0.1\text{mm}$.
 3) The width of the gridding is 2.54mm.
 4) Tin-dipped joint is tolerable after terminal tin-dipping as long as the terminal length including the joint is less than 4.0mm.

CHARACTERISTIC CURVES

MAXIMUM SWITCHING POWER

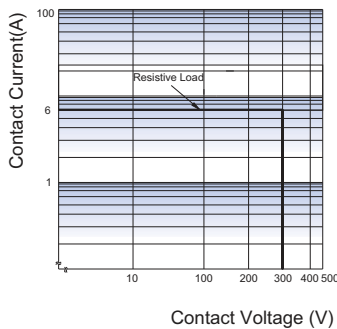

ENDURANCE CURVE

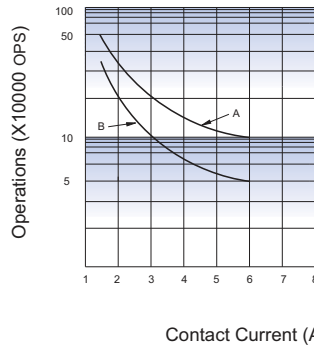

COIL TEMPERATURE RISE

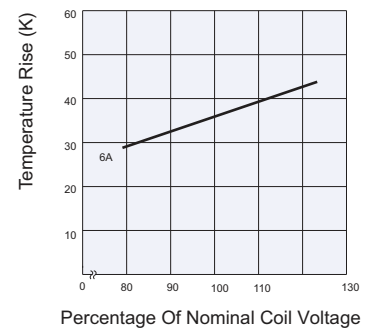

Notes:

- 1) Curve A: HF8-1CH Standard type
Curve B: HF8-1CH Sensitive type
- 2) Test conditions:
NO, 6A 300VAC, Resistive load,
Flux proofed, Room temp.
1s on 9s off

Disclaimer

The specification is for reference only. See to "Terminology and Guidelines" for more information. Specifications subject to change without notice. We could not evaluate all the performance and all the parameters for every possible application. Thus the user should be in a right position to choose the suitable product for their own application. If there is any query, please contact Hongfa for the technical service. However, it is the user's responsibility to determine which product should be used only.

© Xiamen Hongfa Electroacoustic Co., Ltd. All rights of Hongfa are reserved.

HF3FA

SUBMINIATURE HIGH POWER RELAY



File No.: E134517



File No.: 40023708



File No.: CQC12002076529



Features

- 15A switching capability
- Flammability class according to UL94, V-0
- CTI 250 available
- Product in accordance to IEC 60335-1 available
- 1 Form A and 1 Form C configurations
- Subminiature, standard PCB layout
- UL insulation system: Class F
- Environmental friendly product (RoHS compliant)
- Outline Dimensions: (19.0 x 15.5 x 15.5) mm

CONTACT DATA

Contact arrangement	1A	1C	
		NO	NC
Contact resistance	100mΩ max.(at 1A 6VDC)		
Contact material	AgSnO ₂		
Contact rating (Res. load)	10A 277VAC 10A 28VDC	10A 277VAC ¹⁾ 10A 28VDC ¹⁾	5A 250VAC
Max. switching voltage	277VAC/28VDC		250VAC
Max. switching current	15A	10A	5A
Max. switching power	2770VA /280W		
Mechanical endurance	1 x 10 ⁷ OPS		
Electrical endurance	H type:1 x 10 ⁵ OPS (10A 250VAC Resistive load, Room temp., 3s on 3s off)		
	Z type:5 x 10 ⁴ OPS (NO: 5A/NC: 5A 250VAC, Resistive load, Room temp., 5s on 5s off)		

Notes: 1) Applicable when NC is not energized with load.

CHARACTERISTICS

Insulation resistance	100MΩ (at 500VDC)	
Dielectric strength	Between coil & contacts	2500VAC 1min
	Between open contacts	750VAC 1min
Operate time (at nomi. volt.)	10ms max.	
Release time (at nomi. volt.)	5ms max.	
Shock resistance	Functional	98m/s ²
	Destructive	980m/s ²
Vibration resistance	10Hz to 55Hz 1.5mm DA	
Humidity	5% to 85% RH	
Ambient temperature	-40°C to 85°C	
Termination	PCB	
Unit weight	Approx. 7.0g	
Construction	Plastic sealed, Flux proofed	

Notes: 1) The data shown above are initial values.

COIL

Coil power Approx. 360mW

COIL DATA

at 23°C

Nominal Voltage VDC	Pick-up Voltage VDC max.	Drop-out Voltage VDC min.	Max. Voltage VDC *	Coil Resistance Ω
3	2.25	0.3	3.9	25 x (1±10%)
5	3.75	0.5	6.5	70 x (1±10%)
6	4.50	0.6	7.8	100 x (1±10%)
9	6.75	0.9	11.7	225 x (1±10%)
12	9.00	1.2	15.6	400 x (1±10%)
15	11.25	1.5	19.5	625 x (1±10%)
18	13.5	1.8	23.4	900 x (1±10%)
24	18.0	2.4	31.2	1600 x (1±10%)
48	36.0	4.8	54.4	6400 x (1±10%)

Notes: *Maximum voltage refers to the maximum voltage which relay coil could endure in a short period of time.

SAFETY APPROVAL RATINGS

UL/CUL	1 Form A	10A 250VAC at 85°C 8A 277VAC at 85°C 6A 250VAC at 105°C 15A 125VAC TV-5 120VAC
	1 Form C	NO/NC: 5A/5A 277VAC at 85°C
VDE	1 Form A	6A 250VAC at 105°C 10A 250VAC at 85°C
	1 Form C	NO: 10A 250VAC at 85°C NO: 6A 250VAC at 105°C NO/NC: 5A/5A 250VAC at 85°C

- Notes: 1) All values unspecified are at room temperature.
2) Only typical loads are listed above. Other load specifications can be available upon request.
3) For sealed type, the vent-hole cover should be excised.



HONGFA RELAY

ISO9001, ISO/TS16949, ISO14001, OHSAS18001, IECQ QC 080000 CERTIFIED

ORDERING INFORMATION

Type	HF3FA / 012 -H S T F (XXX)		
Coil voltage	3, 5, 6, 9, 12, 18, 24, 48VDC		
Contact arrangement	H: 1 Form A	Z: 1 Form C	
Construction ¹⁾	S: Plastic sealed	Nil: Flux proofed	
Contact material	T: AgSnO ₂	Nil: AgCdO	
Insulation system	F: Class F		
Special code ³⁾	XXX: Customer special requirement	Nil: Standard	

- Notes:** 1) We recommend flux proofed types for a clean environment (free from contaminations like H₂S, SO₂, NO₂, dust, etc.). We suggest to choose plastic sealed types and validate it in real application for an unclean environment (with contaminations like H₂S, SO₂, NO₂, dust, etc).
- 2) Contact is recommended for suitable condition and specifications if water cleaning or surface process is involved in assembling relays on PCB.
- 3) The customer special requirement express as special code after evaluating by Hongfa. e.g.(335) stands for product in accordance to IEC 60335-1 (GWT).

OUTLINE DIMENSIONS, WIRING DIAGRAM AND PC BOARD LAYOUT

Unit: mm

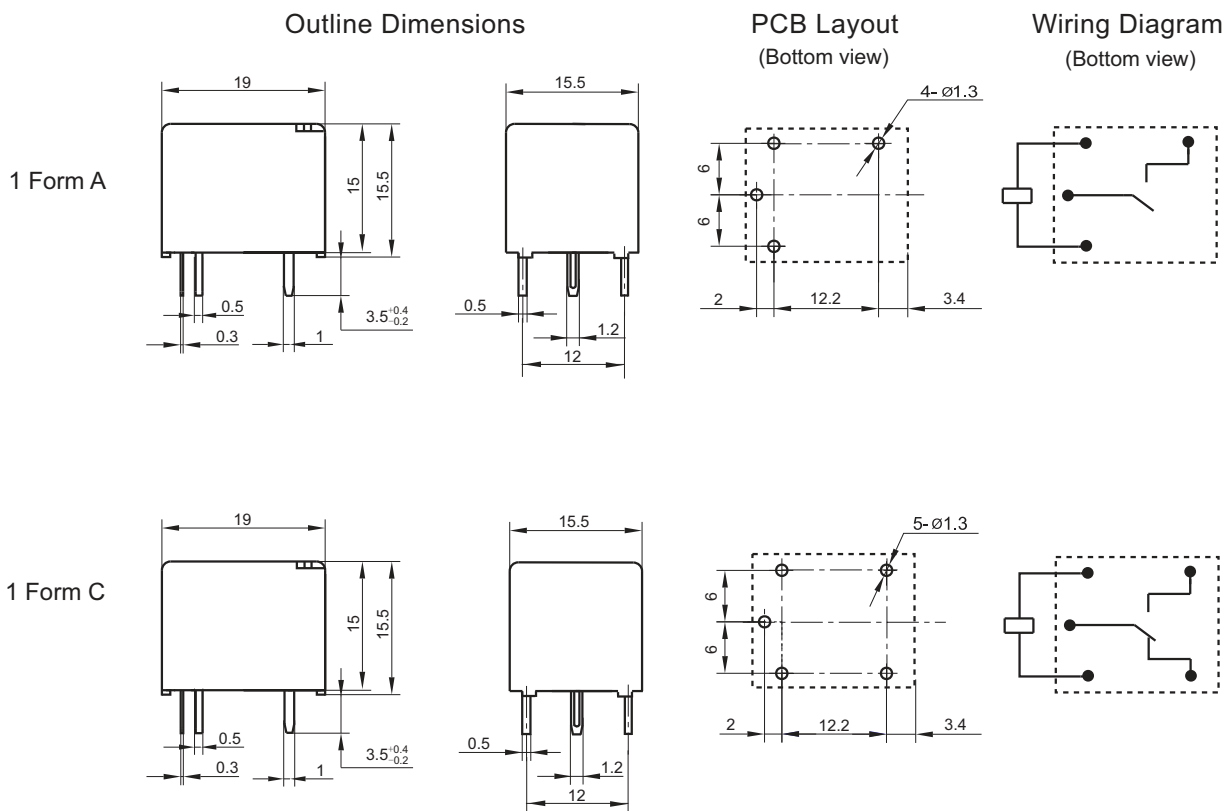

- Remark: 1) In case of no tolerance shown in outline dimension: outline dimension $\leq 1\text{mm}$, tolerance should be $\pm 0.2\text{mm}$; outline dimension $> 1\text{mm}$ and $\leq 5\text{mm}$, tolerance should be $\pm 0.3\text{mm}$; outline dimension $> 5\text{mm}$, tolerance should be $\pm 0.4\text{mm}$.
- 2) The tolerance without indicating for PCB layout is always $\pm 0.1\text{mm}$.

CHARACTERISTIC CURVES

MAXIMUM SWITCHING POWER

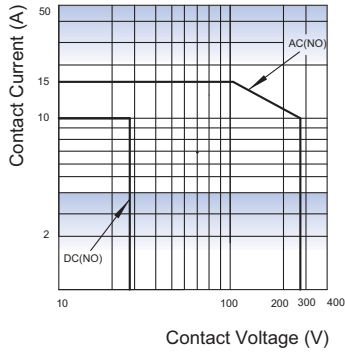

ENDURANCE CURVE

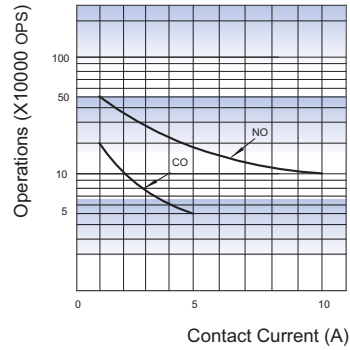

Test conditions:

NO: Resistive load, Flux proofed,
Room temp., 1s on 9s off

CO: Resistive load, Flux proofed,
Room temp., 3s on 3s off

COIL TEMPERATURE RISE

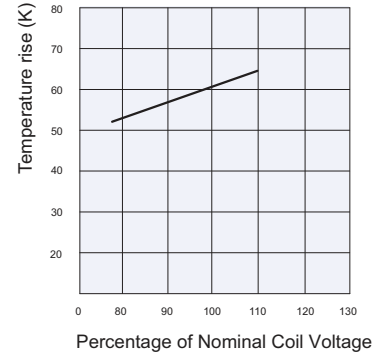

Test conditions: at 85°C, 6A
Mounting distance: 10mm

Disclaimer

The specification is for reference only. See to "Terminology and Guidelines" for more information. Specifications subject to change without notice. We could not evaluate all the performance and all the parameters for every possible application. Thus the user should be in a right position to choose the suitable product for their own application. If there is any query, please contact Hongfa for the technical service. However, it is the user's responsibility to determine which product should be used only.

HF3FD

SUBMINIATURE HIGH POWER RELAY



File No.: E134517



File No.: 40014057



File No.: CQC14002114760



Features

- 15A switching capability
- Flammability class according to UL94, V-0
- Product in accordance to IEC 60335-1 available
- 1 Form A and 1 Form C configurations
- Subminiature, standard PCB layout
- Plastic sealed and flux proofed types available
- UL insulation system: Class F available
- Environmental friendly product (RoHS compliant)
- Outline Dimensions: (19.0 x 15.2 x 15.5) mm

CONTACT DATA

Contact arrangement	1A	1C
Contact resistance	100mΩ max.(at 1A 6VDC)	
Contact material	AgSnO ₂	
Contact rating (Res. load)	10A 250VAC	NO: 10A 250VAC/28VDC NO/NC: 5A/5A 250VAC
Max. switching voltage	277VAC/30VDC	
Max. switching current	15A	10A
Max. switching power	2770VA / 300W	
Mechanical endurance	1 x 10 ⁷ OPS	
Electrical endurance ¹⁾	HT type: 5 x 10 ⁴ OPS (10A 250VAC, Resistive load, at 85°C, 5s on 5s off)	

CHARACTERISTICS

Insulation resistance	100MΩ (at 500VDC)	
Dielectric strength	Between coil & contacts	2000VAC 1min
	Between open contacts	750VAC 1min
Operate time (at nomi. volt.)	10ms max.	
Release time (at nomi. volt.)	5ms max.	
Shock resistance	Functional	98m/s ²
	Destructive	980m/s ²
Vibration resistance	10Hz to 55Hz 1.5mm DA	
Humidity	5% to 85% RH	
Ambient temperature	-40°C to 105°C	
Termination	PCB	
Unit weight	Approx. 10g	
Construction	Plastic sealed, Flux proofed	

- Notes:** 1) For sealed type, the vent-hole cover should be excised.
 2) The data shown above are initial values.
 3) Please find coil temperature curve in the characteristic curves below.
 4) UL insulation system: Class F, Class B.

COIL

Coil power	Approx. 360mW
------------	---------------

COIL DATA

at 23°C

Nominal Voltage VDC	Pick-up Voltage VDC max.	Drop-out Voltage VDC min.	Max. Voltage VDC *	Coil Resistance Ω
3	2.25	0.3	3.9	25 x (1±10%)
5	3.75	0.5	6.5	70 x (1±10%)
6	4.50	0.6	7.8	100 x (1±10%)
9	6.75	0.9	11.7	225 x (1±10%)
12	9.00	1.2	15.6	400 x (1±10%)
18	13.5	1.8	23.4	900 x (1±10%)
24	18.0	2.4	31.2	1600 x (1±10%)
48	36.0	4.8	62.4	6400 x (1±10%)

Notes: * Maximum voltage refers to the maximum voltage which relay coil could endure in a short period of time.

SAFETY APPROVAL RATINGS

UL/ CUL	AgSnO ₂	1 Form A	10A 250VAC at 85°C
		1 Form C	NO/NC: 5A/5A 250VAC at 85°C NO: 1/2HP 125VAC NO: TV-5 120VAC
VDE	AgSnO ₂	1 Form A	10A 250VAC at 85°C
		1 Form C	NO/NC: 5A/5A 250VAC at 85°C NO: 10A 250VAC at 85°C

- Notes:** 1) All values unspecified are at room temperature.
 2) Only typical loads are listed above. Other load specifications can be available upon request.



HONGFA RELAY

ISO9001, ISO/TS16949, ISO14001, OHSAS18001, IECQ QC 080000 CERTIFIED

ORDERING INFORMATION

HF3FD / 012 -H S T F (XXX)	
Type	
Coil voltage	3, 5, 6, 9, 12, 18, 24, 48VDC
Contact arrangement	H: 1 Form A Z: 1 Form C
Construction^{1) 2)}	S: Plastic sealed Nil: Flux proofed
Contact material	T: AgSnO ₂
Insulation standard	F: Class F Nil: Class B
Special code³⁾	XXX: Customer special requirement Nil: Standard

- Notes:** 1) We recommend flux proofed types for a clean environment (free from contaminations like H₂S, SO₂, NO₂, dust, etc.). We suggest to choose plastic sealed types and validate it in real application for an unclean environment (with contaminations like H₂S, SO₂, NO₂, dust, etc).
- 2) Contact is recommended for suitable condition and specifications if water cleaning or surface process is involved in assembling relays on PCB.
- 3) The customer special requirement express as special code after evaluating by Hongfa. e.g.(335) stands for product in accordance to IEC 60335-1 (GWT).

OUTLINE DIMENSIONS, WIRING DIAGRAM AND PC BOARD LAYOUT

Unit: mm

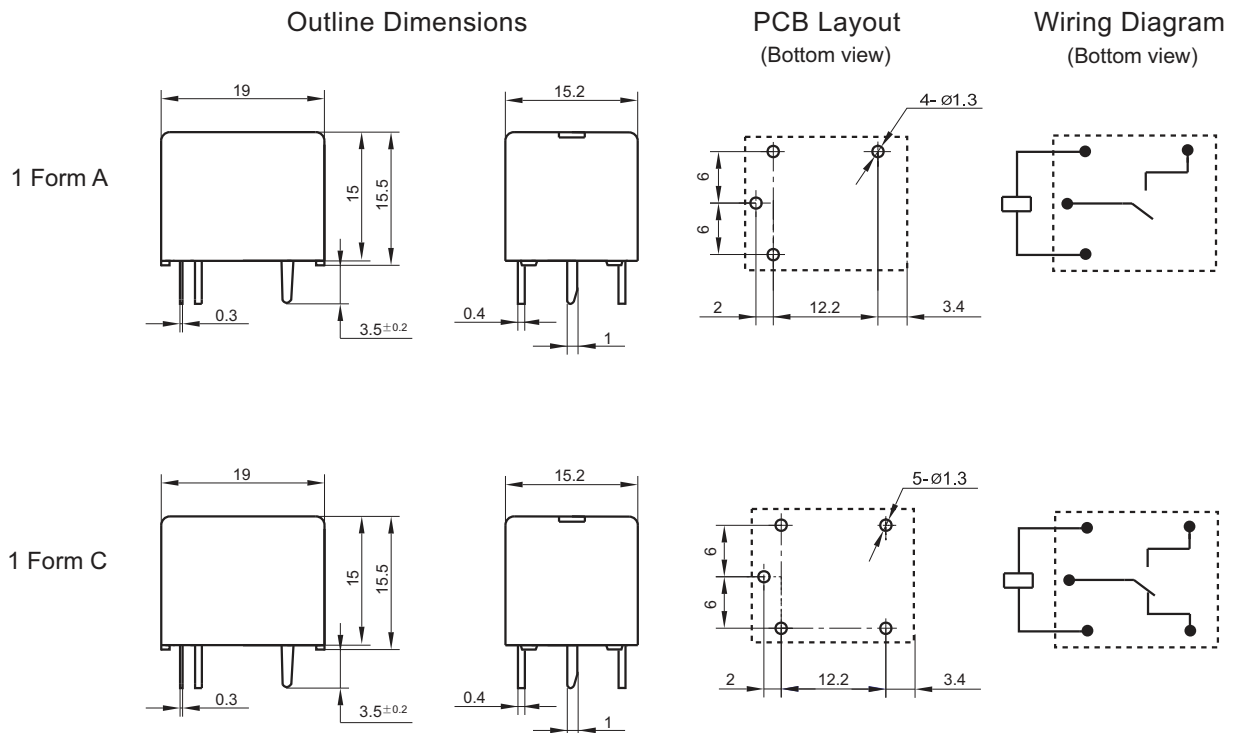

- Remark: 1) In case of no tolerance shown in outline dimension: outline dimension ≤ 1 mm, tolerance should be ± 0.2 mm; outline dimension > 1 mm and ≤ 5 mm, tolerance should be ± 0.3 mm; outline dimension > 5 mm, tolerance should be ± 0.4 mm.
- 2) The tolerance without indicating for PCB layout is always ± 0.1 mm.

CHARACTERISTIC CURVES

MAXIMUM SWITCHING POWER

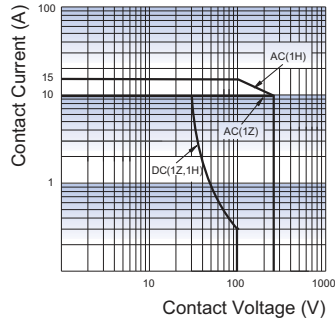

ENDURANCE CURVE

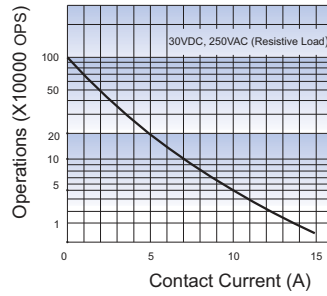

Test conditions:
NO, Flux proofed type,
Room temp., 1s on 9s off.

COIL TEMPERATURE RISE

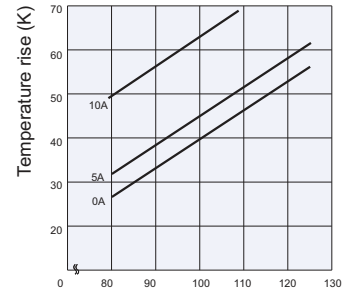

Percentage of Nominal Coil Voltage
(Relay mounting distance should be less than 10mm.)

Disclaimer

The specification is for reference only. See to "Terminology and Guidelines" for more information. Specifications subject to change without notice. We could not evaluate all the performance and all the parameters for every possible application. Thus the user should be in a right position to choose the suitable product for their own application. If there is any query, please contact Hongfa for the technical service. However, it is the user's responsibility to determine which product should be used only.

© Xiamen Hongfa Electroacoustic Co., Ltd. All rights of Hongfa are reserved.

HF3FF

SUBMINIATURE HIGH POWER RELAY



File No.:E134517



File No.:40025218



File No.:R50148356



File No.:CQC13002098175



Features

- 15A switching capability
- 1 Form A and 1 Form C configurations
- Subminiature, standard PCB layout
- Plastic sealed and flux proofed types available
- UL insulation system: Class F
- Environmental friendly product (RoHS compliant)
- Outline Dimensions: (19.0 x 15.2 x 15.5) mm

CONTACT DATA

Contact arrangement	1A	1C	
		NO	NC
Contact resistance	100mΩ max.(at 1A 6VDC)		
Contact material	AgSnO ₂ , AgCdO		
Contact rating (Res. load)	10A 277VAC 10A 28VDC	10A 277VAC ¹⁾ 10A 28VDC ¹⁾	5A 250VAC
Max. switching voltage	277VAC / 28VDC		250VAC
Max. switching current	15A	10A	5A
Max. switching power	2770VA / 280W		1250VA
Mechanical endurance	1 x 10 ⁷ OPS		
Electrical endurance	1H type: 1x 10 ⁵ OPS (10A 250VAC, Resistive load, Room temp., 1s on 9s off) 1Z type: 5 x 10 ⁴ OPS (NO: 5A/NC: 5A 250VAC, Resistive load, Room temp., 5s on 5s off)		

Notes: 1) Applicable when NC is not energized with load.

CHARACTERISTICS

Insulation resistance	100MΩ (at 500VDC)	
Dielectric strength	Between coil & contacts	1500VAC 1min
	Between open contacts	750VAC 1min
Operate time (at nomi. volt.)	10ms max.	
Release time (at nomi. volt.)	5ms max.	
Shock resistance	Functional	98m/s ²
	Destructive	980m/s ²
Vibration resistance	10Hz to 55Hz 1.5mm DA	
Humidity	5% to 85% RH	
Ambient temperature	-40°C to 70°C	
Termination	PCB	
Unit weight	Approx. 10g	
Construction	Plastic sealed, Flux proofed	

Notes: 1) The data shown above are initial values.

COIL

Coil power	5VDC to 24VDC: Approx. 360mW; 48VDC: Approx. 510mW
------------	---

COIL DATA

at 23°C

Nominal Voltage VDC	Pick-up Voltage VDC max.	Drop-out Voltage VDC min.	Max. Voltage VDC *	Coil Resistance Ω
5	3.80	0.5	6.5	70 x (1±10%)
6	4.50	0.6	7.8	100 x (1±10%)
9	6.80	0.9	11.7	225 x (1±10%)
12	9.00	1.2	15.6	400 x (1±10%)
18	13.5	1.8	23.4	900 x (1±10%)
24	18.0	2.4	31.2	1600 x (1±10%)
48	36.0	4.8	62.4	4500 x (1±10%)
48 ¹⁾	36.0	4.8	62.4	6400 x (1±10%)

Notes: 1) There are 2 types for 48V--510mW and 360mW. The coil resistance for 510mW type is 4500ohm while for that for 360mW type is 6400ohm. If 360mW type is required, please add a special suffix (068) in the ordering information.

2) *Maximum voltage refers to the maximum voltage which relay coil could endure in a short period of time.

SAFETY APPROVAL RATINGS

UL/CUL	1 Form A	10A 277VAC 10A 28VDC 15A 125VAC at 70°C 1/2HP 125VAC (AgSnO ₂)
	1 Form C	NO:10A 277VAC NO:10A 28VDC NO:10A 120VAC at 70°C NC:10A 120VAC at 70°C
VDE (only AgSnO ₂)	1 Form A	10A 250VAC at 70°C 12A 125VAC
	1 Form C	NO/NC:5A/5A 250VAC at 70°C NO:10A 250VAC at 70°C NO:12A 125VAC

Notes: 1) All values unspecified are at room temperature.

2) Only typical loads are listed above. Other load specifications can be available upon request.

3) For sealed type, the vent-hole cover should be excised.



HONGFA RELAY

ISO9001, ISO/TS16949, ISO14001, OHSAS18001, IECQ QC 080000 CERTIFIED

ORDERING INFORMATION

HF3FF / 012 -1H S T (XXX)	
Type	
Coil voltage	5, 6, 9, 12, 18, 24, 48VDC
Contact arrangement	1H:1 Form A 1Z:1 Form C
Construction ^{1) 2)}	S: Plastic sealed Nil: Flux proofed
Contact material	T: AgSnO ₂ Nil: AgCdO
Special code ³⁾	XXX: Customer special requirement Nil: Standard

- Notes:** 1) We recommend flux proofed types for a clean environment (free from contaminations like H₂S, SO₂, NO₂, dust, etc.).
 We suggest to choose plastic sealed types and validate it in real application for an unclean environment (with contaminations like H₂S, SO₂, NO₂, dust, etc).
 2) Contact is recommended for suitable condition and specifications if water cleaning or surface process is involved in assembling relays on PCB.
 3) The customer special requirement express as special code after evaluating by Hongfa.

OUTLINE DIMENSIONS, WIRING DIAGRAM AND PC BOARD LAYOUT

Unit: mm

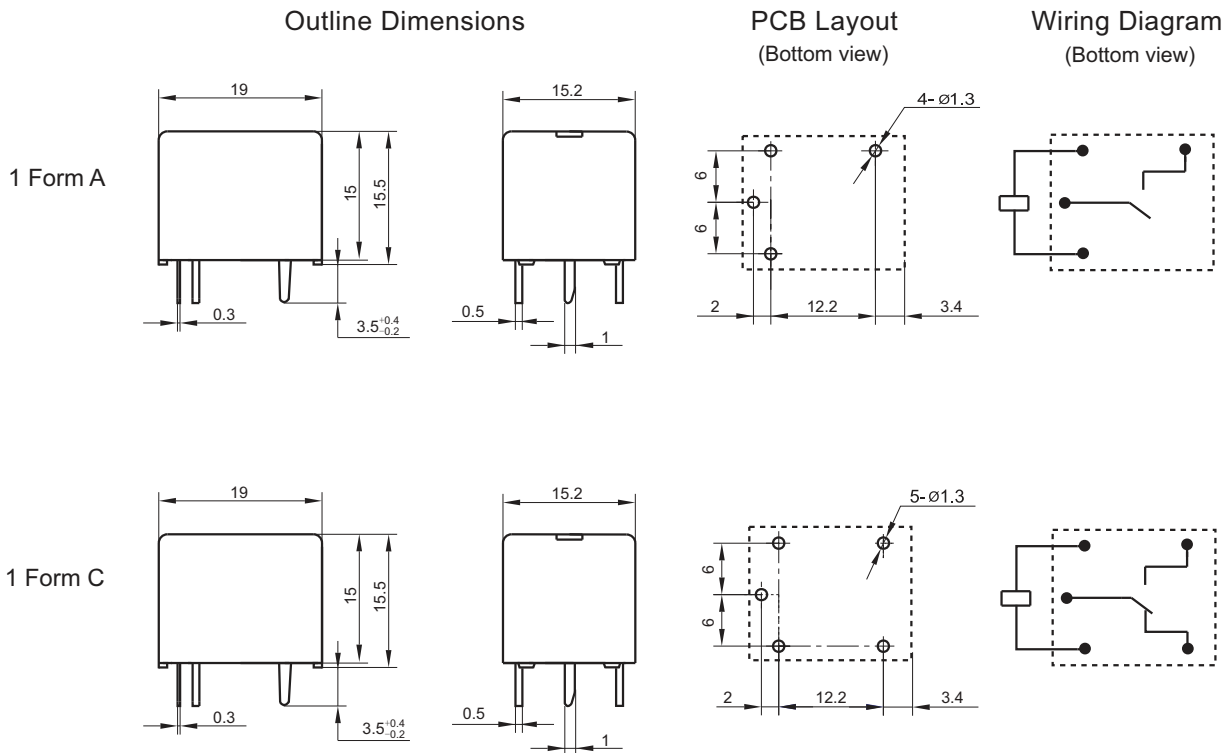

- Remark:** 1) In case of no tolerance shown in outline dimension: outline dimension ≤1mm, tolerance should be ±0.2mm; outline dimension >1mm and ≤5mm, tolerance should be ±0.3mm; outline dimension >5mm, tolerance should be ±0.4mm.
 2) The tolerance without indicating for PCB layout is always ±0.1mm.

CHARACTERISTIC CURVES

MAXIMUM SWITCHING POWER

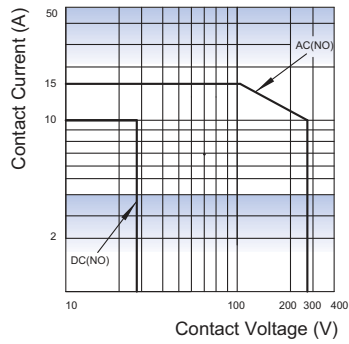

ENDURANCE CURVE

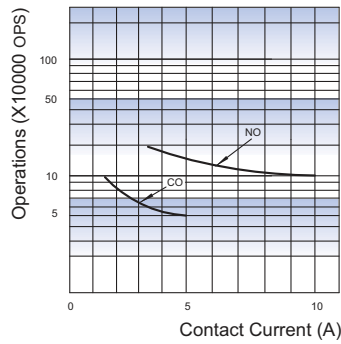

Test conditions:

NO, Resistive load, 277VAC/28VDC,
Flux proofed, Room temp., 1s on 9s off
CO, Resistive load, 250VAC,
Flux proofed, Room temp., 5s on 5s off.

COIL TEMPERATURE RISE

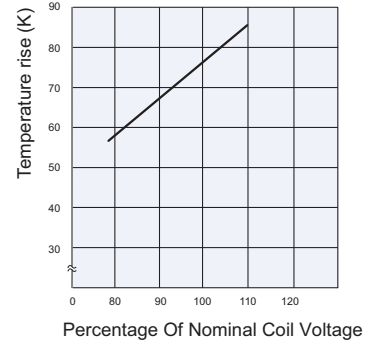

Testing conditions:

10A at 70°C.
Mounting distance: 10mm

Disclaimer

The specification is for reference only. See to "Terminology and Guidelines" for more information. Specifications subject to change without notice. We could not evaluate all the performance and all the parameters for every possible application. Thus the user should be in a right position to choose the suitable product for their own application. If there is any query, please contact Hongfa for the technical service. However, it is the user's responsibility to determine which product should be used only.

HF3F-L

SUBMINIATURE HIGH POWER LATCHING RELAY



File No.: E134517



File No.:40040757



File No.:CQC15002121475



Features

- Subminiature high power latching relay
- Low coil power
1 coil latching: approx. 0.4W
2 coils latching: approx. 0.8W
- 15A switching capability
- 1 Form A and 1 Form C configurations
- Subminiature, standard PCB layout
- Plastic sealed and flux proofed types available
- Environmental friendly product (RoHS compliant)
- Outline Dimensions: (19.0 x 15.2 x 15.5) mm

CONTACT DATA

Contact arrangement	1A	1C
Contact resistance	100mΩ max.(at 1A 6VDC)	
Contact material	AgSnO ₂	
Contact rating (Res. load)	10A 277VAC/30VDC	
Max. switching voltage	277VAC / 30VDC	
Max. switching current	15A	10A
Max. switching power	2770VA / 300W	
Mechanical endurance	1 x 10 ⁷ OPS	
Electrical endurance	1HT: 6 x 10 ³ OPS (15A 120VAC, Incandescent lamp, at 60°C, 1s on 59s off) 1 x 10 ⁴ OPS (10A 277VAC, Resistive load, at 60°C, 1s on 9s off) 2 x 10 ⁴ OPS (12A 277VAC, General use, at 70°C, 1s on 9s off)	

CHARACTERISTICS

Insulation resistance	100MΩ (at 500VDC)	
Dielectric strength	Between coil & contacts	2000VAC 1min
	Between open contacts	750VAC 1min
Set time (at nomi. volt.)	8ms max.	
Reset time (at nomi. volt.)	5ms max.	
Shock resistance	Functional	98m/s ²
	Destructive	980m/s ²
Vibration resistance	10Hz to 55Hz 1.5mm DA	
Humidity	5% to 85% RH	
Ambient temperature	-40°C to 85°C	
Termination	PCB	
Unit weight	Approx. 9g	
Construction	Plastic sealed, Flux proofed	

Notes: 1) For sealed type, the vent-hole cover should be closed.
2) The data shown above are initial values.

COIL

Coil power	1 coil latching: Approx. 0.4W 2 coils latching: Approx. 0.8W
------------	---

COIL DATA

at 23°C

1 coil latching

Nominal Voltage VDC	Set Voltage VDC max.	Reset Voltage VDC max.	Pulse Width (ms) min.	Max. Voltage VDC	Coil Resistance Ω
5	4.0	4.0	100	10	62.5x (1±10%)
6	4.8	4.8	100	12	90x (1±10%)
9	7.2	7.2	100	18	202.5x (1±10%)
12	9.6	9.6	100	24	360x (1±10%)
24	19.2	19.2	100	48	1440x (1±10%)
48	38.4	38.4	100	96	5760x (1±10%)

2 coils latching

Nominal Voltage VDC	Set Voltage VDC max.	Reset Voltage VDC max.	Pulse Width (ms) min.	Max. Voltage VDC	Coil Resistance Ω
5	4.0	4.0	100	10	31.5+31.5x (1±10%)
6	4.8	4.8	100	12	45+45x (1±10%)
9	7.2	7.2	100	18	101.5+101.5x (1±10%)
12	9.6	9.6	100	24	180+180x (1±10%)
24	19.2	19.2	100	48	720+720x (1±10%)
48	38.4	38.4	100	96	2880+2880x (1±10%)

SAFETY APPROVAL RATINGS

UL/CUL	NO:10A 277/250/125VAC, Resistive at 60°C NO:12A 277/250/125VAC, General use at 70°C NO: Standard ballast 5.5A 277/220/120VAC at 60°C NO: Electronic ballast 5A, 120VAC at 60°C NO: Electronic ballast 5A, 277VAC at 70°C*
	NO: Tungsten (incandescent) 15A 120VAC at 60°C NO: Tungsten (incandescent) 5A 277VAC at 60°C NO: 1/6HP 240/120VAC at 85°C NO: TV-10 125VAC at 70°C
VDE	NO: 10A 250VAC, Resistive, at 85°C NO/NC: 5A 250VAC, Resistive, at 85°C

- Notes: 1) All values unspecified are at room temperature.
2) Only typical loads are listed above. Other load specifications can be available upon request.
3) * These ratings are tested with zero crossing device.



HONGFA RELAY

ISO9001, ISO/TS16949, ISO14001, OHSAS18001, IECQ QC 080000 CERTIFIED

ORDERING INFORMATION

Type	HF3F-L / 12 -1H L1 T -R (XXX)	
Coil voltage	5, 6, 9, 12, 24, 48VDC	
Contact arrangement	1H:1 Form A	1Z:1 Form C
Sort	L1: 1 coil latching	L2: 2 coils latching
Contact material	T: AgSnO ₂	
Polarity	R: Reverse polarity	Nil: Standard polarity
Special code ³⁾	XXX: Customer special requirement	Nil: Standard

Notes: 1) Water cleaning or surface process is not suggested after the flux-proofed relays are assembled on PCB.

2) Flux-proofed relays can not be used in the environment with pollutants like H₂S, SO₂, NO₂, dust, etc.

3) The customer special requirement express as special code after evaluating by Hongfa.

OUTLINE DIMENSIONS, WIRING DIAGRAM AND PC BOARD LAYOUT

Unit: mm

Outline Dimensions

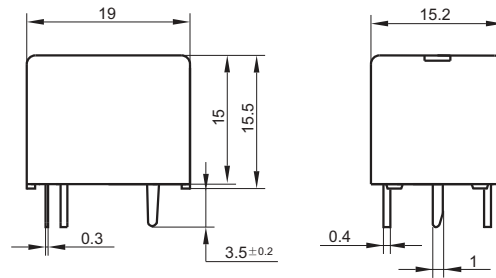

PCB Layout (Bottom view)

1 coil latching

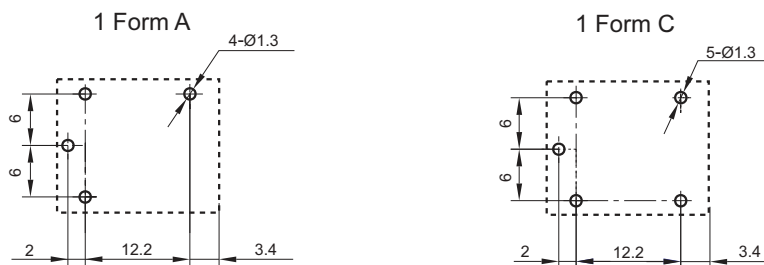

PCB Layout (Bottom view)

2 coils latching

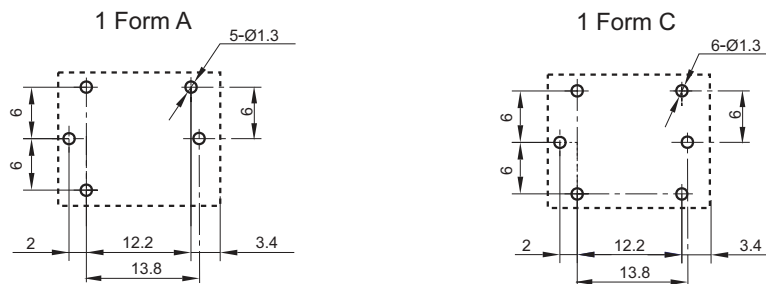

Remark: 1) In case of no tolerance shown in outline dimension: outline dimension $\leq 1\text{mm}$, tolerance should be $\pm 0.2\text{mm}$; outline dimension $> 1\text{mm}$ and $\leq 5\text{mm}$, tolerance should be $\pm 0.3\text{mm}$; outline dimension $> 5\text{mm}$, tolerance should be $\pm 0.4\text{mm}$.
 2) The tolerance without indicating for PCB layout is always $\pm 0.1\text{mm}$.

Wiring Diagram (Bottom view)

1 coil latching

Standard Polarity

Reverse Polarity

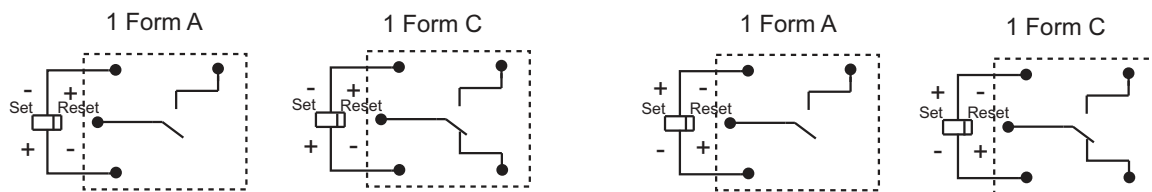

2 coils latching

Standard Polarity

Reverse Polarity

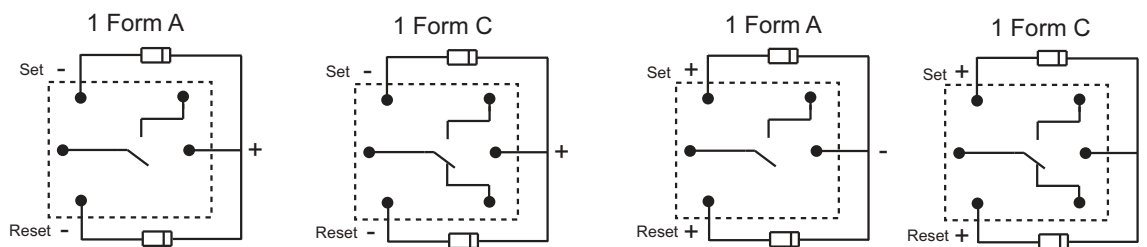

Notice

1. Relay is on the "reset" or "set" status when being released from stock, with the consideration of shock risen from transit and relay mounting, relay would be changed to "set" or "reset" status, therefore, when application (connecting the power supply), please reset the relay to "set" or "reset" status on request.
2. In order to maintain "set" or "reset" status, energized voltage to coil should reach the rated voltage, impulse width should be more than 100 ms. Do not energize voltage to "set" coil and "reset" coil simultaneously. And also long energized time (more than 1 min) should be avoided.
3. Keep the product away from strong magnetic field during transportation, storage and application, to avoid change of set/reset voltage.

Disclaimer

The specification is for reference only. See to "Terminology and Guidelines" for more information. Specifications subject to change without notice. We could not evaluate all the performance and all the parameters for every possible application. Thus the user should be in a right position to choose the suitable product for their own application. If there is any query, please contact Hongfa for the technical service. However, it is the user's responsibility to determine which product should be used only.

HF3FF-M

AUTOMOTIVE RELAY



Typical Applications

Anti-theft lock, Central door lock

Features

- 15A switching capability
- Subminiature, standard PCB layout
- 1 Form A & 1 Form C contact arrangement
- Plastic sealed and Flux proofed types available
- RoHS & ELV compliant

CHARACTERISTICS

Contact arrangement	1A, 1C
Voltage drop (initial) ¹⁾	Typ: 20mV (at 10A) Max.: 250mV (at 10A)
Max. continuous current ²⁾	10A
Max. switching current ³⁾	15A
Max. switching voltage	30VDC
Min.contact load	1A 6VDC
Electrical endurance	See "CONTACT DATA"
Mechanical endurance	1×10 ⁷ OPS (300OPS/min)
Initial insulation resistance	100MΩ (at 500VDC)
Dielectric strength ⁴⁾	Between contacts: 750VAC
	Between coil & contacts: 1500VAC
Operate time	Typ: 5ms
	Max.: 10ms (at nomi. vol.)

Release time ⁵⁾	Typ: 3ms Max.: 10ms
Ambient temperature	-40°C to 85°C
Vibration resistance ⁶⁾	10Hz to 55Hz 1.5mm DA
Shock resistance ⁶⁾	98m/s ²
Termination	PCB ⁷⁾
Construction	Plastic sealed, Flux proofed
Unit weight	Approx. 10g

- 1) Equivalent to the max. initial contact resistance is 100mΩ (at 1A 6VDC).
- 2) For NO contacts, measured when applying 100% rated voltage on coil.
- 3) At 23°C, 13.5VDC (100 cycles, resistive load).
- 4) 1min, leakage current less than 1mA.
- 5) The value is measured when voltage drops suddenly from nominal voltage to 0VDC and coil is not paralleled with suppression circuit.
- 6) When energized, opening time of NO contacts shall not exceed 100μs, when non-energized, opening time of NC contacts shall not exceed 100μs, meantime, NO contacts shall not be closed.
- 7) Since it is an environmental friendly product, please select lead-free solder when welding. The recommended soldering temperature and time is (250±3)°C, (5±0.3)s.

CONTACT DATA ¹⁾

at 23°C

Load voltage	Load type		Load current A			On/Off ratio		Electrical endurance OPS	Contact material	Load wiring diagram
			1C		1A	On s	Off s			
			NO	NC	NO					
13.5VDC	Resistive	Make	15	5	15	5	5	1×10 ⁵	HF3FF-M/M1: AgSnO ₂ HF3FF-M2: AgNi	
		Break	15	5	15	5	5			

1) When the load voltage is at 24VDC or higher, or the applications conditions are different from the table above, please submit the detailed application conditions to Hongfa to get more support.



HONGFA RELAY

ISO9001, ISO/TS16949, ISO14001, OHSAS18001, IECQ QC 080000 CERTIFIED

COIL DATA

at 23°C

Type	Nominal voltage VDC	Pick-up Voltage VDC max.	Drop-out Voltage VDC min.	Coil resistance $\times(1\pm 10\%)\Omega$	Power consumption W	Max. allowable overdrive voltage ¹⁾ VDC	
						at 23°C	at 85°C
HF3FF-M	9	6.75	0.90	180	0.45	11.7	10.8
	12	9.00	1.20	320	0.45	15.6	14.4
	24	18.00	2.40	1280	0.45	31.2	28.8
HF3FF-M1	9	5.85	0.65	126	0.64	11.3	10.3
	12	7.80	0.90	225	0.64	15.0	13.8
	24	15.6	1.80	900	0.64	30.0	27.6
HF3FF-M2	9	5.15	0.60	100	0.80	10.8	9.9
	12	6.80	0.80	180	0.80	14.4	13.2
	24	13.70	1.60	720	0.80	28.8	26.4

1) Max. allowable overdrive voltage is stated with no load applied.

ORDERING INFORMATION

		HF3FF-M /		012	-1H	S	(XXX)
Type	HF3FF-M: 0.45W HF3FF-M1: 0.64W HF3FF-M2: 0.80W						
Coil voltage	009: 9VDC	012: 12VDC	024: 24VDC				
Contact arrangement	1H: 1 Form A	1Z: 1 Form C					
Construction	S: Plastic sealed ¹⁾	Nil: Flux proofed					
Special code²⁾	XXX: Customer special requirement	Nil: Standard					

Notes: 1) If washing or surface treatment is required after the relay is assembled on PCB, please provide with the conditions in details for our confirmation or our recommendation with suitable products.

2) The customer special requirement express as special code after evaluating by Hongfa.

OUTLINE DIMENSIONS, WIRING DIAGRAM AND PC BOARD LAYOUT

Unit: mm

Outline Dimensions (1 Form A / 1 Form C)

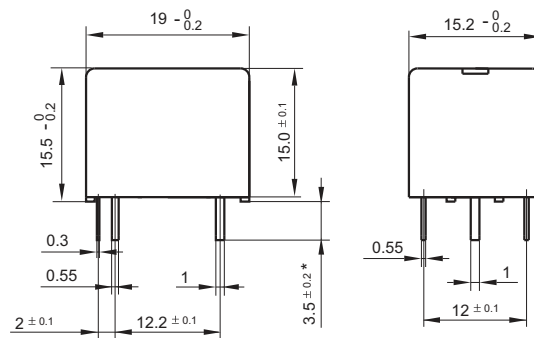

Wiring Diagram (Bottom view)



PCB Layout (Bottom view)

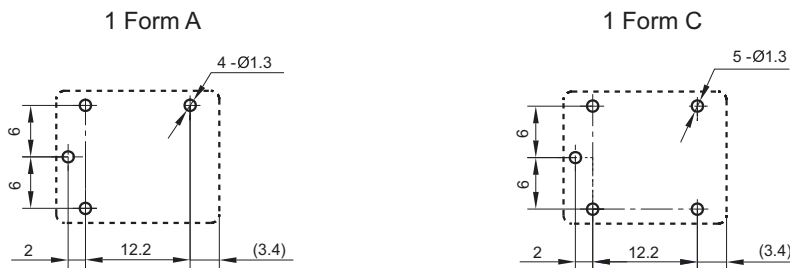

Remark: 1) * The additional tin top is max. 1mm.
 2) The tolerance without indicating for PCB layout is always ± 0.1 mm.

CHARACTERISTIC CURVES

COIL TEMPERATURE RISE

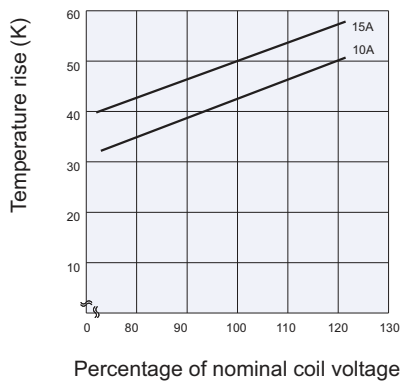

ENDURANCE CURVE

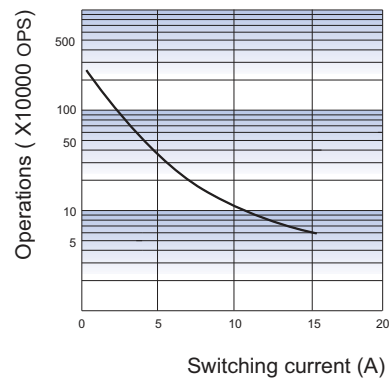

Disclaimer

The specification is for reference only. See to "Terminology and Guidelines" for more information. Specifications subject to change without notice. In case there is specific criterion (such as mission profile, technical specification, PPAP etc.) checked and agreed by and between customer and Hongfa, this specific criterion should be taken as standard regarding any requirement on Hongfa product.

We could not evaluate all the performance and all the parameters for every possible application. Thus the user should be in a right position to choose the suitable product for their own application. If there is any query, please contact Hongfa for the technical service. However, it is the user's responsibility to determine which product should be used only.

© Xiamen Hongfa Electroacoustic Co., Ltd. All rights of Hongfa are reserved.

HF7FF

SUBMINIATURE INTERMEDIATE POWER RELAY



File No.:E134517



File No.:CQC09002028260



Features

- 10A switching capability
- 1 Form A and 1 Form C configurations
- Plastic sealed and flux proofed types available
- UL insulation system: Class F available
- Environmental friendly product (RoHS compliant)
- Outline Dimensions: (22.5 x 16.5 x 16.5) mm

CONTACT DATA

Contact arrangement	1A, 1C
Contact resistance	100mΩ max.(at 1A 6VDC)
Contact material	AgSnO ₂ , AgCe
Contact rating (Res. load)	5A 250VAC/30VDC 10A 250VAC/28VDC
Max. switching voltage	250VAC / 30VDC
Max. switching current	10A
Max. switching power	2400VA / 280W
Mechanical endurance	1 x 10 ⁷ OPS
Electrical endurance	1HT, 1ZT type: 1 x 10 ⁴ ops (10A 250VAC, Resistive load, Room temp., 1s on 9s off) 1H, 1Z type: 1 x 10 ⁴ ops (5A 250VAC, Resistive load, Room temp., 1s on 9s off)

CHARACTERISTICS

Insulation resistance	100MΩ (at 500VDC)	
Dielectric strength	Between coil & contacts	1500VAC 1min
	Between open contacts	750VAC 1min
Operate time (at nomi. volt.)	10ms max.	
Release time (at nomi. volt.)	5ms max.	
Shock resistance	Functional	98m/s ²
	Destructive	980m/s ²
Vibration resistance	10Hz to 55Hz 1.5mm DA	
Humidity	5% to 85% RH	
Ambient temperature	-40°C to 70°C	
Termination	PCB	
Unit weight	Approx. 9.5g	
Construction	Plastic sealed, Flux proofed	

- Notes: 1) The data shown above are initial values.
2) Please find coil temperature curve in the characteristic curves below.
3) UL insulation system: Class F, Class B, Class A.

COIL

Coil power	5VDC to 24VDC: Approx. 360mW 48VDC: Approx. 510mW
------------	--

COIL DATA

at 23°C

Nominal Voltage VDC	Pick-up Voltage VDC max.	Drop-out Voltage VDC min.	Max. Voltage VDC *	Coil Resistance Ω
3	2.40	0.3	3.6	25 x (1±10%)
5	4.00	0.5	6.0	70 x (1±10%)
6	4.80	0.6	7.2	100 x (1±10%)
9	7.20	0.9	10.8	225 x (1±10%)
12	9.60	1.2	14.4	400 x (1±10%)
18	14.4	1.8	21.6	900 x (1±10%)
24	19.2	2.4	28.8	1600 x (1±10%)
48	38.4	4.8	57.6	4500 x (1±10%)

Notes: *Maximum voltage refers to the maximum voltage which relay coil could endure in a short period of time.

SAFETY APPROVAL RATINGS

UL/CUL (AgCe)	1 Form C	NO: 10A 277VAC NO/NC: 5A 277VAC NO: 5A 30VDC NC: 2FLA 4LRA 120VAC
	1 Form A	10A 277VAC 6A 30VDC
UL/CUL (AgSnO ₂)	1 Form C	12A 277VAC 12A 28VDC
	1 Form A	12A 277VAC 12A 28VDC

- Notes: 1) All values unspecified are at room temperature.
2) Only typical loads are listed above. Other load specifications can be available upon request.



HONGFA RELAY

ISO9001, ISO/TS16949, ISO14001, OHSAS18001, IECQ QC 080000 CERTIFIED

ORDERING INFORMATION

Type	HF7FF / 012 -1H T S F (XXX)					
Coil voltage	3, 5, 6, 9, 12, 18, 24, 48VDC					
Contact arrangement	1H: 1 Form A		1Z: 1 Form C			
Contact material	T: AgSnO ₂ (10A)		Nil: AgCe (5A)			
Construction ¹⁾	S: Plastic sealed		Nil: Flux proofed			
Insulation standard	F: Class F		B: Class B		Nil: Class A	
Special code ⁴⁾	XXX: Customer special requirement			Nil: Standard		

- Notes:** 1) Under the ambience with dangerous gas like H₂S, SO₂ or NO₂, plastic sealed type is recommended; Please test the relay in real applications.
If the ambience allows, flux proofed type is preferentially recommended.
- 2) Contact is recommended for suitable condition and specifications if water cleaning or surface process is involved in assembling relays on PCB.
- 3) If the application belongs to inductive load, AgSnO₂In₂O₃ contact material is recommended. Please add a special suffix (325) to stand for this special contact material in the ordering information.
- 4) The customer special requirement express as special code after evaluating by Hongfa.

OUTLINE DIMENSIONS, WIRING DIAGRAM AND PC BOARD LAYOUT

Unit: mm

Outline Dimensions

PCB Layout (Bottom view)

Wiring Diagram (Bottom view)

1 Form A

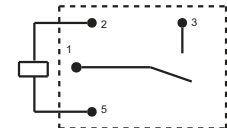
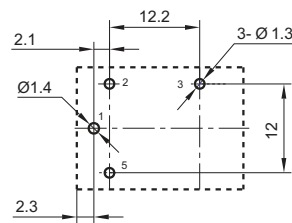
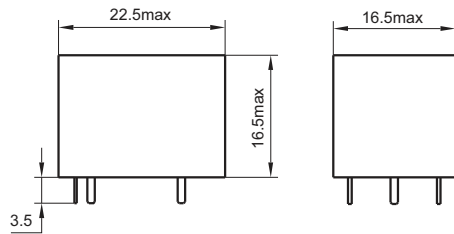

1 Form C

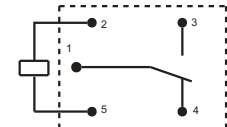
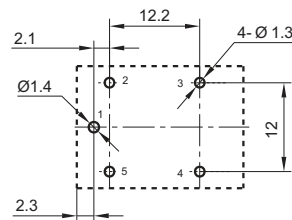
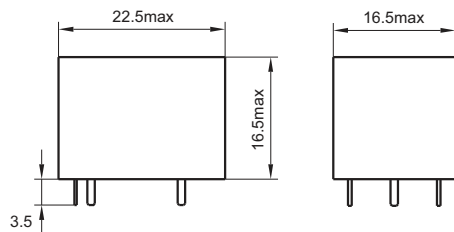

- Remark: 1) In case of no tolerance shown in outline dimension: outline dimension ≤ 1 mm, tolerance should be ± 0.2 mm; outline dimension > 1 mm and ≤ 5 mm, tolerance should be ± 0.3 mm; outline dimension > 5 mm, tolerance should be ± 0.4 mm.
- 2) The tolerance without indicating for PCB layout is always ± 0.1 mm.

CHARACTERISTIC CURVES

MAXIMUM SWITCHING POWER

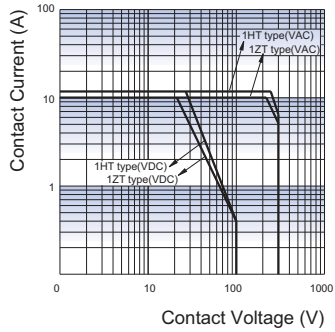

ENDURANCE CURVE

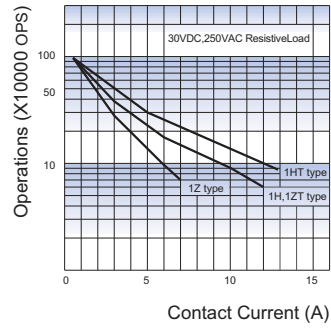

Test conditions:

NO, Resistive load, Flux proofed,
Room temp., 1s on 9s off.

COIL TEMPERATURE RISE

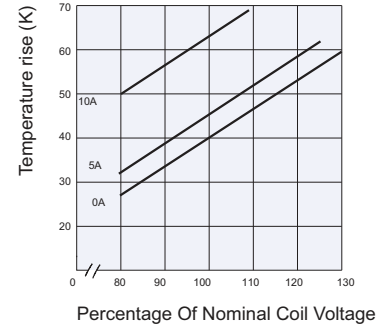

Disclaimer

The specification is for reference only. See to "Terminology and Guidelines" for more information. Specifications subject to change without notice. We could not evaluate all the performance and all the parameters for every possible application. Thus the user should be in a right position to choose the suitable product for their own application. If there is any query, please contact Hongfa for the technical service. However, it is the user's responsibility to determine which product should be used only.

HF7FD

SUBMINIATURE HIGH POWER RELAY



File No.:E134517



File No.: 40008374



File No.:CQC09002037921



Features

- 12A switching capability
- Ambient temperature meets 105°C
- High performance, Low profile
- Product in accordance to IEC 60335-1 available
- 2kV dielectric strength (between coil and contacts)
- UL94, V-0, CTI250 flammability class
- Double pins type available
- 1 Form A and 1 Form C configurations
- UL insulation system: Class F available
- Environmental friendly product (RoHS compliant)
- Outline Dimensions: (22.0 x 16.0 x 16.4) mm

CONTACT DATA

Contact arrangement	1A	1C
Contact resistance	100mΩ max.(at 1A 24VDC)	
Contact material	AgSnO ₂ , AgCdO	
Contact rating (Res. load)	16A 250VAC 12A 250VAC 10A 250VAC	12A 125VAC NO: 10A 250VAC NC: 7A 250VAC
Max. switching voltage	250VAC / 28VDC	
Max. switching current	16A	10A
Max. switching power	4000VA / 280W	2500VA / 196W
Mechanical endurance	1 x 10 ⁷ OPS	
Electrical endurance (See approval reports for more details)	1A	Flux proofed: 1 x 10 ⁵ OPS Plastic sealed: 5 x 10 ⁴ OPS (10A 277VAC, Resistive load, Room temp, 1s on 9s off)
	1C	Flux proofed: 5x 10 ⁴ OPS Plastic sealed: NO: 5 x 10 ⁴ OPS NC: 1x 10 ⁴ OPS (7A 277VAC, Resistive load, Room temp, 1s on 9s off)

COIL

Coil power Approx. 360mW

COIL DATA

at 23°C

Nominal Voltage VDC	Pick-up Voltage VDC max.	Drop-out Voltage VDC min.	Max. Voltage VDC*	Coil Resistance Ω
3	2.25	0.3	3.9	25 x (1±10%)
5	3.75	0.5	6.5	70 x (1±10%)
6	4.50	0.6	7.8	100 x (1±10%)
9	6.75	0.9	11.7	225 x (1±10%)
12	9.00	1.2	15.6	400 x (1±10%)
18	13.5	1.8	23.4	900 x (1±10%)
24	18.0	2.4	31.2	1600 x (1±15%)
48	36.0	4.8	62.4	6400 x (1±15%)

Notes: *Maximum voltage refers to the maximum voltage which relay coil could endure in a short period of time.

CHARACTERISTICS

Insulation resistance	100MΩ (at 500VDC)	
Dielectric strength	Between coil & contacts	2000VAC 1min
	Between open contacts	750VAC 1min
Operate time (at nomi. volt.)	10ms max.	
Release time (at nomi. volt.)	5ms max.	
Humidity	5% to 85% RH	
Shock resistance	Functional	98m/s ²
	Destructive	980m/s ²
Ambient temperature	HF7FD: -40°C to 85°C HF7FD-T: -40°C to 105°C	
Vibration resistance	10Hz to 55Hz 1.5mm DA	
Termination	PCB	
Unit weight	Approx. 9.5g	
Construction	Plastic sealed, Flux proofed	

- Notes:** 1) The data shown above are initial values.
2) Please find coil temperature curve in the characteristic curves below.
3) UL insulation system: Class F, Class B.

SAFETY APPROVAL RATINGS

UL/CUL	1 Form A	HF7FD	12A 250VAC (at 85°C, AgSnO ₂ , Double pin) 10A 277VAC 10A 28VDC
		HF7FD-T (AgSnO ₂)	16A 250VAC (at 40°C) 10A 250VAC (at 105°C) 8A 250VAC (at 105°C) 1/2HP 125VAC (at 40°C) 1/2HP 250VAC (at 40°C)
VDE	1 Form A	12A 125VAC 7A 277VAC 7A 28VDC	
	1 Form C	12A 250VAC (AgSnO ₂ , Double pin) 10A 250VAC 7A 250VAC	

- Notes:** 1) All values unspecified are at room temperature.
2) Only typical loads are listed above. Other load specifications can be available upon request.



HONGFA RELAY

ISO9001, ISO/TS16949, ISO14001, OHSAS18001, IECQ QC 080000 CERTIFIED

ORDERING INFORMATION

HF7FD / 012 -1H P S T G F (XXX)

Type HF7FD: 85°C, HF7FD-T: 105°C

Coil voltage 3, 5, 6, 9, 12, 18, 24, 48VDC

Contact arrangement 1H: 1 Form A 1Z: 1 Form C

Pin version P: Double pins type Nil: Single pin type

Construction¹⁾ S: Plastic sealed Nil: Flux proofed

Contact material T: AgSnO₂ Nil: AgCdO

Contact plating G: Gold plated Nil: No gold plated

Insulation standard F: Class F Nil: Class B

Special code⁴⁾ XXX: Customer special requirement Nil: Standard

- Notes:** 1) Under the ambience with dangerous gas like H₂S, SO₂ or NO₂, plastic sealed type is recommended; Please test the relay in real applications. If the ambience allows, flux proofed type is preferentially recommended.
 2) Contact is recommended for suitable condition and specifications if water cleaning or surface process is involved in assembling relays on PCB.
 3) If plastic sealed type is selected for cleaning purpose, the vent-hole cover should be excised after cleaning.
 4) The customer special requirement express as special code after evaluating by Hongfa.

OUTLINE DIMENSIONS, WIRING DIAGRAM AND PC BOARD LAYOUT

Unit: mm

Outline Dimensions

PCB Layout
(Bottom view)

Wiring Diagram
(Bottom View)

1 Form A (Single pin type)

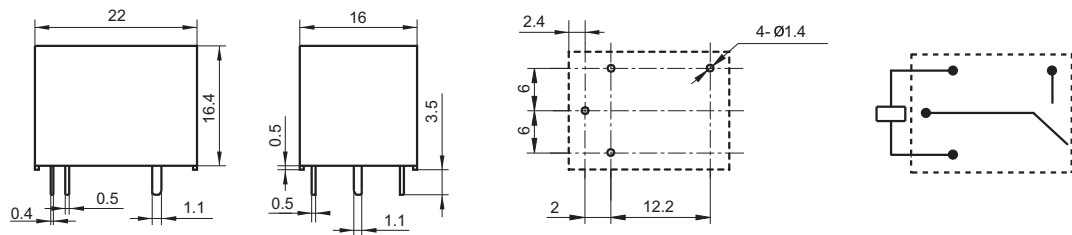

1 Form C (Single pin type)

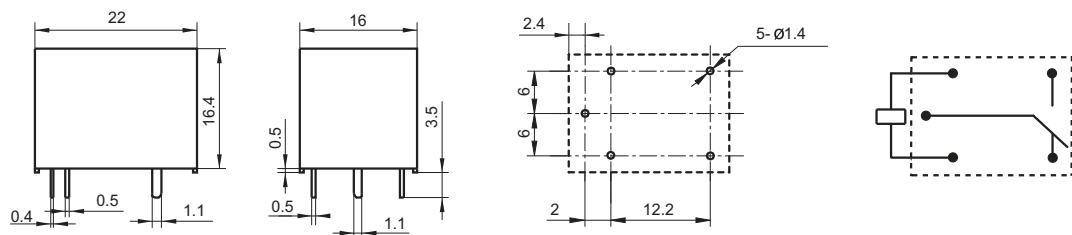

OUTLINE DIMENSIONS, WIRING DIAGRAM AND PC BOARD LAYOUT

Unit: mm

Outline Dimensions

PCB Layout (Bottom view)

Wiring Diagram (Bottom View)

1 Form A (Double pins type)

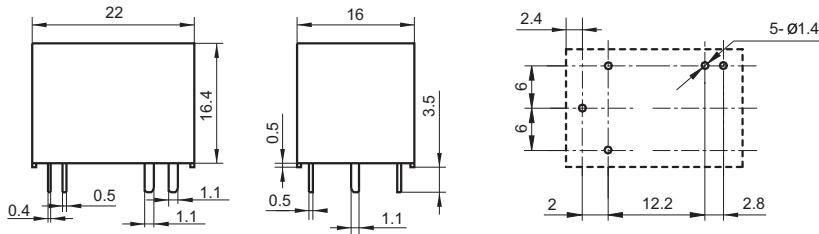

1 Form C (Double pins type)

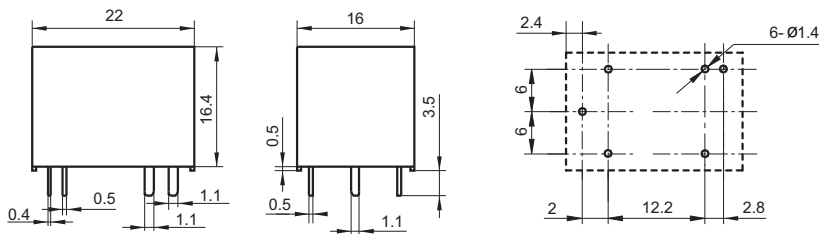

- Remark: 1) In case of no tolerance shown in outline dimension: outline dimension $\leq 1\text{mm}$, tolerance should be $\pm 0.2\text{mm}$; outline dimension $> 1\text{mm}$ and $\leq 5\text{mm}$, tolerance should be $\pm 0.3\text{mm}$; outline dimension $> 5\text{mm}$, tolerance should be $\pm 0.4\text{mm}$.
 2) The tolerance without indicating for PCB layout is always $\pm 0.1\text{mm}$.
 3) Tin-dipped joint is tolerable after terminal tin-dipping as long as the terminal length including the joint is less than 4.0mm.

CHARACTERISTIC CURVES

MAXIMUM SWITCHING POWER

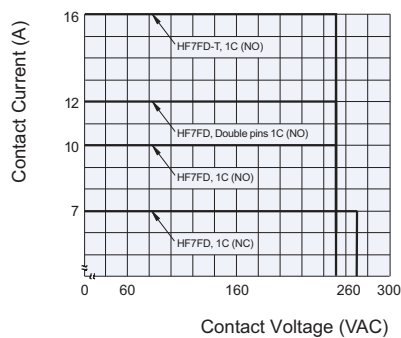

COIL TEMPERATURE RISE

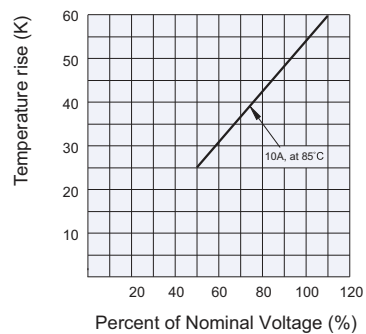

Disclaimer

The specification is for reference only. See to "Terminology and Guidelines" for more information. Specifications subject to change without notice. We could not evaluate all the performance and all the parameters for every possible application. Thus the user should be in a right position to choose the suitable product for their own application. If there is any query, please contact Hongfa for the technical service. However, it is the user's responsibility to determine which product should be used only.

© Xiamen Hongfa Electroacoustic Co., Ltd. All rights of Hongfa are reserved.

HF21FF

SUBMINIATURE HIGH POWER RELAY



File No.:E133481



Features

- 15A switching capability
- 1 Form A, 1 Form B and 1 Form C configurations
- Standard PCB layout
- Plastic sealed and dust protected types available
- UL insulation system: Class F available
- Environmental friendly product (RoHS compliant)
- Outline Dimensions: (20.2 x 16.5 x 20.2) mm

CONTACT DATA

Contact arrangement	1A, 1B	1C
Contact resistance	100mΩ max.(at 1A 6VDC)	
Contact material	AgSnO ₂	
Contact rating	15A 120VAC	10A 120VAC/24VDC
Max. switching voltage	120VAC / 30VDC	
Max. switching current	15A	10A
Max. switching power	1800VA / 240W	
Mechanical endurance	1 x 10 ⁷ OPS	
Electrical endurance	1H type: 1 x 10 ⁵ OPS (15A 120VAC, Resistive load, Room temp., 1s on 9s off)	

CHARACTERISTICS

Insulation resistance	100MΩ (at 500VDC)	
Dielectric strength	Between coil & contacts	1500VAC 1min
	Between open contacts	750VAC 1min
Operate time (at nomi. volt.)	10ms max.	
Release time (at nomi. volt.)	5ms max.	
Shock resistance	Functional	98m/s ²
	Destructive	980m/s ²
Vibration resistance	10Hz to 55Hz 1.5mm DA	
Humidity	5% to 85% RH	
Ambient temperature	-40°C to 70°C	
Termination	PCB	
Unit weight	Approx. 13g	
Construction	Plastic sealed, Dust protected	

- Notes:** 1) The data shown above are initial values.
2) Please find coil temperature curve in the characteristic curves below.
3) UL insulation system: Class F, Class B.

COIL

Coil power	5VDC to 24VDC: Approx. 360mW; 48VDC: Approx. 530mW
------------	---

COIL DATA

at 23°C

Nominal Voltage VDC	Pick-up Voltage VDC max.	Drop-out Voltage VDC min.	Max. Voltage VDC *	Coil Resistance Ω
5	3.75	0.5	6.5	70 x (1±10%)
6	4.50	0.6	7.8	100 x (1±10%)
9	6.75	0.9	11.7	225 x (1±10%)
12	9.00	1.2	15.6	400 x (1±10%)
18	13.5	1.8	23.4	900 x (1±10%)
24	18.0	2.4	31.2	1600 x (1±15%)
48	36.0	4.8	62.4	4500 x (1±15%)

Notes: *Maximum voltage refers to the maximum voltage which relay coil could endure in a short period of time.

SAFETY APPROVAL RATINGS

UL/CUL	Configuration	Rating
UL/CUL	1 Form C	10A 120VAC
	1 Form A	15A 120VAC TV-5 120VAC
	1 Form B	15A 120VAC 1800VA at 25°C, Ballast 6.5A 277VAC 1800VA at 25°C, Ballast
	1 Form B F type	8.3A 120VAC 1000VA at 90°C, Ballast 3.6A 277VAC 1000VA at 90°C, Ballast

- Notes:** 1) All values unspecified are at room temperature.
2) Only typical loads are listed above. Other load specifications can be available upon request.



HONGFA RELAY

ISO9001, ISO/TS16949, ISO14001, OHSAS18001, IECQ QC 080000 CERTIFIED

ORDERING INFORMATION

Type	HF21FF / 012 -1H S T F (XXX)		
Coil voltage	5, 6, 9, 12, 18, 24, 48VDC		
Contact arrangement	1H: 1 Form A	1D: 1 Form B	1Z: 1 Form C
Construction ¹⁾	S: Plastic sealed	Nil: Dust protected	
Contact material	T: AgSnO ₂		
Insulation standard	F: Class F	Nil: Class B	
Special code ³⁾	XXX: Customer special requirement	Nil: Standard	

Notes: 1) Under the ambience with dangerous gas like H₂S, SO₂ or NO₂, plastic sealed type is recommended; Please test the relay in real applications. If the ambience allows, dust protected type is preferentially recommended.

2) Contact is recommended for suitable condition and specifications if water cleaning or surface process is involved in assembling relays on PCB.

3) The customer special requirement express as special code after evaluating by Hongfa.

OUTLINE DIMENSIONS, WIRING DIAGRAM AND PC BOARD LAYOUT

Unit: mm

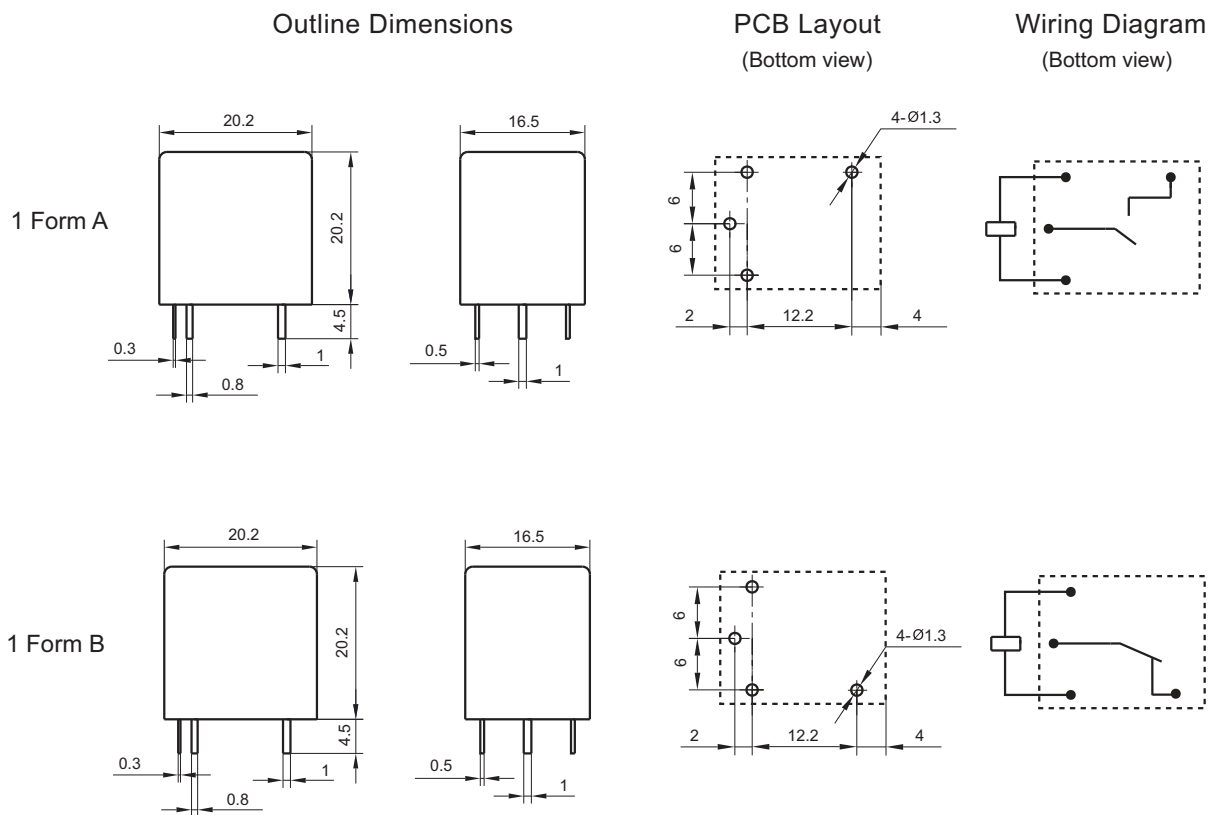

OUTLINE DIMENSIONS, WIRING DIAGRAM AND PC BOARD LAYOUT

Unit: mm

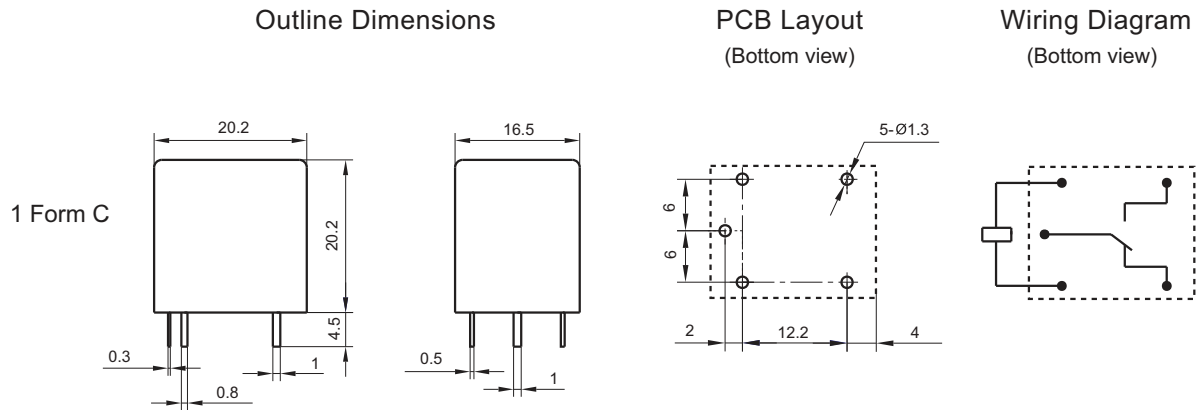

Remark: 1) In case of no tolerance shown in outline dimension: outline dimension $\leq 1\text{mm}$, tolerance should be $\pm 0.2\text{mm}$; outline dimension $> 1\text{mm}$ and $\leq 5\text{mm}$, tolerance should be $\pm 0.3\text{mm}$; outline dimension $> 5\text{mm}$, tolerance should be $\pm 0.4\text{mm}$.
 2) The tolerance without indicating for PCB layout is always $\pm 0.1\text{mm}$.

CHARACTERISTIC CURVES

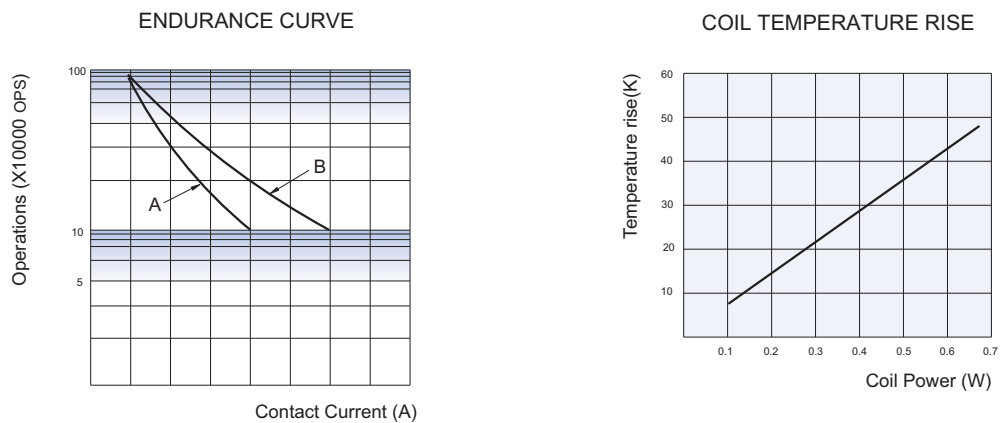

Notes:

1. Curve A: 1ZT type
Curve B: 1HT type
2. Test conditions:
Resistive load, Room temp. 1s on 9s off

Disclaimer

The specification is for reference only. See to "Terminology and Guidelines" for more information. Specifications subject to change without notice. We could not evaluate all the performance and all the parameters for every possible application. Thus the user should be in a right position to choose the suitable product for their own application. If there is any query, please contact Hongfa for the technical service. However, it is the user's responsibility to determine which product should be used only.

© Xiamen Hongfa Electroacoustic Co., Ltd. All rights of Hongfa are reserved.

HF152F

SUBMINIATURE HIGH POWER RELAY



File No.: E134517



File No.: 40017837



File No.: CQC09002034520



Features

- 20A switching capability
- TV-8 125VAC
- Surge voltage up to 6kV (between coil and contacts)
- Thermal class F: standard type (at 85°C)
- Ambient temperature meets 105°C
- Product in accordance to IEC 60335-1 available
- 1 Form C and 1 Form A configurations available
- Plastic sealed and dust protected types available
- UL insulation system: Class F available
- Environmental friendly product (RoHS compliant)
- Outline Dimensions: (21.0 x 16.0 x 20.6) mm

CONTACT DATA

Contact arrangement	1A	1C
Contact resistance	100mΩ max.(at 1A 24VDC)	
Contact material	AgSnO ₂ , AgNi	
Contact rating (Res. load)	20A 125VAC 17A 277VAC 7A 400VAC	16A 250VAC 7A 400VAC (NO)
Max. switching voltage	400VAC	400VAC (NO)
Max. switching current	20A	16A
Max. switching power	4700VA	4000VA
Mechanical endurance	1 x 10 ⁷ OPS	
Electrical endurance	1 x 10 ⁵ OPS (16A 250VAC, Resistive load, at 85°C, 1s on 9s off) 5 x 10 ⁴ OPS (NO, 16A 250VAC, Resistive load, Room temp., 1s on 9s off) 5 x 10 ⁴ OPS (NC, 10A 250VAC, Resistive load, Room temp., 1s on 9s off)	

Notes: For plastic sealed type, the venting-hole should be opened in electrical endurance test.

CHARACTERISTICS

Insulation resistance	100MΩ (at 500VDC)	
Dielectric strength	Between coil & contacts	2500VAC 1min
	Between open contacts	1000VAC 1min
Surge voltage(between coil & contacts)	6kV (1.2 / 50μs)	
Operate time (at nomi. volt.)	10ms max.	
Release time (at nomi. volt.)	5ms max.	
Shock resistance	Functional	98m/s ²
	Destructive	980m/s ²
Vibration resistance	10Hz to 55Hz 1.5mm DA	
Humidity	5% to 85% RH	
Ambient temperature	HF152F: -40°C to 85°C HF152F-T: -40°C to 105°C	
Termination	PCB	
Unit weight	Approx. 14g	
Construction	Plastic sealed, Dust protected	

- Notes:** 1) The data shown above are initial values.
2) Please find coil temperature curve in the characteristic curves below.
3) UL insulation system: Class F

COIL DATA

at 23°C

Nominal Voltage VDC	Pick-up Voltage VDC max.	Drop-out Voltage VDC min.	Max. Voltage VDC*	Coil Resistance Ω
3	2.25	0.3	3.9	25 x (1±10%)
5	3.75	0.5	6.5	70 x (1±10%)
6	4.50	0.6	7.8	100 x (1±10%)
9	6.75	0.9	11.7	225 x (1±10%)
12	9.00	1.2	15.6	400 x (1±10%)
18	13.5	1.8	23.4	900 x (1±10%)
24	18.0	2.4	31.2	1600 x (1±10%)
48	36.0	4.8	62.4	6400 x (1±10%)

Notes: *Maximum voltage refers to the maximum voltage which relay coil could endure in a short period of time.

COIL

Coil power Approx. 360mW

SAFETY APPROVAL RATINGS

UL/CUL	AgNi	20A 125VAC NO/NC: 17A/15A 277VAC	
	AgSnO ₂	20A 125VAC TV-8 125VAC NO: 16A 250VAC at 105°C NO: 1HP 250VAC	
VDE	AgSnO ₂	1 Form A	16A 250VAC 7A 400VAC
		1 Form C	NO: 16A 250VAC NC: 7A 250VAC

- Notes:** 1) All values unspecified are at room temperature.
2) Only typical loads are listed above. Other load specifications can be available upon request.



HONGFA RELAY

ISO9001, ISO/TS16949, ISO14001, OHSAS18001, IECQ QC 080000 CERTIFIED

ORDERING INFORMATION

	HF152F / 012 -1Z P S T G Q (XXX)	
Type	HF152F: 85°C, HF152F-T: 105°C	
Coil voltage	3, 5, 6, 9, 12, 18, 24, 48VDC	
Contact arrangement	1H: 1 Form A	1Z: 1 Form C
Pin version	P: Double pins	Nil: Single pin
Construction ¹⁾	S: Plastic sealed	Nil: Dust protected
Contact material	T: AgSnO ₂	Nil: AgNi
Contact plating	G: Gold plated	Nil: No gold plated
Contact capacity	Q: High capacity type 16A 250VAC, at 105°C (Only for HF152F-T) Nil: Standard type	
Special code ⁴⁾	XXX: Customer special requirement	Nil: Standard

- Notes:** 1) Under the ambience with dangerous gas like H₂S, SO₂ or NO₂, plastic sealed type is recommended; Please test the relay in real applications. If the ambience allows, dust protected type is preferentially recommended.
 2) Contact is recommended for suitable condition and specifications if water cleaning or surface process is involved in assembling relays on PCB.
 3) If plastic sealed type is selected for cleaning purpose, the vent-hole cover should be excised after cleaning.
 4) The customer special requirement express as special code after evaluating by Hongfa.
 5) HF152F-T is only available for AgSnO₂ contact.

OUTLINE DIMENSIONS, WIRING DIAGRAM AND PC BOARD LAYOUT

Unit: mm

Single pin version

Outline Dimensions

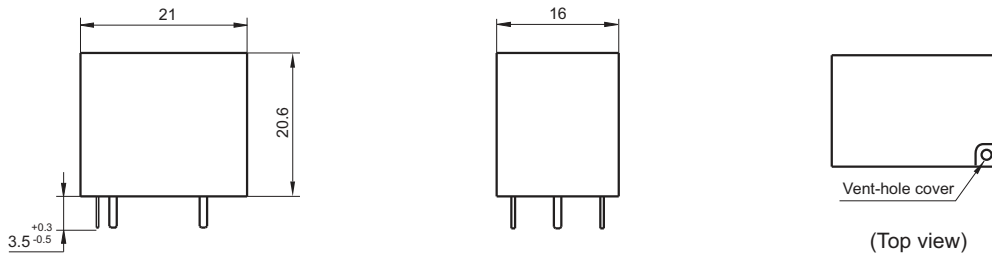

Wiring Diagram

(Bottom view)



PCB Layout

(Bottom view)



OUTLINE DIMENSIONS, WIRING DIAGRAM AND PC BOARD LAYOUT

Unit: mm

Double pin version

Outline Dimensions

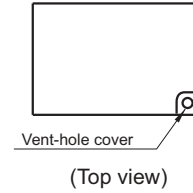
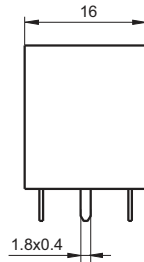
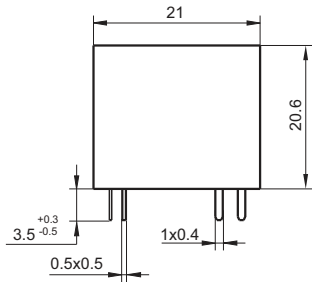

Wiring Diagram (Bottom view)

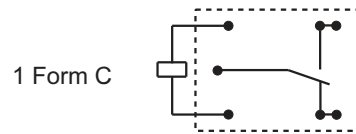
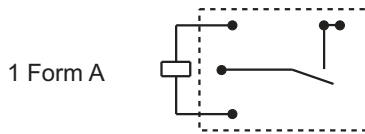

PCB Layout (Bottom view)

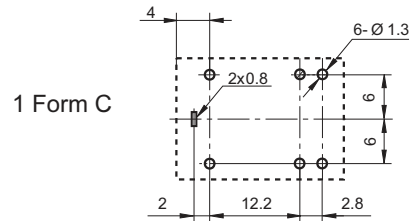
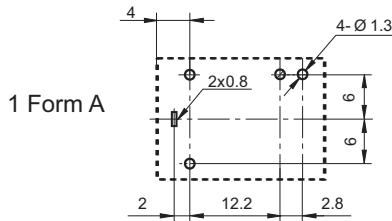

Remark: 1) In case of no tolerance shown in outline dimension: outline dimension $\leq 1\text{mm}$, tolerance should be $\pm 0.2\text{mm}$; outline dimension $> 1\text{mm}$ and $\leq 5\text{mm}$, tolerance should be $\pm 0.3\text{mm}$; outline dimension $> 5\text{mm}$, tolerance should be $\pm 0.4\text{mm}$.
2) The tolerance without indicating for PCB layout is always $\pm 0.1\text{mm}$.

CHARACTERISTIC CURVES

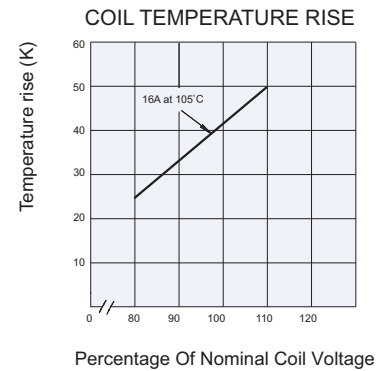
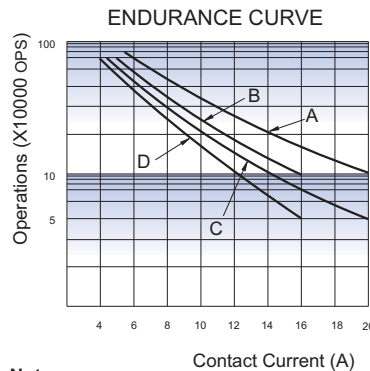
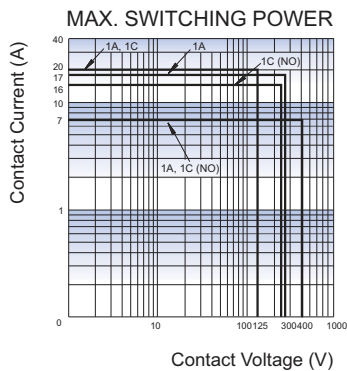

Notes:

- Curve A:1H type, Curve B:1H type, Curve C:1Z type, Curve D:1Z type
- Test conditions:
Curve A: 20A 125VAC, Resistive load, Room temp., 1s on 9s off
Curve B: 16A 250VAC, Resistive load, at 85°C, 1s on 9s off
Curve C: NO, 20A 125VAC, Resistive load, Room temp., 1s on 9s off
Curve D: NO, 16A 250VAC, Resistive load, at 85°C, 1s on 9s off

Disclaimer

The specification is for reference only. See to "Terminology and Guidelines" for more information. Specifications subject to change without notice. We could not evaluate all the performance and all the parameters for every possible application. Thus the user should be in a right position to choose the suitable product for their own application. If there is any query, please contact Hongfa for the technical service. However, it is the user's responsibility to determine which product should be used only.

HF152FD

SUBMINIATURE HIGH POWER RELAY



File No.: E134517



File No.: 40031203



File No.: CQC12002083404



Features

- 20A switching capability
- Ambient temperature meets 105°C
- High temperature load: 17A 277VAC at 105°C (Long endurance type)
- 1 Form C and 1 Form A configurations available
- Double pins and Single pin terminal available, effectively reduce terminal temperature rise
- Product in accordance to EN 60335-1 available
- UL insulation system: Class F available
- Environmental friendly product (RoHS compliant)

CONTACT DATA

Contact arrangement	1A	1C
Contact resistance	100mΩ max. (at 1A 24VDC)	
Contact material	AgSnO ₂ , AgNi	
Contact rating (Res. load)	20A 125VAC 17A 277VAC(Q type) 7A 400VAC	NO:17A 277VAC(Q type) NC:10A 277VAC
Max. switching voltage	400VAC	400VAC (NO)
Max. switching current	20A	17A
Max. switching power	4700VA	4700VA
Mechanical endurance	1 x 10 ⁷ OPS	
Electrical endurance	1H type: 5 x 10 ⁴ OPS (16A 277VAC, Resistive load, AgNi, at 85°C, 1s on 9s off) 1HT type: 1 x 10 ⁵ OPS (12A 277VAC, Resistive load, AgSO ₂ , at 105°C, 1s on 9s off)	

Notes: For plastic sealed type, the venting-hole should be opened in electrical endurance test.

CHARACTERISTICS

Insulation resistance	1000MΩ (at 500VDC)	
Dielectric strength	Between coil & contacts	2500VAC 1min
	Between open contacts	1000VAC 1min
Operate time (at nomi. volt.)	10ms max.	
Release time (at nomi. volt.)	5ms max.	
Shock resistance	Functional	98m/s ²
	Destructive	980m/s ²
Vibration resistance	10Hz to 55Hz 1.5mm DA	
Humidity	5% to 85% RH	
Ambient temperature	-40°C to 105°C	
Termination	PCB	
Unit weight	Approx. 14g	
Construction	Plastic sealed, Flux proofed	

- Notes:** 1) The data shown above are initial values.
2) Please find coil temperature curve in the characteristic curves below.
3) UL insulation system: Class F, Class B.

COIL

Coil power	Approx. 360mW
------------	---------------

COIL DATA

at 23°C

Nominal Voltage VDC	Pick-up Voltage VDC max.	Drop-out Voltage VDC min.	Max. Voltage VDC*	Coil Resistance Ω
3	2.25	0.3	3.9	25 x (1±10%)
5	3.75	0.5	6.5	70 x (1±10%)
6	4.50	0.6	7.8	100 x (1±10%)
9	6.75	0.9	11.7	225 x (1±10%)
12	9.00	1.2	15.6	400 x (1±10%)
18	13.5	1.8	23.4	900 x (1±10%)
24	18.0	2.4	31.2	1600 x (1±10%)
48	36.0	4.8	62.4	6400 x (1±10%)

Notes: *Maximum voltage refers to the maximum voltage which relay coil could endure in a short period of time.

SAFETY APPROVAL RATINGS

UL/ CUL	NO, Standard Type	AgNi	20A 125VAC Resistive at 40°C
		AgSnO ₂	17A 125VAC Resistive at 85°C 16A 277VAC Resistive at 85°C 10A 277VAC Resistive at 105°C
NO, Q Type	AgNi	AgSnO ₂	12A 277VAC General Use at 105°C 1/2HP 125VAC at 40°C 1HP 250VAC at 40°C TV-8 125VAC at 40°C
		AgNi	17A 277VAC Resistive at 105°C 10A 277VAC Resistive at 105°C
NC	AgNi	AgSnO ₂	20A 125VAC Resistive at 40°C 10A 277VAC Resistive at 85°C
		AgNi	7A 277VAC Resistive at 105°C
	1 Form A, Standard Type	AgNi	16A 250VAC Resistive at 85°C 7A 400VAC Resistive at 105°C
1 Form A, Q Type	AgNi	AgSnO ₂	8A 250VAC COSφ=0.4 at 85°C 10(4)A 250VAC Resistive at 105°C (EN60730-1)
		AgNi	17A 250VAC at 23°C 2h/ at 105°C 2h 10A 250VAC at 23°C 2h/ at 105°C 2h
1 Form C	AgNi	NO/NC:10A/7A 250VAC at 105°C	

- Notes:** 1) All values unspecified are at room temperature.
2) Only typical loads are listed above. Other load specifications can be available upon request.



HONGFA RELAY

ISO9001, ISO/TS16949, ISO14001, OHSAS18001, IECQ QC 080000 CERTIFIED

ORDERING INFORMATION

Type		HF152FD / 12 -1Z P S T G F Q (XXX)	
Coil voltage	3, 5, 6, 9, 12, 18, 24, 48VDC		
Contact arrangement	1H: 1 Form A	1Z: 1 Form C	
Pin version	P: Double pins	Nil: Single pin	
Construction ¹⁾	S: Plastic sealed	Nil: Flux proofed	
Contact material	T: AgSnO ₂	Nil: AgNi	
Contact plating	G: Gold plated	Nil: No gold plated	
Insulation standard	F: Class F	Nil: Class B	
Contact endurance	Q: Long endurance type (Only for AgNi type)	Nil: Standard type	
Special code ⁴⁾	XXX: Customer special requirement	Nil: Standard	

- Notes:** 1) Under the ambience with dangerous gas like H₂S, SO₂ or NO₂, plastic sealed type is recommended; Please test the relay in real applications. If the ambience allows, flux proofed type is preferentially recommended.
 2) Contact is recommended for suitable condition and specifications if water cleaning or surface process is involved in assembling relays on PCB.
 3) If plastic sealed type is selected for cleaning purpose, the vent-hole cover should be excised after cleaning.
 4) The customer special requirement express as special code after evaluating by Hongfa.

OUTLINE DIMENSIONS, WIRING DIAGRAM AND PC BOARD LAYOUT

Unit: mm

Single pin version

Outline Dimensions

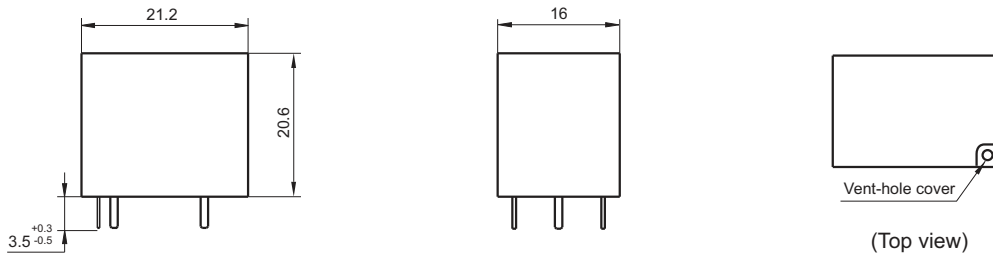

Wiring Diagram

(Bottom view)



PCB Layout

(Bottom view)

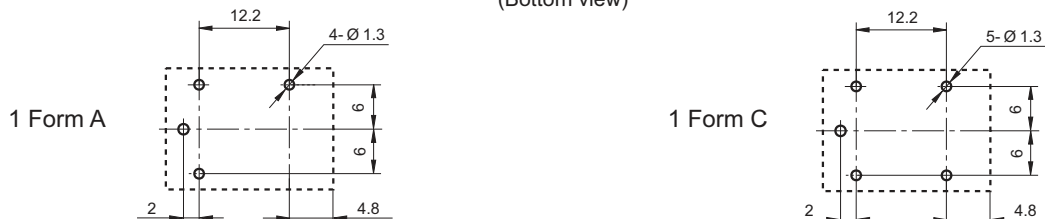

OUTLINE DIMENSIONS, WIRING DIAGRAM AND PC BOARD LAYOUT

Unit: mm

Double pin version

Outline Dimensions

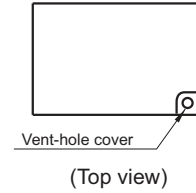
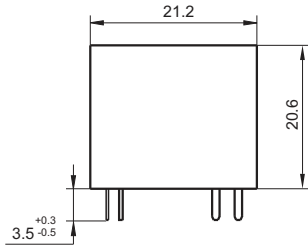

Wiring Diagram (Bottom view)

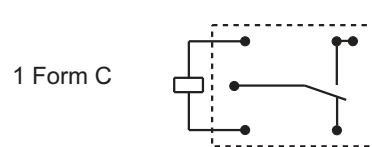
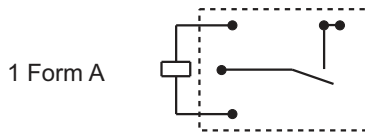

PCB Layout (Bottom view)

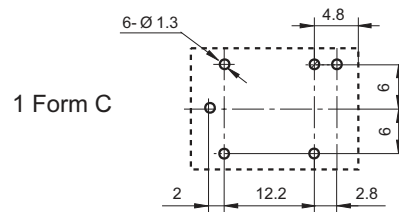
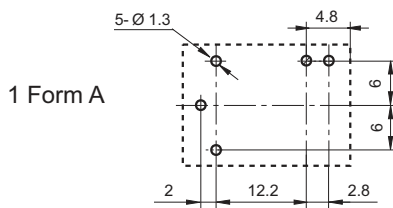

Remark: 1) In case of no tolerance shown in outline dimension: outline dimension ≤ 1 mm, tolerance should be ± 0.2 mm; outline dimension > 1 mm and ≤ 5 mm, tolerance should be ± 0.3 mm; outline dimension > 5 mm, tolerance should be ± 0.4 mm.
2) The tolerance without indicating for PCB layout is always ± 0.1 mm.

CHARACTERISTIC CURVES

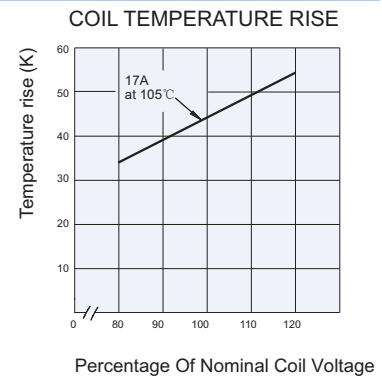
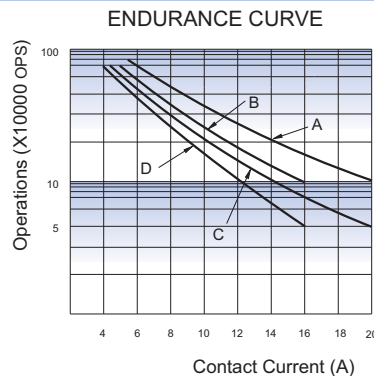
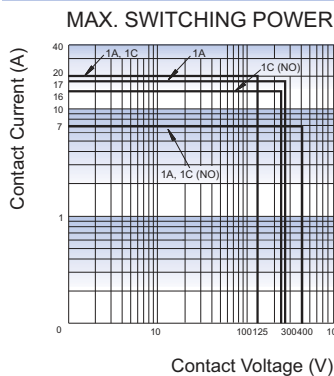

Notes:

- Curve A:1H type, Curve B:1H type, Curve C:1Z type, Curve D:1Z type
- Test conditions:
Curve A: 20A 125VAC, Resistive load, Room temp., 1s on 9s off
Curve B: 16A 250VAC, Resistive load, at 85°C, 1s on 9s off
Curve C: NO, 20A 125VAC, Resistive load, Room temp., 1s on 9s off
Curve D: NO, 16A 250VAC, Resistive load, at 85°C, 1s on 9s off

Disclaimer

The specification is for reference only. See to "Terminology and Guidelines" for more information. Specifications subject to change without notice. We could not evaluate all the performance and all the parameters for every possible application. Thus the user should be in a right position to choose the suitable product for their own application. If there is any query, please contact Hongfa for the technical service. However, it is the user's responsibility to determine which product should be used only.

© Xiamen Hongfa Electroacoustic Co., Ltd. All rights of Hongfa are reserved.

HF7520

SUBMINIATURE POWER RELAY



File No.: E133481



File No.: R50351269



File No.: CQC09002034524

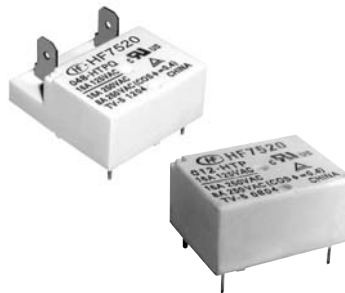

Features

- Low height, flat construction
- High rating: 16A
- High sensitive: 200mW
- PCB & QC layouts available
- Plastic sealed and flux proofed types (with vent-hole cover) available
- UL insulation system: Class F available
- Environmental friendly product (RoHS compliant)
- Outline Dimensions: PCB: (22.0 x 16.0 x 10.5) mm
QC: (22.5 x 25.2 x 10.8) mm

CONTACT DATA

Arrangement	1C	1A
Contact resistance	100mΩ max.(at 1A 6VDC)	
Contact material	See ordering info.	
Contact rating (Res. load)	NO: 10A 125/250VAC	Standard type: TV-5 10A 30VDC 10A 125/250VAC
	NC: 6A 125/250VAC	High capacity type: TV-5 10A 30VDC 16A 125/250VAC 8A 250VAC(cosφ=0.4)
Max.switching voltage	250VAC	250VAC/30VDC
Max.switching current	NO:10A NC: 6A	16A
Max.switching power	NO: 2500VA NC: 1500VA	4000VA/300W
Mechanical endurance	1 x 10 ⁷ OPS	
Electrical endurance	HP type: 5 x 10 ⁴ ops (16A 125VAC, Resistive load, Room temp., 1s on 9s off)	
	H type: 5 x 10 ⁴ ops (10A 250VAC, Resistive load, Room temp., 1s on 9s off)	
	Z type: 5 x 10 ⁴ ops (NO, 10A 250VAC, Resistive load, Room temp., 1s on 9s off)	
	Z type: 5 x 10 ⁴ ops (NC, 6A 250VAC, Resistive load, Room temp., 1s on 9s off)	

Notes: For plastic sealed type, the venting-hole should be opened in electrical endurance test.

COIL

Coil power	1 Form A: Approx. 200mW; 1 Form C: Approx. 400mW
------------	---

CHARACTERISTICS

Insulation resistance	1000MΩ (at 500VDC)	
Dielectric strength	Between coil & contacts	2500VAC 1 min
	Between open contacts	1000VAC 1 min
Operate time (at nomi.volt)	15ms max.	
Release time (at nomi.volt)	5ms max.	
Shock resistance	Functional	98m/s ²
	Destructive	980m/s ²
Vibration resistance	10Hz to 55Hz 1.5mm DA	
Humidity	5% to 85% RH	
Ambient temperature	-40°C to 105°C	
Termination	1C: PCB	
	1A: PCB & QC	
Unit weight	PCB: Approx.10g QC: Approx.12g	
Construction	Plastic sealed, Flux proofed	

Notes: 1) The data shown above are initial values.
2) Please find coil temperature curve in the characteristic curves below.

SAFETY APPROVAL RATINGS

UL/CUL	1 Form A	TV-5 125VAC 16A 125VAC at 85°C 10A 250VAC at 85°C 10A 30VDC at 85°C 0.3A 110VDC at 85°C 13A 125VAC at 105°C 10A 250VAC at 105°C
	1 Form C	NO: 10A 250VAC NC: 6A 250VAC
TÜV	1 Form A	16A 250VAC 10A 30VDC 8A 250VAC (COSφ=0.4)

Notes: 1) All values unspecified are at room temperature.
2) Only typical loads are listed above. Other load specifications can be available upon request.



HONGFA RELAY

ISO9001, ISO/TS16949, ISO14001, OHSAS18001, IECQ QC 080000 CERTIFIED

COIL DATA

at 23°C

1 Form C type

Nominal Voltage VDC	Pick-up Voltage VDC max.	Drop-out Voltage VDC min.	Max. Voltage VDC*	Coil Resistance Ω
5	4.0	0.5	6.5	62.5 x (1±10%)
6	4.8	0.6	7.8	90 x (1±10%)
9	7.2	0.9	11.7	202.5 x (1±10%)
12	9.6	1.2	15.6	360 x (1±10%)
18	14.4	1.8	23.4	810 x (1±10%)
24	19.2	2.4	31.2	1440 x (1±10%)
48	38.4	4.8	62.4	5760 x (1±10%)

1 Form A type

Nominal Voltage VDC	Pick-up Voltage VDC max.	Drop-out Voltage VDC min.	Max. Voltage VDC*	Coil Resistance Ω
5	4.0	0.5	6.5	125 x (1±10%)
6	4.8	0.6	7.8	180 x (1±10%)
9	7.2	0.9	11.7	405 x (1±10%)
12	9.6	1.2	15.6	720 x (1±10%)
18	14.4	1.8	23.4	1620 x (1±10%)
24	19.2	2.4	31.2	2880 x (1±10%)
48	38.4	4.8	62.4	11520 x (1±10%)

Notes: *Maximum voltage refers to the maximum voltage which relay coil could endure in a short period of time.

ORDERING INFORMATION

Type	HF7520 / 012 -H S T P Q (XXX)
Coil voltage	5, 6, 9, 12, 18, 24, 48VDC
Contact arrangement	H: 1 Form A Z: 1 Form C
Construction ¹⁾	S: Plastic sealed Nil: Flux proofed
Contact material	T: AgSnO ₂ Nil: AgCdO (Only for 1 Form A) AgNi (Only for 1 Form C)
Contact capacity	P: High Capacity type (Only for 1 Form A) Nil: Standard type
Terminal type	Q: QC (Only for 1 Form A and high capacity type) Nil: PCB
Special code ⁴⁾	XXX: Customer special requirement Nil: Standard

Notes: 1) We recommend flux proofed types for a clean environment (free from contaminations like H₂S, SO₂, NO₂, dust, etc.).

We suggest to choose plastic sealed types and validate it in real application for an unclean environment (with contaminations like H₂S, SO₂, NO₂, dust, etc.).

2) Contact is recommended for suitable condition and specifications if water cleaning or surface process is involved in assembling relays on PCB.

3) When the ambient temperature reaches 105°C degree or more, please select flux proofed and high capacity type. Besides, please indicate the exact ambient temperature when ordering.

4) The customer special requirement express as special code after evaluating by Hongfa.

OUTLINE DIMENSIONS , WIRING DIAGRAM AND PC BOARD LAYOUT

Unit: mm

1 Form A (PCB)

Outline Dimensions

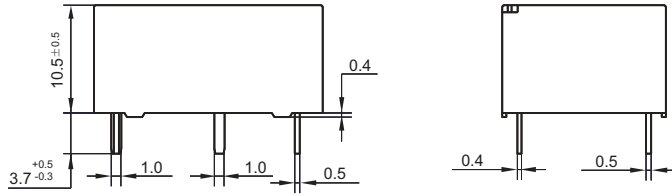

Wiring Diagram (Bottom View)

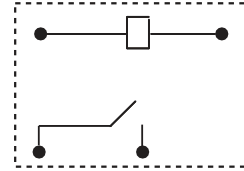

PCB Layout (Bottom view)

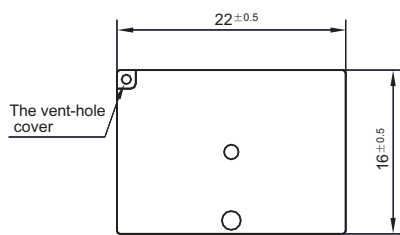
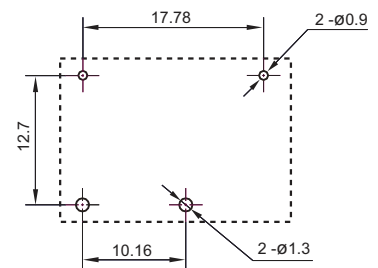

(Top view)

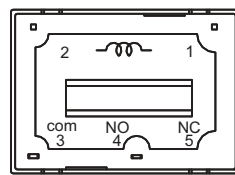

(Bottom View)

1 Form A (QC)

Outline Dimensions

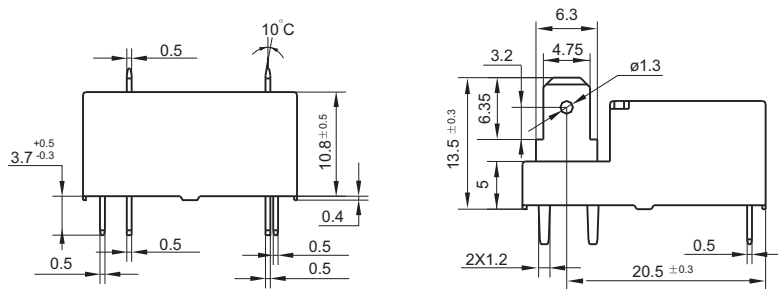

Wiring Diagram

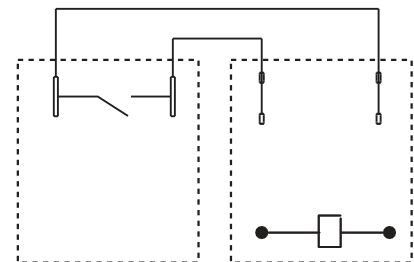

(Top View)

(Bottom View)

PCB Layout (Bottom view)

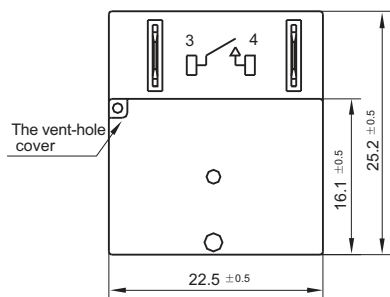
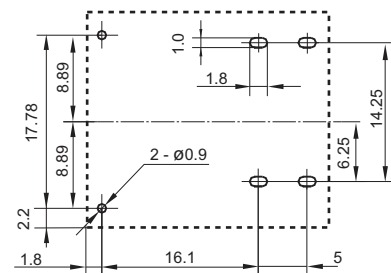

(Top view)

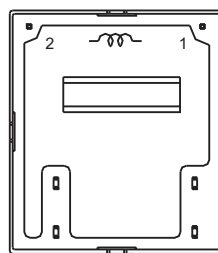

(Bottom View)

OUTLINE DIMENSIONS , WIRING DIAGRAM AND PC BOARD LAYOUT

Unit: mm

1 Form C (PCB)

Outline Dimensions

Wiring Diagram
(Bottom View)

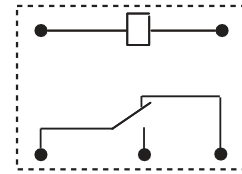
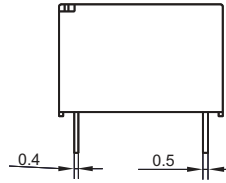
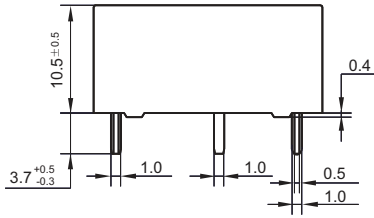

PCB Layout
(Bottom view)

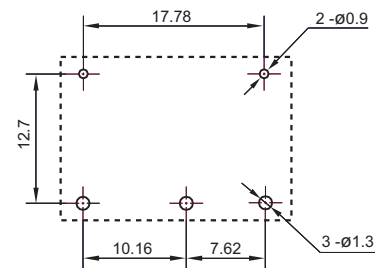
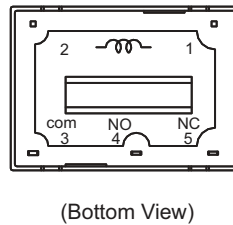
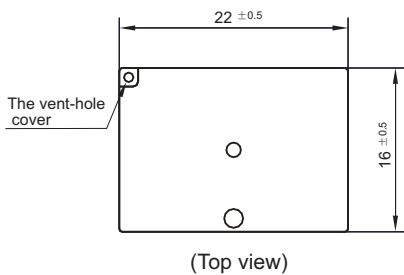

Remark: 1) In case of no tolerance shown in outline dimension: outline dimension $\leq 1\text{mm}$, tolerance should be $\pm 0.2\text{mm}$; outline dimension $> 1\text{mm}$ and $\leq 5\text{mm}$, tolerance should be $\pm 0.3\text{mm}$; outline dimension $> 5\text{mm}$, tolerance should be $\pm 0.4\text{mm}$.
2) The tolerance without indicating for PCB layout is always $\pm 0.1\text{mm}$.

CHARACTERISTIC CURVES

MAXIMUM SWITCHING POWER

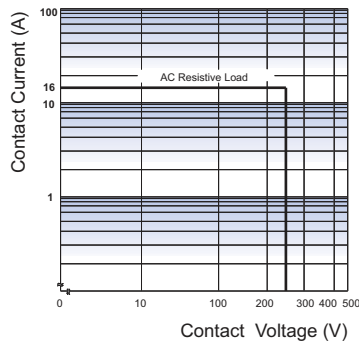

ENDURANCE CURVE

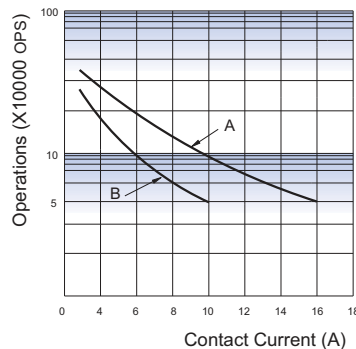

COIL TEMPERATURE RISE

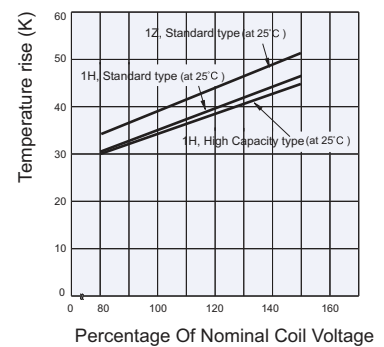

Notes:

- (1) Curve A: HP type
Curve B: H type
- (2) Test conditions:
Curve A: 16A 125VAC, Resistive load,
Room temp., 1s on 9s off
Curve B: 10A 250VAC, Resistive load,
Room temp., 1s on 9s off

Disclaimer

The specification is for reference only. See to "Terminology and Guidelines" for more information. Specifications subject to change without notice. We could not evaluate all the performance and all the parameters for every possible application. Thus the user should be in a right position to choose the suitable product for their own application. If there is any query, please contact Hongfa for the technical service. However, it is the user's responsibility to determine which product should be used only.

© Xiamen Hongfa Electroacoustic Co., Ltd. All rights of Hongfa are reserved.

HF163F-L SUBMINIATURE INTERMEDIATE POWER LATCHING RELAY



File No.: E134517



File No.: 40039460



Features

- Latching relay
- High sensitive
- Breakdown voltage (between contact and coil): 5,000 V
- High switching capacity: 8A 250VAC
- Surge breakdown voltage (between contact and coil): 12,000 V
- Reflow soldering available
- 1 Form A configuration
- Environmental friendly product (RoHS compliant)
- Outline Dimensions: (24.0 x 10.0 x 18.8) mm

CONTACT DATA

Contact arrangement	1A
Contact resistance	100mΩ max. (at 1A 6VDC)
Contact material	AgSnO ₂
Contact rating (Res. load)	8A 250VAC 5A 30VDC
Max. switching voltage	250VAC / 30VDC
Max. switching current	10A
Max. switching power	2500VA/150W
Mechanical endurance	1 x 10 ⁶ OPS
Electrical endurance	5 x 10 ⁴ OPS(8A 250VAC, Resistive load, at 85°C, 1s on 9s off)

CHARACTERISTICS

Insulation resistance		1000MΩ (at 500VDC)
Dielectric strength	Between coil & contacts	5000VAC 1min
	Between open contacts	1000VAC 1min
Set time		15ms max.
Reset time		15ms max.
Shock resistance	Functional	98m/s ²
	Destructive	980m/s ²
Vibration resistance		10Hz to 55Hz 2.0mm DA
Humidity		5% to 85% RH
Ambient temperature		-40°C to 85°C
Termination		PCB
Unit weight		Approx. 8g
Construction		Flux proofed

Notes: The data shown above are initial values.

COIL

Coil power	1 coil latching	Approx. 200mW
	2 coils latching	Approx. 400mW

COIL DATA

at 23°C

1 coil latching (200mW)

Nominal Voltage VDC	Set Voltage VDC max.	Reset Voltage VDC max.	Coil Resistance x (1±10%) Ω
3	2.4	2.4	45
5	4.0	4.0	125
6	4.8	4.8	180
9	7.2	7.2	405
12	9.6	9.6	720
24	19.2	19.2	2880

2 coils latching (400mW)

Nominal Voltage VDC	Set Voltage VDC max.	Reset Voltage VDC max.	Coil Resistance x (1±10%) Ω
3	2.4	2.4	22.5
5	4.0	4.0	62.5
6	4.8	4.8	90
9	7.2	7.2	202.5
12	9.6	9.6	360
24	19.2	19.2	1440

SAFETY APPROVAL RATINGS

UL/CUL	8A 250VAC at 85°C 5A 30VDC at 85°C 10A 250VAC at 40°C TV-3 125VAC at 40°C 800W 277VAC Tungsten at 40°C 4A 277VAC Standard Ballast at 40°C
	8A 250VAC at 85°C 5A 30VDC at 85°C

- Notes: 1) All values unspecified are at room temperature.
2) Only typical loads are listed above. Other load specifications can be available upon request.



HONGFA RELAY

ISO9001, ISO/TS16949, ISO14001, OHSAS18001, IECQ QC 080000 CERTIFIED

ORDERING INFORMATION

Type	HF163F-L/	12	-H	L2	T	(XXX)
Coil voltage	3, 5, 6, 9, 12, 24VDC					
Contact form	H: 1 Form A					
Sort	L1: 1 coil latching		L2: 2 coils latching			
Contact material	T: AgSnO ₂					
Special code ⁴⁾	XXX: Customer special requirement		Nil: Standard			

- Notes:**
- 1) We recommend flux proofed types for a clean environment (free from contaminations like H₂S, SO₂, NO₂, dust, etc.).
 - 2) Contact is recommended for suitable condition and specifications if water cleaning or surface process is involved in assembling relays on PCB.
 - 3) For gold plated type, the min. switching current and min. switching voltage is 10mA 5VDC.
 - 4) The customer special requirement express as special code after evaluating by Hongfa. e.g.(335) stands for product in accordance to IEC 60335-1 (GWT); e.g.(470) stands for product which is suitable for reflow soldering.

OUTLINE DIMENSIONS, WIRING DIAGRAM AND PC BOARD LAYOUT

Unit: mm

Outline Dimensions

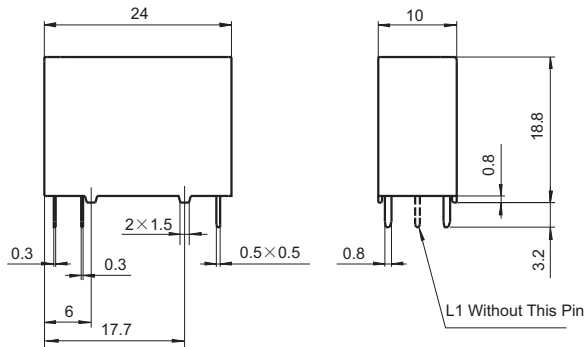

PCB Layout
(Bottom view)

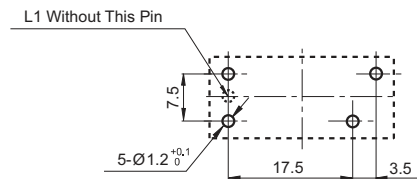

- Remark:
- 1) In case of no tolerance shown in outline dimension: outline dimension $\leq 1\text{mm}$, tolerance should be $\pm 0.2\text{mm}$; outline dimension $> 1\text{mm}$ and $\leq 5\text{mm}$, tolerance should be $\pm 0.3\text{mm}$; outline dimension $> 5\text{mm}$, tolerance should be $\pm 0.4\text{mm}$.
 - 2) The tolerance without indicating for PCB layout is always $\pm 0.1\text{mm}$.
 - 3) The width of the gridding is 2.54mm.

Wiring Diagram
(Bottom view)

Reset Status



RECOMMENDED SOLDERING CONDITIONS

Temperature/Time profile of Reflow Soldering see below:

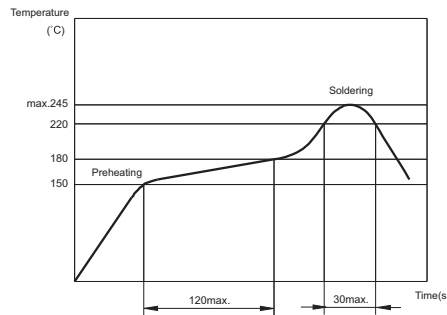

- Notes:** 1) Temperature profile shows Printed Circuit Board surface temperature on the relay terminal portion.
2) Please check the actual soldering condition to use other method except above mentioned temperature profiles.

Notice

- Relay is on the "reset" or "set" status when being released from stock, with the consideration of shock risen from transit and relay mounting, relay would be changed to "set" or "reset" status, therefore, when application (connecting the power supply), please reset the relay to "set" or "reset" status on request.
- In order to maintain "set" or "reset" status, energized voltage to coil should reach the rated voltage, impulse width should be 5 times more than "set" or "reset" time. Do not energize voltage to "set" coil and "reset" coil simultaneously. And also long energized time (more than 1 min) should be avoided.
- Keep the product away from strong magnetic field during transportation, storage and application, to avoid change of set/reset voltage.

Disclaimer

The specification is for reference only. See to "Terminology and Guidelines" for more information. Specifications subject to change without notice. We could not evaluate all the performance and all the parameters for every possible application. Thus the user should be in a right position to choose the suitable product for their own application. If there is any query, please contact Hongfa for the technical service. However, it is the user's responsibility to determine which product should be used only.

HFE7

SUBMINIATURE INTERMEDIATE POWER RELAY



File No.:E134517



File No.:40027342

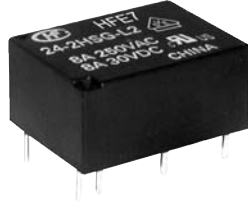

Features

- High switching capacity
1A, 1B: 10A 250VAC/30VDC;
2A, 2B, 1A + 1B: 8A 250VAC/30VDC
- High sensitive
- 4kV dielectric strength (between coil & contacts)
- Single side stable and latching types available
- 1 Form A, 1 Form B, 2 Form A, 2 Form B and 1A + 1B contact arrangement
- Environmental friendly product (RoHS compliant)
- Outline Dimensions: (20.0 x 15.0 x 10.2) mm

CONTACT DATA

Contact arrangement	1A, 1B	2A, 2B, 1A + 1B
Contact resistance	AgNi +Au plated: 30mΩ max.(at 1A 6VDC) AgNi: 50mΩ max.(at 1A 6VDC) AgSnO ₂ +Au plated: 60mΩ max.(at 1A 6VDC) AgSnO ₂ : 80mΩ max.(at 1A 6VDC)	
Contact material	AgSnO ₂ , AgNi	
Contact rating (Res. load)	10A 250VAC/30VDC	8A 250VAC/30VDC
Max. switching Voltage	277VAC	277VAC
Max. switching current	10A	8A
Max. switching power	2500VA	2000VA
Mechanical endurance	1 x 10 ⁷ OPS	
Electrical endurance	1A, 1B type: 1 x 10 ⁵ OPS (10A 250VAC, Resistive load., at 70°C, 1.5s on 1.5s off) 1A + 1B, 2A, 2B type: 3 x 10 ⁴ OPS (8A 250VAC, Resistive load., at 70°C, 1.5s on 1.5s off)	

CHARACTERISTICS

Insulation resistance	1000MΩ (at 500VDC)	
Dielectric Strength	Between coil & contacts	4000VAC 1min
	Between open contacts	1000VAC 1min
Operate time (at nomi. volt.)	10ms max.	
Release (Reset) time (at nomi. volt.)	10ms max.	
Max. operate frequency (under rated load)	20 cycles /min	
Temperature rise (at nomi. volt.)	50 K max.	
Vibration resistance	10Hz to 55Hz 1.5mm DA	
Shock resistance	98m/s ²	
Humidity	5% to 85% RH	
Ambient temperature	-40 °C to 70 °C	
Termination	PCB	
Unit weight	Approx. 6g	
Construction	Plastic sealed, Flux proofed	

Notes: The data shown above are initial values.

COIL

Type		Coil power	
		Sensitive	High sensitive
Single side stable	1A,1A+1B	Approx. 420mW	Approx. 200mW
	2A		Approx. 280mW
Single coils latching		Approx. 300mW	Approx. 200mW
Double coils latching		Approx. 420mW	Approx. 280mW

COIL DATA

at 23°C

Single side stable

Nominal Voltage VDC	Pick-up Voltage VDC max.	Drop-out Voltage VDC min.	Coil Resistance x (±10%)Ω		
			200mW	280mW	420mW
3	2.1	0.3	45	32.1	21.4
5	3.5	0.5	125	89.3	59.5
6	4.2	0.6	180	129	85.7
9	6.3	0.9	405	289	192.9
12	8.4	1.2	720	514	342.9
24	16.8	2.4	2880	2056	1371.4

Single coil latching

Nominal Voltage VDC	Set /Reset Voltage VDC max.	Pulse Duration ms min.	Coil Resistance x (±10%)Ω	
			300mW	200mW
3	2.1	50	30	45
5	3.5	50	83.3	125
6	4.2	50	120	180
9	6.3	50	270	405
12	8.4	50	480	720
24	16.8	50	1920	2880



HONGFA RELAY

ISO9001, ISO/TS16949, ISO14001, OHSAS18001, IECQ QC 080000 CERTIFIED

COIL DATA

at 23°C

Double coils latching

Nominal Voltage VDC	Set / Reset Voltage VDC max.	Pulse Duration ms min.	Coil Resistance x (1±10%) Ω	
			420mW	280mW
3	2.1	50	21.4+21.4	32.1+32.1
5	3.5	50	59.5+59.5	89.3+89.3
6	4.2	50	85.7+85.7	129+129
9	6.3	50	192.9+192.9	289+289
12	8.4	50	342.9+342.9	514+514
24	16.8	50	1371.4+1371.4	2056+2056

SAFETY APPROVAL RATINGS

UL/CUL	1 Form A	AgNi	10A 250VAC 8A 30VDC 1/4HP 125VAC 1/3HP 250VAC
		AgSnO ₂	10A 30VDC B300, R300 10A 250VAC 1/4 HP 125VAC 1/3 HP 250VAC
	2 Form A	AgSnO ₂ , AgNi	8A 250VAC/30VDC 1/4HP 125VAC 1/3HP 250VAC
		AgSnO ₂	600W 125VAC B300, R300
	1 Form A+1 Form B	AgSnO ₂ , AgNi	8A 250VAC/30VDC 1/4HP 125VAC 1/3HP 250VAC
		AgSnO ₂	B300, R300
VDE (No UL approval on Single side stable version)	1 Form A	AgNi	10A 250VAC (cosφ=1) 5A 250VAC (cosφ=0.4)
	2 Form A	AgNi	8A 250VAC (cosφ=1) 3.5A 250VAC (cosφ=0.4)
	1 Form A+1 Form B	AgNi	8A 250VAC (cosφ=1) 3.5A 250VAC (cosφ=0.4)

Notes: 1) All values unspecified are at room temperature.

2) Only typical loads are listed above. Other load specifications can be available upon request.

ORDERING INFORMATION

Type	HFE7 / 12 -1H S T G -L2 -R (412)(XXX)	
Coil voltage	3, 5, 6, 9, 12, 24VDC	
Contact form	1 ¹⁾ H: 1 Form A 1 ¹⁾ D: 1 Form B 2 ¹⁾ H: 2 Form A 2 ¹⁾ D: 2 Form B 1 ¹⁾ HD: 1A + 1B	
Construction	2 ²⁾ S: Plastic sealed Nil: Flux proofed	
Contact material	3 ³⁾ T: AgSnO ₂ Nil: AgNi	
Contact plating	G: Gold plated Nil: No gold plated	
Sort	L1: 1 coil latching L2: 2 coils latching Nil: Single side stable	
Polarity	R: Negative polarity Nil: Positive polarity	
Customer special code (Coil power)	4 ⁴⁾ (412): Sensitive Nil: High sensitive	
Special code	5 ⁵⁾ XXX: Customer special requirement Nil: Standard	

Notes: 1) 1H, 2H means that relay is on the "reset" status when delivery; 1D, 2D means that relay is on the "set" status when delivery. There are no UL approval on 1D, 2D version.

2) Under the ambience with dangerous gas like H₂S, SO₂ or NO₂, plastic sealed type is recommended; Please test the relay in real applications. If the ambience allows, flux proofed type is preferentially recommended. Contact is recommended for suitable condition and specifications if water cleaning or surface process is involved in assembling relays on PCB.

3) For the application with inrush current conditions, such as lamp load, motor load, capacitance load, coil load, etc., we suggest use the flux proof and no golden plated AgSnO₂ contact version.

4) We recommend to choose the sensitive version (same part number, but with special suffix (412)) if the higher coil activation is allowable; Please choose the sensitive version (same part number, but with special suffix (412)) if the relay to be used in the extreme environment or welded by wave soldering; Please check with HF's engineer before designing the relay to your application if there are some requirements' outside the specification we provided.

5) The customer special requirement express as special code after evaluating by Hongfa. e.g. (359) stands for Lamp load.

Outline Dimensions

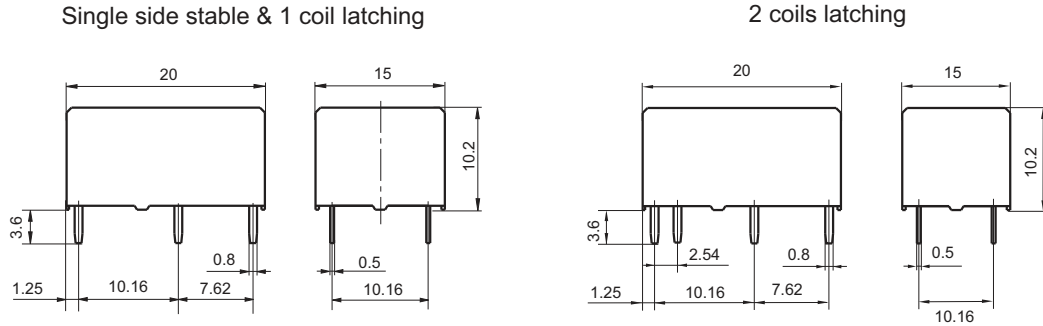

PCB Layout (Bottom view)

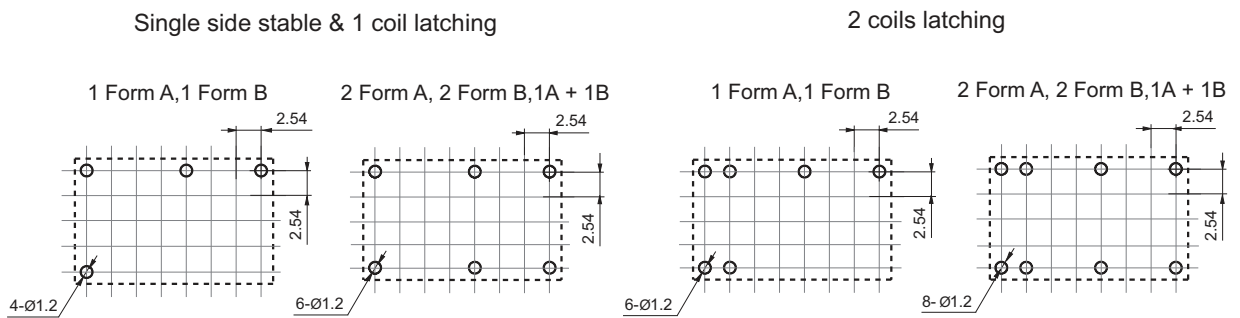

- Remark: 1) In case of no tolerance shown in outline dimension: outline dimension $\leq 1\text{mm}$, tolerance should be $\pm 0.2\text{mm}$; outline dimension $> 1\text{mm}$ and $\leq 5\text{mm}$, tolerance should be $\pm 0.3\text{mm}$; outline dimension $> 5\text{mm}$, tolerance should be $\pm 0.4\text{mm}$.
 2) The tolerance without indicating for PCB layout is always $\pm 0.1\text{mm}$.
 3) The width of the gridding is 2.54mm.

Wiring Diagram (Bottom view)

Single side stable (Standard polarity)

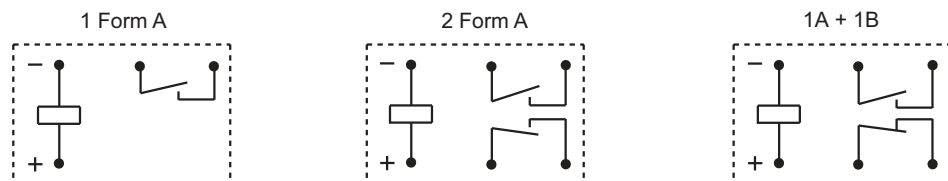

Wiring Diagram (Bottom view)

1 coil latching (Standard polarity)

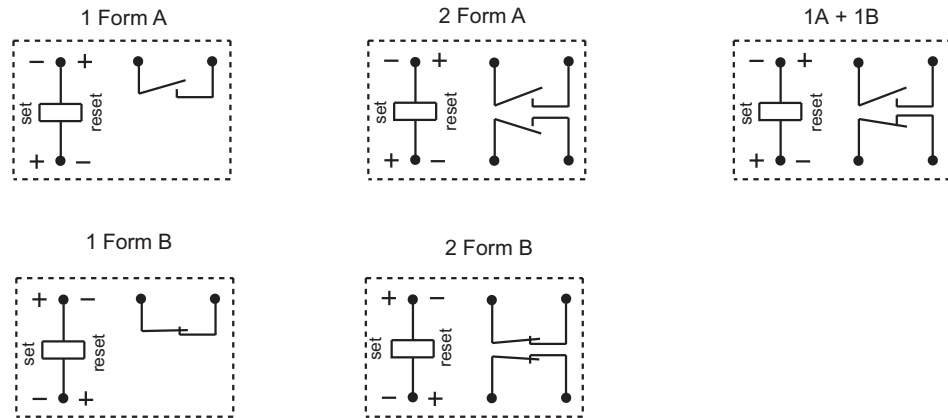

2 coils latching (Standard polarity)

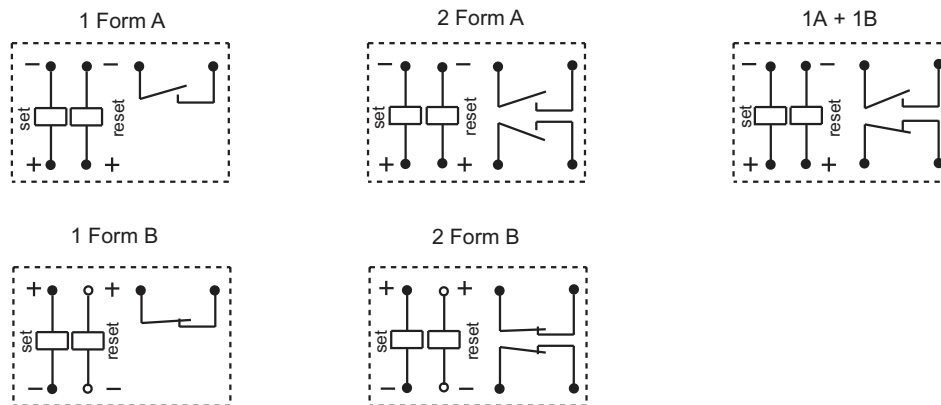

Remark: The coil polarity of Reverse polarity and Standard polarity is opposite.

Notice

1. Relay is on the "reset" or "set" status when being released from stock, with the consideration of shock risen from transit and relay mounting, relay would be changed to "set" or "reset" status, therefore, when application (connecting the power supply), please reset the relay to "set" or "reset" status on request.
2. In order to maintain "set" or "reset" status, energized voltage to coil should reach the rated voltage, impulse width should be 5 times more than "set" or "reset" time. Do not energize voltage to "set" coil and "reset" coil simultaneously. And also long energized time (more than 1 min) should be avoided.
3. As the relay component part's will shrink and deformed due to the high temperature impact, our products are forbidden to be used at the temperature outside our suggested working temperature range (-40°C to 70°C) for long time ; If the wave soldering will be used, the operating parameters we will suggest are: Up limit of the pre-heating time: 120s; Up limit of the pre-heating temperature:120°C; Soldering temperature: 260°C±5°C; Soldering time (10±3) s; Besides our suggested parameters, please try to shorten the pre-heating time and the soldering time and try to lower the temperature for pre-heating and the soldering as you can; the manual soldering for such relay is more recommended.

Disclaimer

This datasheet is for the customers' reference. All the specifications are subject to change without notice.

We could not evaluate all the performance and all the parameters for every possible application. Thus the user should be in a right position to choose the suitable product for their own application. If there is any query, please contact Hongfa for the technical service. However, it is the user's responsibility to determine which product should be used only.

© Xiamen Hongfa Electroacoustic Co., Ltd. All rights of Hongfa are reserved.

HF118F

MINIATURE HIGH POWER RELAY



File No.: E134517



File No.: 40010480



File No.: CQC09002035071



Features

- 10A switching capability
- 5kV dielectric strength (between coil and contacts)
- Low height: 12.5 mm
- Creepage distance >8mm
- Meeting VDE 0700, 0631 reinforce insulation
- Product in accordance to IEC 60335-1 available
- UL insulation system: Class F
- Sockets available
- Plastic sealed and flux proofed types available
- Environmental friendly product (RoHS compliant)
- Outline Dimensions: (28.5 x 10.1 x 12.5) mm

CONTACT DATA

Contact arrangement	1A, 1B, 1C
Contact material	See ordering info.
Contact resistance	100mΩ max.(at 1A 6VDC)
Contact rating (Res. load)	10A 250VAC/30VDC
Max. switching voltage	440VAC / 125VDC
Max. switching current	10A
Max. switching power	2500VA / 300W
Mechanical endurance	1 x 10 ⁷ OPS
Electrical endurance	1H type: 1 x 10 ⁵ OPS (AgNi, 8A 250VAC, Resistive load, at 85°C, 5s on 5s off)

CHARACTERISTICS

Insulation resistance	1000MΩ (at 500VDC)	
Dielectric strength	Between coil & contacts	5000VAC 1min
	Between open contacts	1000VAC 1min
Surge voltage (between coil & contacts)	10kV (1.2 / 50μs)	
Operate time (at nomi. vot.)	10ms max.	
Release time (at nomi. vot.)	5ms max.	
Temperature rise (at nomi. Volt.)	55K max.	
Shock resistance *	Functional	NC: 49m/s ² NO: 98m/s ²
	Destructive	980m/s ²
Vibration resistance *	NC (no coil voltage)	10Hz to 55Hz 0.8mm DA
	NO	10Hz to 55Hz 1.65mm DA
Ambient temperature	-40°C to 85°C	
Humidity	5% to 85% RH	
Termination	PCB	
Unit weight	Approx. 8g	
Construction	Plastic sealed, Flux proofed	

Notes: 1) The data shown above are initial values.

2) * Index is not in relay length direction.

COIL

Coil power	Approx. 220mW to 290mW
------------	------------------------

COIL DATA

at 23°C

Nominal Voltage VDC	Pick-up Voltage VDC max.	Drop-out Voltage VDC min.	Max. Voltage VDC ¹⁾	Coil Resistance Ω
5	3.50	0.5	7.5	113 x (1±10%)
6	4.20	0.6	9.0	164 x (1±10%)
9	6.30	0.9	13.5	360 x (1±10%)
12	8.40	1.2	18.0	620 x (1±10%)
18	12.60	1.8	27.0	1295 x (1±10%)
24	16.80	2.4	36.0	2350 x (1±15%)
48 ²⁾	33.60	4.8	72.0	8000 x (1±15%)
60 ²⁾	42.00	6.0	90.0	12500 x (1±15%)

Notes: 1) Maximum voltage refers to the maximum voltage which relay coil could endure in a short period of time.

2) For products with rated voltage ≥ 48V, measures should be taken to prevent coil overvoltage in order to protect coil in test and application (eg. Connect diodes in parallel).



HONGFA RELAY

ISO9001, ISO/TS16949, ISO14001, OHSAS18001, IECQ QC 080000 CERTIFIED

SAFETY APPROVAL RATINGS

UL/CUL (AgNi, AgSnO ₂)	version 1,3,5,6	10A 250VAC at 85°C
		10A 30VDC at 85°C
VDE (AgNi, AgNi+Au)	1H (;S) (1;3;5) (-;G)	B300 at 85°C
	1D (;S) (1;3;6) (-;G)	R300 at 85°C
	1Z (-;S) (1;3) (-;G)	1/2HP 240VAC at 85°C
VDE (AgSnO ₂ , AgSnO ₂ +Au)	1H (-;S) (1;3;5), T.(-;G)	AgSnO ₂ : 1/3HP 120VAC at 85°C
	1D (-;S) (1;3;6), T.(-;G)	8A 250VAC at 85°C
	1Z (-;S) (1;3), T.(-;G)	8A 250VAC at 85°C
	1H (-;S) (1;3;5), T.(-;G)	8A 250VAC at 85°C
	1Z (-;S) (1;3), T.(-;G)	AC-15 (Make: 30A 250VAC COS Ø=0.7 at 85°C Break: 3A 250VAC COS Ø=0.4 at 85°C)
		NO: AC-15 (Make: 30A 250VAC COS Ø=0.7 at 85°C Break: 3A 250VAC COS Ø=0.4 at 85°C)

Notes: 1) All values unspecified are at room temperature.

2) Only typical loads are listed above. Other load specifications can be available upon request.

ORDERING INFORMATION

Type	HF118F / 012 -1H S 1 G (XXX)
Coil voltage	5, 6, 9, 12, 18, 24, 48, 60VDC
Contact arrangement	1H: 1 Form A 1D: 1 Form B 1Z: 1 Form C
Construction ¹⁾²⁾	S: Plastic sealed Nil: Flux proofed
Version (See Wiring Diagram below)	1: 3.2mm 1 pole 8A 3: 3.2mm 1 pole 10A, double pinning 5: 5mm 8A, only 1 Form A 6: 5mm 8A, only 1 Form B
Contact material ³⁾	T: AgSnO ₂ G: AgNi+Au plated TG: AgSnO ₂ +Au plated Nil: AgNi
Special code ⁴⁾	XXX: Customer special requirement Nil: Standard

Notes: 1) We recommend flux proofed types for a clean environment (free from contaminations like H₂S, SO₂, NO₂, dust, etc.).

We suggest to choose plastic sealed types and validate it in real application for an unclean environment (with contaminations like H₂S, SO₂, NO₂, dust, etc.).

2) Contact is recommended for suitable condition and specifications if water cleaning or surface process is involved in assembling relays on PCB.

3) For gold plated type, the min. switching current and min. switching voltage is 10mA 5VDC.

4) The customer special requirement express as special code after evaluating by Hongfa. e.g. (335) stands for product in accordance to IEC 60335-1 (GWT); e.g.(253) stands for Reflow soldering version.

OUTLINE DIMENSIONS, WIRING DIAGRAM AND PC BOARD LAYOUT

Unit: mm

Outline Dimensions

3.2mm pinning

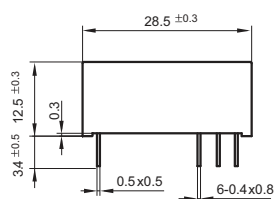

5mm pinning

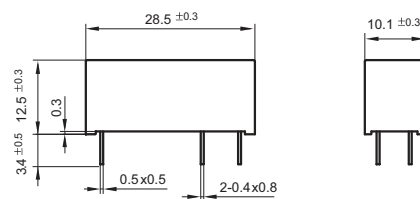

OUTLINE DIMENSIONS, WIRING DIAGRAM AND PC BOARD LAYOUT

Unit: mm

Wiring Diagram (Bottom view)

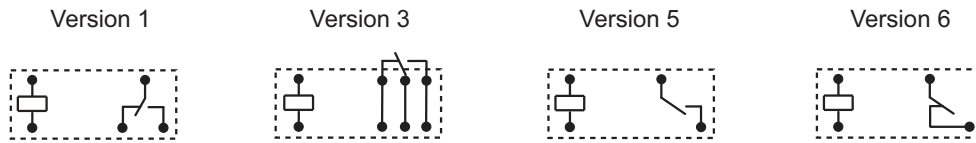

PCB Layout (Bottom view)

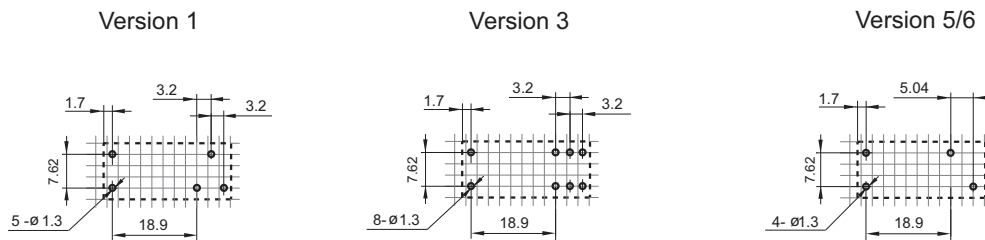

- Remark: 1) In case of no tolerance shown in outline dimension: outline dimension $\leq 1\text{mm}$, tolerance should be $\pm 0.2\text{mm}$; outline dimension $> 1\text{mm}$ and $\leq 5\text{mm}$, tolerance should be $\pm 0.3\text{mm}$; outline dimension $> 5\text{mm}$, tolerance should be $\pm 0.4\text{mm}$.
 2) The tolerance without indicating for PCB layout is always $\pm 0.1\text{mm}$.
 3) The width of the gridding is 2.54mm.

CHARACTERISTIC CURVES

MAXIMUM SWITCHING POWER

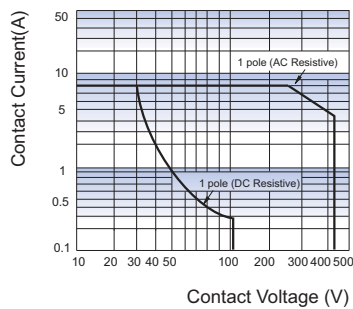

ENDURANCE CURVE

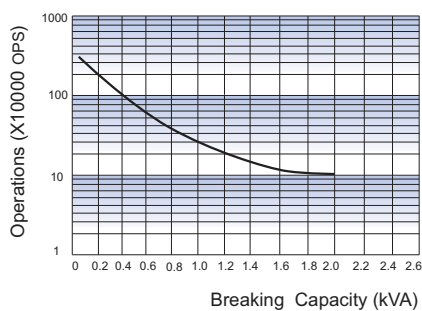

REFLOW WELDING TEMPERATURE
(Reflow soldering version)

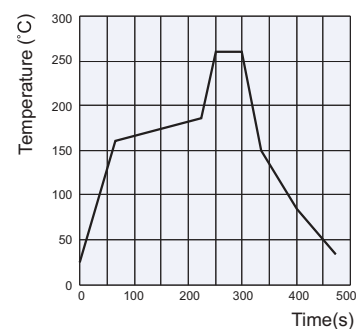

Notes:

- 1) Curve: 1Z1 type
- 2) Test conditions:
 NO, Resistive load, 250VAC
 Flux proofed, Room temp., 1s on 9s off.

Disclaimer

The specification is for reference only. See to "Terminology and Guidelines" for more information. Specifications subject to change without notice. We could not evaluate all the performance and all the parameters for every possible application. Thus the user should be in a right position to choose the suitable product for their own application. If there is any query, please contact Hongfa for the technical service. However, it is the user's responsibility to determine which product should be used only.

HF115F

MINIATURE HIGH POWER RELAY



File No.:E134517



File No.:116934



File No.:CQC08002028130



Features

- Low height: 15.7 mm
- 16A switching capability
- 5kV dielectric strength (between coil and contacts)
- Creepage distance: 10mm
- Meeting VDE 0700, 0631 reinforce insulation
- Product in accordance to IEC 60335-1 available
- Sockets available
- Plastic sealed and flux proofed types available
- UL insulation system: Class F available
- Environmental friendly product (RoHS compliant)
- Outline Dimensions: (29.0 x 12.7 x 15.7) mm

CONTACT DATA

Contact arrangement	1A, 1B, 1C	2A, 2B, 2C
Contact resistance	100mΩ max.(at 1A 6VDC)	
Contact material	See ordering info.	
Contact rating (Res. load)	12A/16A 250VAC	8A 250VAC
Max. switching voltage	440VAC / 300VDC	
Max. switching current	12A / 16A	8A
Max. switching power	3000VA / 4000VA	2000VA
Mechanical endurance	1 x 10 ⁷ OPS	
Electrical endurance	1H3B type: 1 x 10 ⁶ OPS (16A 250VAC, Resistive load, AgNi, Room temp., 1s on 9s off)	
	2H4B type: 5 x 10 ⁴ OPS (8A 250VAC, Resistive load, AgNi, Room temp., 1s on 9s off)	

CHARACTERISTICS

Insulation resistance	1000MΩ (at 500VDC)	
Dielectric strength	Between coil & contacts	5000VAC 1min
	Between open contacts	1000VAC 1min
	Between contact sets	2500VAC 1min
Surge voltage (between coil & contacts)	10kV (1.2 / 50μs)	
Operate time (at nomi. volt.)	15ms max.	
Release time (at nomi. volt.)	8ms max.	
Temperature rise (at nomi. volt.)	55K max.	
Shock resistance *	Functional	98m/s ²
	Destructive	980m/s ²
Vibration resistance *	10Hz to 150Hz 10g/5g	
Humidity	5% to 85% RH	
Ambient temperature	-40°C to 85°C	
Termination	PCB	
Unit weight	Approx. 13.5g	
Construction	Plastic sealed, Flux proofed	

- Notes:** 1) The data shown above are initial values.
 2) * Index is not in relay length direction.
 3) UL insulation system: Class F, Class B.

COIL

Coil power	Approx. 400mW
------------	---------------

COIL DATA

at 23°C

Nominal Voltage VDC	Pick-up Voltage VDC max.	Drop-out Voltage VDC min.	Max. Voltage VDC 1)	Coil Resistance Ω
5	3.50	0.5	7.5	62 x (1±10%)
6	4.20	0.6	9.0	90 x (1±10%)
9	6.30	0.9	13.5	202 x (1±10%)
12	8.40	1.2	18	360 x (1±10%)
18	12.60	1.8	27	810 x (1±10%)
24	16.80	2.4	36	1440 x (1±10%)
48 ²⁾	33.60	4.8	72	5760 x (1±15%)
60 ²⁾	42.00	6.0	90	7500 x (1±15%)
110 ²⁾	77.00	11.0	165	25200 x (1±15%)

- Notes:** 1) Maximum voltage refers to the maximum voltage which relay coil could endure in a short period of time.
 2) For products with rated voltage ≥ 48V, measures should be taken to prevent coil overvoltage in order to protect coil in test and application (eg. Connect diodes in parallel).



HONGFA RELAY

ISO9001, ISO/TS16949, ISO14001, OHSAS18001, IECQ QC 080000 CERTIFIED

SAFETY APPROVAL RATINGS

VDE

Contact material	Specifications	Ratings	Ambient Temperature
AgCdO	HF115F....2(H;Z)(S)4(G)(F)	8A 250VAC	at 70°C
	HF115F....1H(S)(1;2)(G)(F)	12A 250VAC	at 70°C
		10A 250VAC	at 70°C
	HF115F....1Z(S)(1;2)(G)(F)	12A 250VAC	at 70°C
	HF115F....1H(S)3(G)(F)	16A 250VAC	at 70°C
		10A 250VAC	at 70°C
9A 250VAC COS ϕ =0.4		at 70°C	
HF115F....1Z(S)3(G)(F)	16A 250VAC	at 70°C	
	9A 250VAC COS ϕ =0.4 (NO only)	at 70°C	
AgNi	HF115F....2(H;Z)(S)4B(G)(F)	5A 400VAC	at 85°C
		8A 250VAC	at 85°C
	HF115F....1H(S)(1;2)B(G)(F)	12A 250VAC	at 85°C
	HF115F....1Z(S)(1;2)B(G)(F)	12A 250VAC	at 85°C
	HF115F....1H(S)3B(G)(F)	16A 250VAC	at 85°C
		9A 250VAC COS ϕ =0.4	at 70°C
	HF115F....1Z(S)3B(G)(F)	16A 250VAC (NO only)	at 85°C
		12A 250VAC	at 85°C
9A 250VAC COS ϕ =0.4 (NO only)		at 70°C	
10(4)A 250VAC (NO only)		at 65°C	
	12(2)A 250VAC (NO only)	at 65°C	
AgSnO ₂	HF115F....2(H;Z)(S)4A(G)(F)	8A 250VAC	at 85°C
	HF115F....1(H;Z)(S)(1;2)A(G)(F)	12A 250VAC	at 85°C
	HF115F....1H(S)3A(G)(F)	16A 250VAC	at 85°C
		9A 250VAC COS ϕ =0.4	at 70°C
	HF115F....1Z(S)3A(G)(F)	16A 250VAC (NO only)	at 85°C
	9A 250VAC COS ϕ =0.4 (NO only)	at 70°C	

UL/CUL

Version 1 or 2 (AgCdO)	12A 277VAC	Version 3 (AgSnO ₂)	16A 277 VAC
	1/2HP 250VAC		1/3HP 125VAC
	1/3HP 125VAC		1/2HP 250VAC
Version 1 or 2 (AgSnO ₂)	12A / 277VAC	Version 3 (AgNi)	B300
	B300		R300
	R300		16A 277VAC
Version 1 or 2 (AgNi)	12A 277VAC	Version 4 (AgCdO)	5FLA, 30LRA 250VAC
			10A 250VAC
Version 3 (AgCdO)	16A 277 VAC	Version 4 (AgSnO ₂)	8A 277VAC
	9A 250VAC at 105°C		1/2HP 250VAC
	1HP 250VAC		1/4HP 125VAC
	1/2HP 125VAC		8A 277VAC
	TV-5 125VAC	Version 4 (AgNi)	8A 277VAC

Notes: 1) All values unspecified are at room temperature.

2) Only typical loads are listed above. Other load specifications can be available upon request.

ORDERING INFORMATION

Type	HF115F / 012 -1H S 1 A F (XXX)						
Coil voltage	5, 6, 9, 12, 18, 24, 48, 60, 110VDC						
Contact arrangement	1H: 1 Form A 2H: 2 Form A		1D: 1 Form B 2D: 2 Form B		1Z: 1 Form C 2Z: 2 Form C		
Construction ¹⁾²⁾	S: Plastic sealed			Nil: Flux proofed			
Version	1: 3.5mm 1 pole 12A 3: 5.0mm 1 pole 16A		2: 5.0mm 1 pole 12A 4: 5.0mm 2 pole 8A				
Contact material ³⁾	A: AgSnO ₂ AG: AgSnO ₂ + Au plated		B: AgNi		Nil: AgCdO BG: AgNi+ Au plated		G: AgCdO+ Au plated
Insulation standard	F: Class F		Nil: Class B				
Special code ⁴⁾	XXX: Customer special requirement			Nil: Standard			

- Notes:** 1) We recommend flux proofed types for a clean environment (free from contaminations like H₂S, SO₂, NO₂, dust, etc). We suggest to choose plastic sealed types and validate it in real application for an unclean environment (with contaminations like H₂S, SO₂, NO₂, dust, etc).
- 2) Contact is recommend for suitable condition and specifications if water cleaning or surface process is involved in assembling relays on PCB
- 3) For gold plated type, the min. switching current and min. switching voltage is 10mA 5VDC.
- 4) The customer special requirement express as special code after evaluating by Hongfa. e.g. (335) stands for product in accordance to IEC 60335-1 (GWT); e.g. (253) stands for Reflow soldering version, for 1 pole type.

OUTLINE DIMENSIONS, WIRING DIAGRAM AND PC BOARD LAYOUT

Unit: mm

Outline Dimensions

3.5mm Pinning (HF115F/ □□□ -□□ -□ -1 -□□)

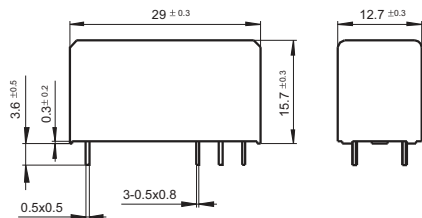

5mm Pinning (HF115F/ □□□ -□□ -□ -2/3/4 -□□)

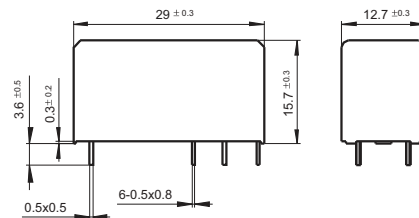

Wiring Diagram (Bottom view)

3.5/5mm Pinning, 1 Pole, 12A, HF115F/ □□□ -1 □ -□ -1/2 -□□



1 Form A



1 Form B

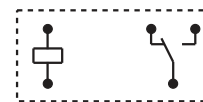

1 Form C

5mm Pinning, 1 Pole, 16A, HF115F/ □□□ -1 □ -□ -3 -□□

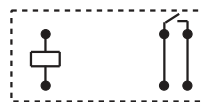

1 Form A

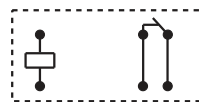

1 Form B

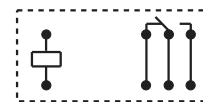

1 Form C

5mm Pinning, 2 Pole, 8A, HF115F/ □□□ -2 □ -□ -4 -□□

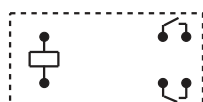

2 Form A

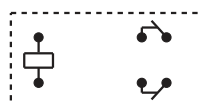

2 Form B

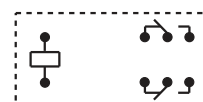

2 Form C

PCB Layout (Bottom view)

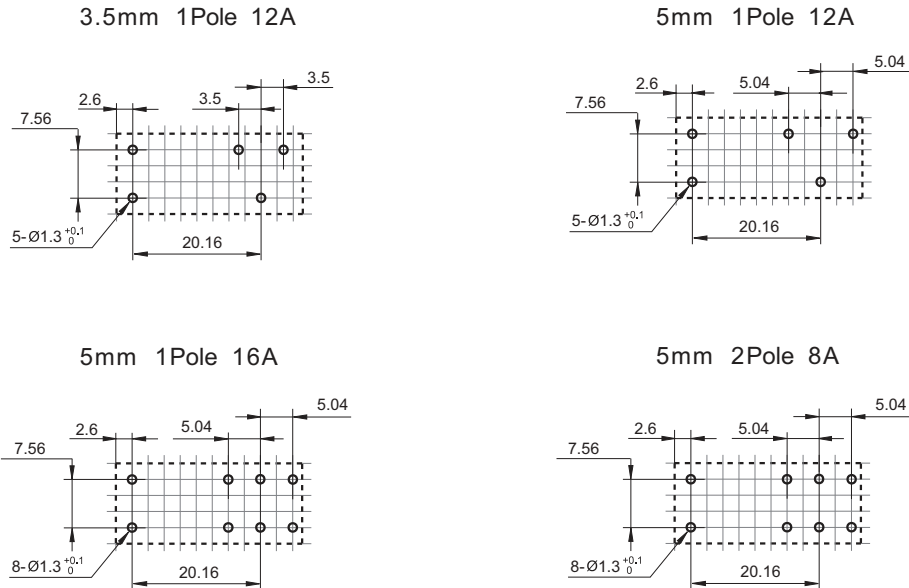

Remark: 1) In case of no tolerance shown in outline dimension: outline dimension $\leq 1\text{mm}$, tolerance should be $\pm 0.2\text{mm}$; outline dimension $> 1\text{mm}$ and $\leq 5\text{mm}$, tolerance should be $\pm 0.3\text{mm}$; outline dimension $> 5\text{mm}$, tolerance should be $\pm 0.4\text{mm}$.
 2) The tolerance without indicating for PCB layout is always $\pm 0.1\text{mm}$.
 3) The width of the gridding is 2.52mm.

CHARACTERISTIC CURVES

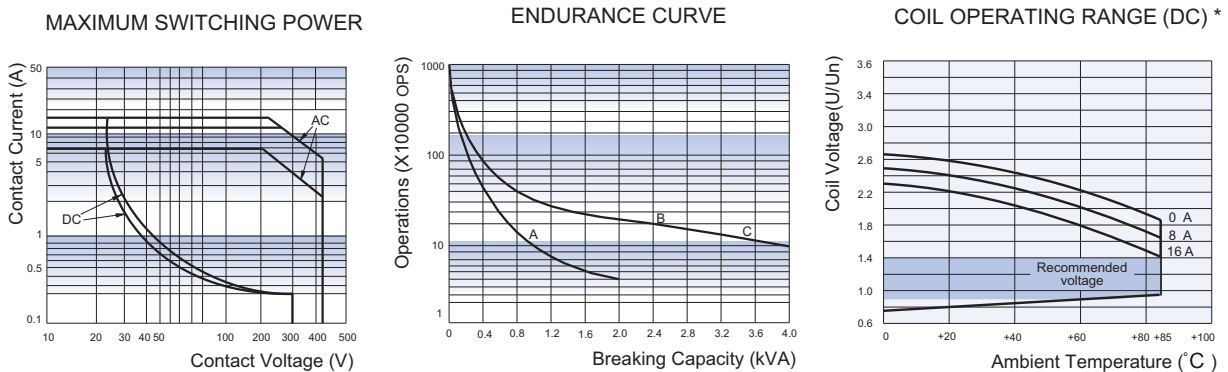

Remark:
 1. Curve A: 2H4B type
 Curve B: 1H1B type(or 1H2B type)
 Curve C: 1H3B type
 2. Test conditions:
 NO, Resistive load, 250VAC,
 Flux proofed, Room temp., 1s on 9s off.

Notes: * The use of a relay with an energising voltage other than the rated coil voltage may lead to reduced electrical life. An energising voltage over the abover range may damage the insulation of relay coil.

Disclaimer

The specification is for reference only. See to "Terminology and Guidelines" for more information. Specifications subject to change without notice. We could not evaluate all the performance and all the parameters for every possible application. Thus the user should be in a right position to choose the suitable product for their own application. If there is any query, please contact Hongfa for the technical service. However, it is the user's responsibility to determine which product should be used only.

HF115F-A

MINIATURE HIGH POWER RELAY



File No.:E134517



File No.:116934



File No.:CQC16002153854



Features

- AC voltage coil type
- 16A switching capability
- 1 & 2 pole configurations
- 5kV dielectric strength (between coil and contacts)
- Low height: 15.7 mm
- Creepage distance: 10mm
- Meeting VDE 0700, 0631 reinforce insulation
- Product in accordance to IEC 60335-1 available
- Sockets available
- Plastic sealed and flux proofed types available
- UL insulation system: Class F
- Environmental friendly product (RoHS compliant)
- Outline Dimensions: (29.0 x 12.7 x 15.7) mm

CONTACT DATA

Contact arrangement	1A, 1B, 1C	2A, 2B, 2C
Contact resistance	100mΩ max.(at 1A 6VDC)	
Contact material	See ordering info.	
Contact rating (Res. load)	12A/16A 250VAC	8A 250VAC
Max. switching voltage	440VAC / 300VDC	
Max. switching current	12A / 16A	8A
Max. switching power	3000VA / 4000VA	2000VA
Mechanical endurance	1 x 10 ⁶ OPS	
Electrical endurance	1H3B type: 5 x 10 ⁴ ops (16A 250VAC, Resistive load, Room temp., 1s on 9s off) 2H4B type: 5 x 10 ⁴ ops (8A 250VAC, Resistive load, Room temp., 1s on 9s off)	

COIL

Coil power	Approx. 0.75VA
------------	----------------

COIL DATA (at 50Hz) at 23°C

Nominal Voltage VAC	Pick-up Voltage VAC max.	Drop-out Voltage VAC min.	Coil Current mA	Coil DC Resistance Ω
24	18.00	3.60	31.6	350 x (1±10%)
115	86.30	17.30	6.6	8100 x (1±15%)
230	172.50	34.50	3.2	32500 x (1±15%)

CHARACTERISTICS

Insulation resistance	1000MΩ (at 500VDC)	
Dielectric strength	Between coil & contacts	5000VAC 1min
	Between open contacts	1000VAC 1min
	Between contact sets	2500VAC 1min
Temperature rise (at nomi. volt.)	85K max.	
Shock resistance *	Functional	98m/s ²
	Destructive	980m/s ²
Vibration resistance *	10Hz to 150Hz 10g/5g	
Humidity	5% to 85% RH	
Ambient temperature	-40°C to 70°C	
Termination	PCB	
Unit weight	Approx. 13.5g	
Construction	Plastic sealed, Flux proofed	

Notes: 1) The data shown above are initial values.
2) * Index is not that of relay length direction.

SAFETY APPROVAL RATINGS

UL/CUL	12A 250VAC
	16A 250VAC
	8A 250VAC
VDE (AgNi, AgNi+Au)	12A 250VAC at 70°C
	16A 250VAC at 70°C
	8A 250VAC at 70°C
VDE (AgSnO ₂ , AgSnO ₂ +Au)	12A 250VAC at 70°C
	8A 250VAC at 70°C

Notes: 1) All values unspecified are at room temperature.
2) Only typical loads are listed above. Other load specifications can be available upon request.



HONGFA RELAY

ISO9001, ISO/TS16949, ISO14001, OHSAS18001, IECQ QC 080000 CERTIFIED

ORDERING INFORMATION

Type	HF115F-A / 024 -1H S 1 A F (XXX)						
Coil voltage	24, 115, 230VAC						
Contact arrangement	1H: 1 Form A 1D: 1 Form B 1Z: 1 Form C 2H: 2 Form A 2D: 2 Form B 2Z: 2 Form C						
Construction ^{1) 2)}	S: Plastic sealed Nil: Flux proofed						
Version	1: 3.5mm 1 pole 12A 2: 5.0mm 1 pole 12A 3: 5.0mm 1 pole 16A 4: 5.0mm 2 pole 8A						
Contact material ³⁾	A: AgSnO ₂ B: AgNi Nil: AgCdO G: AgCdO+Au plated AG: AgSnO ₂ +Au plated BG: AgNi+Au plated						
Insulation standard	F: Class F						
Special code ⁴⁾	XXX: Customer special requirement Nil: Standard						

- Notes:** 1) We recommend flux proofed types for a clean environment (free from contaminations like H₂S, SO₂, NO₂, dust, etc.). We suggest to choose plastic sealed types and validate it in real application for an unclean environment (with contaminations like H₂S, SO₂, NO₂, dust, etc.).
 2) Contact is recommended for suitable condition and specifications if water cleaning or surface process is involved in assembling relays on PCB.
 3) For gold plated type, the min. switching current and min. switching voltage is 10mA 5VDC.
 4) The customer special requirement express as special code after evaluating by Hongfa. e.g.(335) stands for product in accordance to IEC 60335-1 (GWT).

OUTLINE DIMENSIONS, WIRING DIAGRAM AND PC BOARD LAYOUT

Unit: mm

Outline Dimensions

3.5mm Pinning (HF115F-A/ □□□ -□□ -□ -1 -□□)

5mm Pinning (HF115F-A/ □□□ -□□ -□ -2/3/4 -□□)

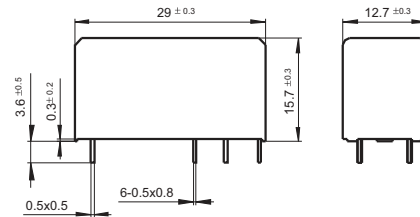
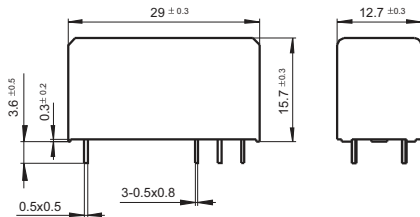

PCB Layout (Bottom view)

3.5mm 1Pole 12A

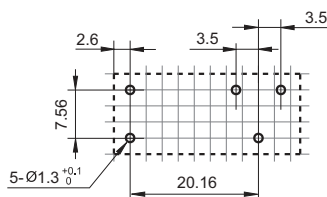

5mm 1Pole 12A

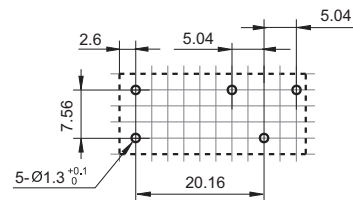

5mm 1Pole 16A

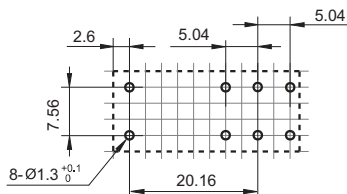

5mm 2Pole 8A

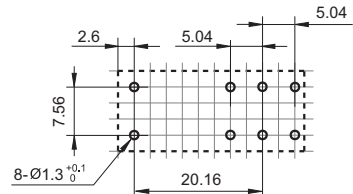

- Remark:** 1) In case of no tolerance shown in outline dimension: outline dimension ≤ 1mm, tolerance should be ±0.2mm; outline dimension > 1mm and ≤ 5mm, tolerance should be ±0.3mm; outline dimension > 5mm, tolerance should be ±0.4mm.
 2) The tolerance without indicating for PCB layout is always ±0.1mm.
 3) The width of the gridding is 2.52mm.

Wiring Diagram (Bottom view)

HF115F-A/ □□□ -□□ -□ -1/2 -□□, 3.5/5mm Pinning, 1 Pole, 12A



1 Form A



1 Form B

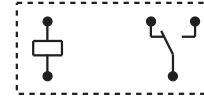

1 Form C

HF115F-A/ □□□ -□□ -□ -3 -□□, 5mm Pinning, 1 Pole, 16A



1 Form A



1 Form B

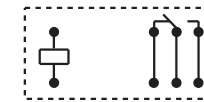

1 Form C

HF115F-A/ □□□ -□□ -□ -4 -□□, 5mm Pinning, 2 Pole, 8A



2 Form A

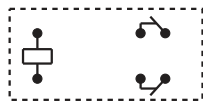

2 Form B

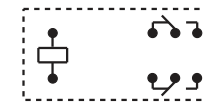

2 Form C

CHARACTERISTIC CURVES

MAXIMUM SWITCHING POWER

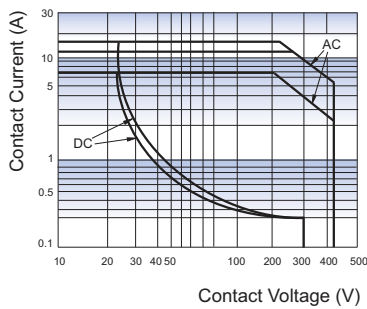

ENDURANCE CURVE

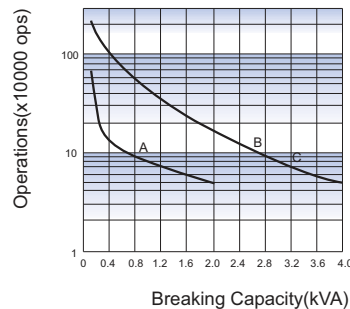

COIL OPERATING RANGE (AC) *

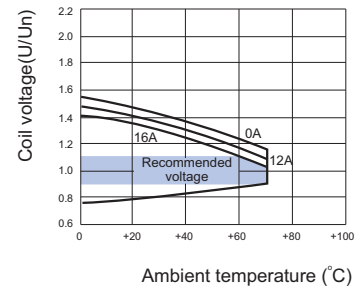

Notes:

- 1) Curve A: 2H4B type
Curve B: 1H1B type (or 1H2B type)
Curve C: 1H3B type
- 2) Test conditions:
NO, Resistive load, 250VAC,
Flux proofed, Room temp., 1s on 9s off.

Notes: * The use of a relay with an energising voltage other than the rated coil voltage may lead to reduced electrical life.

An energising voltage over the abver range may damage the insulation of relay coil.

Disclaimer

The specification is for reference only. See to "Terminology and Guidelines" for more information. Specifications subject to change without notice. We could not evaluate all the performance and all the parameters for every possible application. Thus the user should be in a right position to choose the suitable product for their own application. If there is any query, please contact Hongfa for the technical service. However, it is the user's responsibility to determine which product should be used only.

HF115F-T/TH

MINIATURE HIGH POWER RELAY



File No.: E134517



File No.: 116934



File No.: CQC08002028130



Features

- High Temperature: 105°C
- Low height 15.7 mm
- 5kV dielectric strength (between coil and contacts)
- Creepage distance: 10mm
- Meeting VDE 0700, 0631 reinforce insulation
- Product in accordance to IEC 60335-1 available
- UL insulation system: Class F
- Sockets available
- Plastic sealed and flux proofed types available
- Environmental friendly product (RoHS compliant)
- Outline Dimensions: (29.0 x 12.7 x 15.7) mm

CONTACT DATA

Contact arrangement	1A, 1C
Contact resistance	100mΩ max.(at 1A 6VDC)
Contact material	See ordering info.
Contact rating (Res. load)	HF115F-TH: 10A 250VAC HF115F-T: 16A 250VAC
Max. switching voltage	440VAC / 300VDC
Max. switching current	HF115F-TH:10A HF115F-T:16A
Max. switching power	HF115F-TH: 2500VA HF115F-T: 4000VA
Mechanical endurance	1 x 10 ⁷ ops
Electrical endurance	HF115F-T 1H3B type: 5 x 10 ⁴ ops (16A 250VAC, Resistive load, at 105°C, 5s on 5s off) HF115F-TH 1H3B type: 5 x 10 ⁴ ops (10A 250VAC, Resistive load, at 105°C, 5s on 5s off)

COIL

Coil power	HF115F-TH: Approx. 250mW; HF115F-T: Approx. 400mW
------------	--

COIL DATA

at 23°C

Standard type (HF115F-T)

Nominal Voltage VDC	Pick-up Voltage VDC max.	Drop-out Voltage VDC min.	Max. Voltage VDC ¹⁾	Coil Resistance Ω
5	3.50	0.5	6.5	62 x (1±10%)
6	4.20	0.6	7.8	90 x (1±10%)
9	6.30	0.9	11.7	202 x (1±10%)
12	8.40	1.2	15.6	360 x (1±10%)
18	12.6	1.8	23.4	810 x (1±10%)
24	16.8	2.4	31.2	1440 x (1±10%)
48 ²⁾	33.6	4.8	62.4	5760 x (1±15%)
60 ²⁾	42.0	6.0	78	7500 x (1±15%)

Sensitive type (HF115F-TH)

Nominal Voltage VDC	Pick-up Voltage VDC max.	Drop-out Voltage VDC min.	Max. Voltage VDC ¹⁾	Coil Resistance Ω
5	3.75	0.5	6.5	100 x (1±10%)
6	4.50	0.6	7.8	144 x (1±10%)
9	6.75	0.9	11.7	324 x (1±10%)
12	9.00	1.2	15.6	576 x (1±10%)
18	13.50	1.8	23.4	1296 x (1±10%)
24	18.00	2.4	31.2	2304 x (1±10%)
48 ²⁾	36.00	4.8	62.4	9216 x (1±15%)
60 ²⁾	45.00	6.0	78	12857 x (1±15%)

Notes: 1) Maximum voltage refers to the maximum voltage which relay coil could endure in a short period of time.

2) For products with rated voltage ≥ 48V, measures should be taken to prevent coil overvoltage in order to protect coil in test and application (eg. Connect diodes in parallel).

CHARACTERISTICS

Insulation resistance	1000MΩ (at 500VDC)	
Dielectric strength	Between coil & contacts	5000VAC 1min
	Between open contacts	1000VAC 1min
Surge voltage (between coil & contacts)	10kV (1.2 / 50μs)	
Operate time (at nomi. volt.)	15ms max.	
Release time (at nomi. volt.)	8ms max.	
Temperature rise (at nomi. volt.)	55K max.	
Shock resistance *	Functional	98m/s ²
	Destructive	980m/s ²
Vibration resistance *	10Hz to 150Hz 10g/5g	
Humidity	5% to 85% RH	
Ambient temperature	-40°C to 105°C	
Termination	PCB	
Unit weight	Approx. 13.5g	
Construction	Plastic sealed, Flux proofed	

Notes: 1) The data shown above are initial values.

2) * Index is not that of relay length direction.



HONGFA RELAY

ISO9001, ISO/TS16949, ISO14001, OHSAS18001, IECQ QC 080000 CERTIFIED

SAFETY APPROVAL RATINGS

VDE	HF115F-T-1H(S)3A	18.4A 250VAC at 105°C
	HF115F-TH -1H(S)3	10A 250VAC at 105°C 6A 400VAC at 105°C
	HF115F-T-1H(S)3B	16A 250VAC at 105°C
	HF115F-TH -1H(S)3B	10A 250VAC at 105°C
	HF115F-T-1Z(S)3B	NO: 16A 250VAC at 105°C NC: 5A 250VAC at 105°C
UL/CUL	HF115F-TH -1H(S)3B	10A 277VAC
	HF115F-TH -1H(S)3A	10A 277VAC
	HF115F-T-1H(S)3B	16A 277VAC
	HF115F-T-1H(S)3A	16A 250VAC

Notes: 1) All values unspecified are at room temperature.

2) Only typical loads are listed above. Other load specifications can be available upon request.

ORDERING INFORMATION

HF115F-T/TH 012 -1H S 3 A (XXX)	
Type	HF115F-T: Standard HF115F-TH: High Sensitive
Coil voltage	5, 6, 9, 12, 18, 24, 48, 60VDC
Contact arrangement	1H: 1 Form A 1Z: 1 Form C
Construction ¹⁾²⁾	S: Plastic sealed Nil: Flux proofed
Version	3: 5.0mm
Contact material	A: AgSnO ₂ B: AgNi Nil: AgCdO
Special code ³⁾	XXX: Customer special requirement Nil: Standard

Notes: 1) We recommend flux proofed types for a clean environment (free from contaminations like H₂S, SO₂, NO₂, dust, etc.).

We suggest to choose plastic sealed types and validate it in real application for an unclean environment (with contaminations like H₂S, SO₂, NO₂, dust, etc.).

2) Contact is recommended for suitable condition and specifications if water cleaning or surface process is involved in assembling relays on PCB.

3) The customer special requirement express as special code after evaluating by Hongfa. e.g.(335) stands for product in accordance to IEC 60335-1 (GWT).

OUTLINE DIMENSIONS, WIRING DIAGRAM AND PC BOARD LAYOUT

Unit: mm

Outline Dimensions

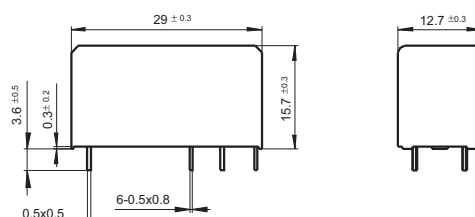

OUTLINE DIMENSIONS, WIRING DIAGRAM AND PC BOARD LAYOUT

Unit: mm

PCB Layout
(Bottom view)

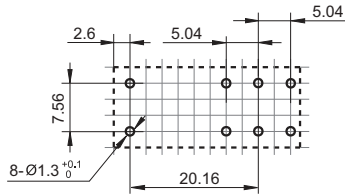

Wiring Diagram
(Bottom view)



- Remark: 1) In case of no tolerance shown in outline dimension: outline dimension $\leq 1\text{mm}$, tolerance should be $\pm 0.2\text{mm}$; outline dimension $> 1\text{mm}$ and $\leq 5\text{mm}$, tolerance should be $\pm 0.3\text{mm}$; outline dimension $> 5\text{mm}$, tolerance should be $\pm 0.4\text{mm}$.
 2) The tolerance without indicating for PCB layout is always $\pm 0.1\text{mm}$.
 3) The width of the gridding is 2.52mm.

CHARACTERISTIC CURVES

ENDURANCE CURVE

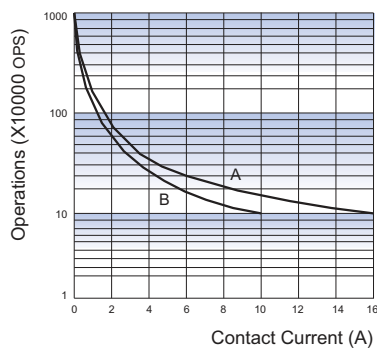

Notes:

- Curve A: HF115F-T 1H3B type
Curve B: HF115F-TH 1H3B type
- Test conditions:
NO, Resistive load, 250VAC, Flux proofed,
Room temp., 1s on 9s off

COIL OPERATING RANGE (DC) *

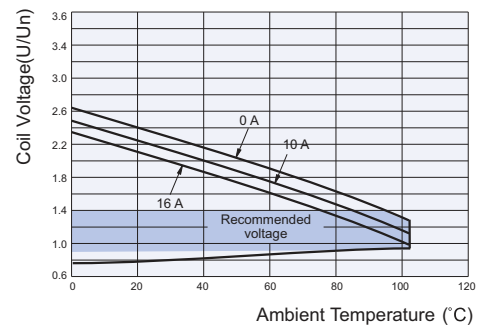

- Notes:** * The use of a relay with an energising voltage other than the rated coil voltage may lead to reduced electrical life.
 An energising voltage over the above range may damage the insulation of relay coil.

Disclaimer

The specification is for reference only. See to "Terminology and Guidelines" for more information. Specifications subject to change without notice. We could not evaluate all the performance and all the parameters for every possible application. Thus the user should be in a right position to choose the suitable product for their own application. If there is any query, please contact Hongfa for the technical service. However, it is the user's responsibility to determine which product should be used only.

© Xiamen Hongfa Electroacoustic Co., Ltd. All rights of Hongfa are reserved.

HF115F-H

MINIATURE HIGH POWER RELAY



File No.:E134517



File No.:116934



File No.:CQC08002028130



Features

- High sensitive: 0.25W
- Low height: 15.7 mm
- 5kV dielectric strength (between coil and contacts)
- Creepage distance: 10mm
- Meeting VDE 0700, 0631 reinforce insulation
- Product in accordance to IEC 60335-1 available
- Sockets available
- Plastic sealed and flux proofed types available
- UL insulation system: Class F available
- Environmental friendly product (RoHS compliant)
- Outline Dimensions: (29.0 x 12.7 x 15.7) mm

CONTACT DATA

Contact arrangement	1A, 1B, 1C
Contact resistance	100mΩ max.(at 1A 6VDC)
Contact material	See ordering info.
Contact rating (Sensitive coil)	10A 250VAC
Max. switching voltage	440VAC / 300VDC
Max. switching current	10A
Max. switching power	2500VA
Mechanical endurance	1 x 10 ⁷ OPS
Electrical endurance	1H3 type: 1 x 10 ⁵ OPS (10A 250VAC, Resistive load, at 85°C, 5s on 5s off)

CHARACTERISTICS

Insulation resistance	1000MΩ (at 500VDC)	
Dielectric strength	Between coil & contacts	5000VAC 1min
	Between open contacts	1000VAC 1min
Surge voltage (between coil & contacts)	10kV (1.2 / 50μs)	
Operate time (at nomi. volt.)	15ms max.	
Release time (at nomi. volt.)	8ms max.	
Temperature rise (at nomi. volt.)	55K max.	
Shock resistance *	Functional	98m/s ²
	Destructive	980m/s ²
Vibration resistance *	10Hz to 150Hz 10g/5g	
Humidity	5% to 85% RH	
Ambient temperature	-40°C to 85°C	
Termination	PCB	
Unit weight	Approx. 13.5g	
Construction	Plastic sealed, Flux proofed	

- Notes:** 1) The data shown above are initial values.
 2) * Index is not that of relay length direction.
 3) UL insulation system: Class F, Class B.

COIL

Coil power	Approx. 250mW
------------	---------------

COIL DATA

at 23°C

Nominal Voltage VDC	Pick-up Voltage VDC max.	Drop-out Voltage VDC min.	Max. Voltage VDC ¹⁾	Coil Resistance Ω
5	3.75	0.5	7.5	100 x (1±10%)
6	4.50	0.6	9.0	144 x (1±10%)
12	9.00	1.2	18	576 x (1±10%)
18	13.50	1.8	27	1296 x (1±10%)
24	18.00	2.4	36	2304 x (1±10%)
48 ²⁾	36.00	4.8	72	9216 x (1±15%)
60 ²⁾	45.00	6.0	90	12857 x (1±15%)

- Notes:** 1) Maximum voltage refers to the maximum voltage which relay coil could endure in a short period of time.
 2) For products with rated voltage ≥ 48V, measures should be taken to prevent coil overvoltage in order to protect coil in test and application (eg. Connect diodes in parallel).



HONGFA RELAY

ISO9001, ISO/TS16949, ISO14001, OHSAS18001, IECQ QC 080000 CERTIFIED

SAFETY APPROVAL RATINGS

VDE

Contact Material	Specifications	Ratings
AgSnO ₂	HF115F-H....1(H;Z)(S)(1;2;3)A(G)(F)	10A 250VAC at 85°C
AgCdO	HF115F-H....1(H;Z)(S)(1;2;3)(G)(F)	10A 250VAC at 85°C 6A 400VAC at 85°C

UL/CUL

Contact Material	Specifications	Ratings
AgCdO	HF115F-H....1(H;Z)(S)(1;2;3)(G)(F)	10A 250VAC

Notes: 1) All values unspecified are at room temperature.

2) Only typical loads are listed above. Other load specifications can be available upon request.

ORDERING INFORMATION

Type	HF115F-H / 012 -1H S 3 A F (XXX)
Coil voltage	5, 6, 12, 18, 24, 48, 60VDC
Contact arrangement	1H:1 Form A 1D:1 Form B 1Z:1 Form C
Construction ^{1) 2)}	S: Plastic sealed Nil: Flux proofed
Version	1: 3.5mm 1 pole 2: 5.0mm 1 pole 3: 5.0mm 1 pole
Contact materia ³⁾	A: AgSnO ₂ B: AgNi Nil: AgCdO G: AgCdO+Au plated AG: AgSnO ₂ +Au plated BG: AgNi+Au plated
Insulation standard	F: Class F Nil: Class B
Special code ⁴⁾	XXX: Customer special requirement Nil: Standard

Notes: 1) We recommend flux proofed types for a clean environment (free from contaminations like H₂S, SO₂, NO₂, dust, etc.).

We suggest to choose plastic sealed types and validate it in real application for an unclean environment (with contaminations like H₂S, SO₂, NO₂, dust, etc.).

- Contact is recommended for suitable condition and specifications if water cleaning or surface process is involved in assembling relays on PCB.
- For gold plated type, the min. switching current and min. switching voltage is 10mA 5VDC.
- The customer special requirement express as special code after evaluating by Hongfa. e.g.(335) stands for product in accordance to IEC 60335-1 (GWT).

OUTLINE DIMENSIONS, WIRING DIAGRAM AND PC BOARD LAYOUT

Unit: mm

Outline Dimensions

3.5mm Pinning (HF115F-H/ □□□ -□□ -1-□)

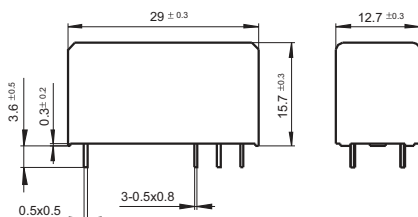

5mm Pinning (HF115F-H/ □□□ -□□-2/3-□)

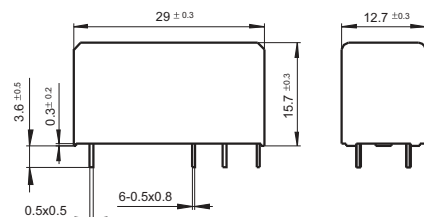

OUTLINE DIMENSIONS, WIRING DIAGRAM AND PC BOARD LAYOUT

Unit: mm

PCB Layout (Bottom view)

3.5mm Pinning, 1 Pole

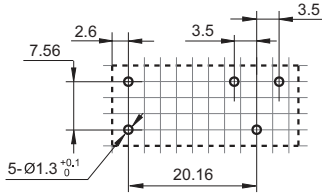

5mm Pinning, 1 Pole

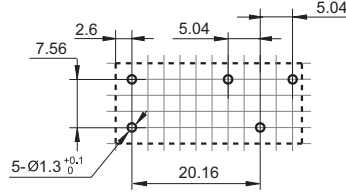

5mm Pinning, 1 Pole

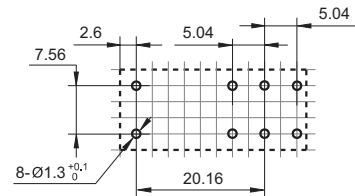

Wiring Diagram (Bottom view)

3.5/5mm Pinning, 1 Pole, 10A, HF115F-H/ □□□ -□□ -□ -1/2 -□



1 Form A



1 Form B

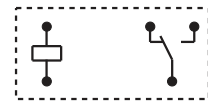

1 Form C

5mm Pinning, 1 Pole, 10A, HF115F-H/ □□□ -□□ -□ -3 -□



1 Form A



1 Form B

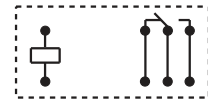

1 Form C

- Remark: 1) In case of no tolerance shown in outline dimension: outline dimension $\leq 1\text{mm}$, tolerance should be $\pm 0.2\text{mm}$; outline dimension $> 1\text{mm}$ and $\leq 5\text{mm}$, tolerance should be $\pm 0.3\text{mm}$; outline dimension $> 5\text{mm}$, tolerance should be $\pm 0.4\text{mm}$.
 2) The tolerance without indicating for PCB layout is always $\pm 0.1\text{mm}$.
 3) The width of the gridding is 2.52mm.

CHARACTERISTIC CURVES

ENDURANCE CURVE

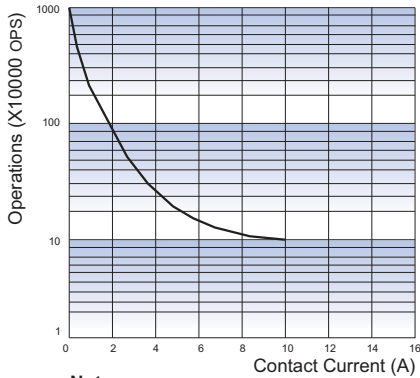

Notes:

- 1) Curve : 1H3 type
- 2) Test conditions:
NO, 250VAC, Resistive load,
Flux proofed, at 85°C, 5s on 5s off.

COIL OPERATING RANGE (DC) *

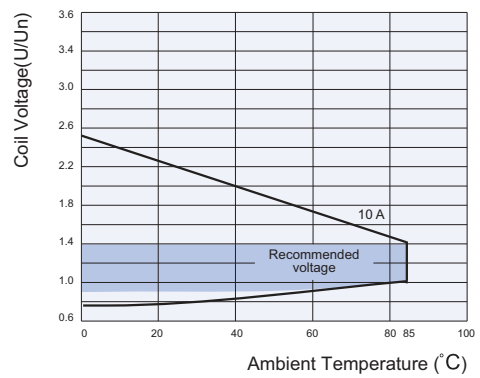

- Notes:** * The use of a relay with an energising voltage other than the rated coil voltage may lead to reduced electrical life.
 An energising voltage over the above range may damage the insulation of relay coil.

Disclaimer

The specification is for reference only. See to "Terminology and Guidelines" for more information. Specifications subject to change without notice. We could not evaluate all the performance and all the parameters for every possible application. Thus the user should be in a right position to choose the suitable product for their own application. If there is any query, please contact Hongfa for the technical service. However, it is the user's responsibility to determine which product should be used only.

HF115F-I

MINIATURE HIGH POWER RELAY



File No.:E134517



File No.:116934



File No.:CQC08002028130



Features

- Max high inrush:120A 20ms
- Low height: 15.7 mm
- 5kV dielectric strength (between coil and contacts)
- Creepage distance: 10mm
- Meeting VDE 0700, 0631 reinforce insulation
- Product in accordance to IEC 60335-1 available
- Sockets available
- Plastic sealed and flux proofed types available
- UL insulation system: Class F
- Environmental friendly product (RoHS compliant)
- Outline Dimensions: (29.0 x 12.7 x 15.7) mm

CONTACT DATA

Contact arrangement	1A, 1C
Contact resistance	100mΩ max.(at 1A 6VDC)
Contact material	AgSnO ₂
Contact rating	16A 250VAC
Inrush rating (120VAC)	NO: TV-5 80A 120A / 20ms
Max. switching voltage	440VAC / 300VDC
Max. switching current	16A
Max. switching power	4000VA
Mechanical endurance	1 x 10 ⁷ ops
Electrical endurance	1H3A type: 7.5 x 10 ⁴ ops (16A 250VAC, General use, Room temp., 1s on 9s off) 1H3A type: 2.5 x 10 ⁴ ops (TV-5 120VAC, Room temp., 1s on 59s off)

COIL

Coil power	Approx. 400mW
------------	---------------

COIL DATA

at 23°C

Nominal Voltage VDC	Pick-up Voltage VDC max.	Drop-out Voltage VDC min.	Max. Voltage VDC ¹⁾	Coil Resistance Ω
5	3.50	0.5	7.5	62 x (1±10%)
6	4.20	0.6	9.0	90 x (1±10%)
9	6.30	0.9	13.5	202 x (1±10%)
12	8.40	1.2	18	360 x (1±10%)
18	12.6	1.8	27	810 x (1±10%)
24	16.8	2.4	36	1440 x (1±10%)
48 ²⁾	33.6	4.8	72	5760 x (1±15%)
60 ²⁾	42.0	6.0	90	7500 x (1±15%)
110 ²⁾	77.0	11.0	165	25200 x (1±15%)

Notes: 1) Maximum voltage refers to the maximum voltage which relay coil could endure in a short period of time.

2) For products with rated voltage ≥ 48V, measures should be taken to prevent coil overvoltage in order to protect coil in test and application (eg. Connect diodes in parallel).

CHARACTERISTICS

Insulation resistance	1000MΩ (at 500VDC)	
Dielectric strength	Between coil & contacts	5000VAC 1min
	Between open contacts	1000VAC 1min
Surge voltage (between coil & contacts)	10kV (1.2 / 50μs)	
Operate time (at nomi. volt.)	15ms max.	
Release time (at nomi. volt.)	8ms max.	
Temperature rise (at nomi. volt.)	55K max.	
Shock resistance *	Functional	98m/s ²
	Destructive	980m/s ²
Vibration resistance *	10Hz to 150Hz 20g/5g	
Humidity	5% to 85% RH	
Ambient temperature	-40°C to 85°C	
Termination	PCB	
Unit weight	Approx. 13.5g	
Construction	Plastic sealed, Flux proofed	

Notes: 1) The data shown above are initial values.
2) * Index is not that of relay length direction.

SAFETY APPROVAL RATINGS

UL/CUL	HF115F-I....1Z(S)3A	NO: 16A 250VAC at 85°C
	HF115F-I....1H(S)3A	16A 250VAC TV-5, 120VAC
VDE	HF115F-I....1H(S)3A	16A 250VAC at 85°C
	HF115F-I....1Z(S)3A	NO: 16A 250VAC at 85°C

Notes: 1) All values unspecified are at room temperature.
2) Only typical loads are listed above. Other load specifications can be available upon request.



HONGFA RELAY

ISO9001, ISO/TS16949, ISO14001, OHSAS18001, IECQ QC 080000 CERTIFIED

ORDERING INFORMATION

Type		HF115F-I / 012		-1H	S	3	A	(XXX)
Coil voltage	5, 6, 9, 12, 18, 24, 48, 60, 110VDC							
Contact arrangement	1H: 1 Form A		1Z: 1 Form C					
Construction ¹⁾²⁾	S: Plastic sealed		Nil: Flux proofed					
Version	3: 5.0mm							
Contact material	A: AgSnO ₂							
Special code ³⁾	XXX: Customer special requirement			Nil: Standard				

- Notes:** 1) We recommend flux proofed types for a clean environment (free from contaminations like H₂S, SO₂, NO₂, dust, etc.). We suggest to choose plastic sealed types and validate it in real application for an unclean environment (with contaminations like H₂S, SO₂, NO₂, dust, etc.).
- 2) Contact is recommended for suitable condition and specifications if water cleaning or surface process is involved in assembling relays on PCB.
- 3) The customer special requirement express as special code after evaluating by Hongfa. e.g.(335) stands for product in accordance to IEC 60335-1 (GWT).

OUTLINE DIMENSIONS, WIRING DIAGRAM AND PC BOARD LAYOUT

Unit: mm

Outline Dimensions

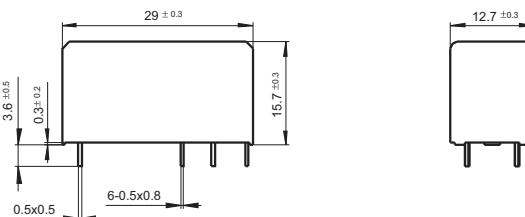

PCB Layout (Bottom view)

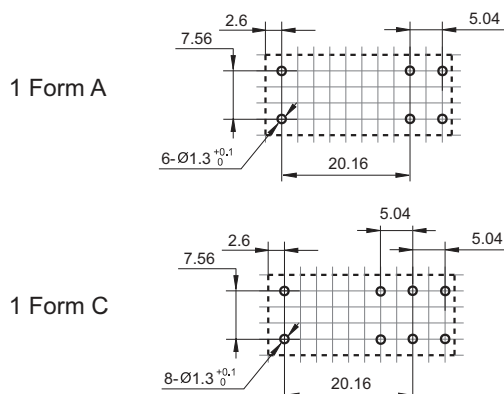

Wiring Diagram (Bottom view)

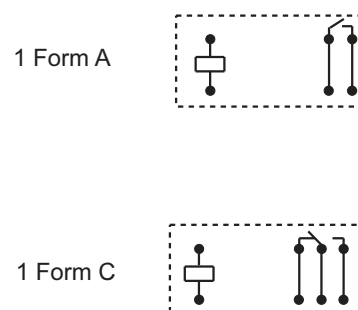

- Remark: 1) In case of no tolerance shown in outline dimension: outline dimension ≤ 1 mm, tolerance should be ± 0.2 mm; outline dimension > 1 mm and ≤ 5 mm, tolerance should be ± 0.3 mm; outline dimension > 5 mm, tolerance should be ± 0.4 mm.
- 2) The tolerance without indicating for PCB layout is always ± 0.1 mm.
- 3) The width of the gridding is 2.52mm.

CHARACTERISTIC CURVES

ENDURANCE CURVE

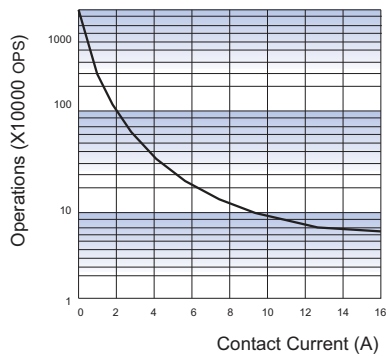

Test conditions:
 NO, 250VAC, Resistance Load,
 Flux proofed, Room temp., 1s on 9s off

COIL OPERATING RANGE (DC) *

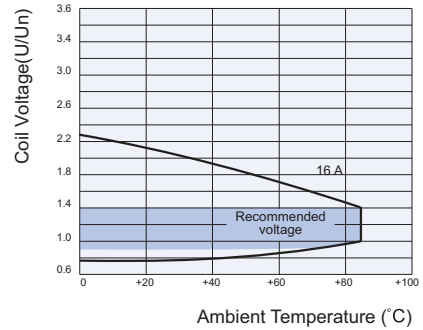

Notes: * The use of a relay with an energising voltage other than the rated coil voltage may lead to reduced electrical life. An energising voltage over the abver range may damage the insulation of relay coil.

Disclaimer

The specification is for reference only. See to "Terminology and Guidelines" for more information. Specifications subject to change without notice. We could not evaluate all the performance and all the parameters for every possible application. Thus the user should be in a right position to choose the suitable product for their own application. If there is any query, please contact Hongfa for the technical service. However, it is the user's responsibility to determine which product should be used only.

© Xiamen Hongfa Electroacoustic Co., Ltd. All rights of Hongfa are reserved.

HF115F-Q

MINIATURE HIGH POWER RELAY



File No.: E134517



File No.: 116934



File No.: CQC08002028130



Features

- Ambient temperature up to 125 °C
- 5kV dielectric strength (between coil and contacts)
- Low height: 15.7mm
- Creepage distance >8mm
- Meeting VDE 0700, 0631 reinforce insulation
- UL94, V-0 flammability class
- Product in accordance to IEC 60335-1 available
- UL insulation system: Class F
- Environmental friendly product (RoHS compliant)
- Outline Dimensions: Vertical: (41.0 x 12.7 x 15.7) mm
Horizontal: (45.0 x 12.7 x 15.7) mm

CONTACT DATA

Contact arrangement	1A, 1B
Contact resistance	100mΩ max.(at 1A 6VDC)
Contact material	AgSnO ₂ , AgNi
Contact rating	20A 250VAC
Max. switching voltage	440VAC / 300VDC
Max. switching current	20A
Max. switching power	5000VA
Mechanical endurance	1 x 10 ⁷ OPS
Electrical endurance	1H type: 3 x 10 ⁴ OPS (20A 277VAC, Resistive load, Room temp., 1s on 9s off)

CHARACTERISTICS

Insulation resistance		1000MΩ (at 500VDC)
Dielectric strength	Between coil & contacts	5000VAC 1min
	Between open contacts	1000VAC 1min
Surge voltage (between coil & contacts)		10kV (1.2 / 50μs)
Operate time (at nomi. volt.)		15ms max.
Release time (at nomi. volt.)		8ms max.
Temperature rise (at nomi. volt.)		55K max.
Shock resistance *	Functional	98m/s ²
	Destructive	980m/s ²
Vibration resistance *		1A: 10Hz to150Hz 10g 1B: 10Hz to150Hz 5g
Humidity		5% to 85% RH
Ambient temperature		-40°C to 125°C
Termination		PCB & QC
Unit weight		Approx. 16g
Construction		Flux proofed

Notes: 1) The data shown above are initial values.
2) * Index is not that of relay length direction.

COIL

Coil power	Approx. 400mW
------------	---------------

COIL DATA

at 23°C

Nominal Voltage VDC	Pick-up Voltage VDC max.	Drop-out Voltage VDC min.	Max. Voltage VDC ¹⁾	Coil Resistance Ω
5	3.50	0.5	7.5	62 x (1±10%)
6	4.20	0.6	9.0	90 x (1±10%)
9	6.30	0.9	13.5	202 x (1±10%)
12	8.40	1.2	18.0	360 x (1±10%)
18	12.6	1.8	27.0	810 x (1±10%)
24	16.8	2.4	36.0	1440 x (1±10%)
48 ²⁾	33.6	4.8	72.0	5760 x (1±15%)
60 ²⁾	42.0	6.0	90.0	7500 x (1±15%)

Notes: 1) Maximum voltage refers to the maximum voltage which relay coil could endure in a short period of time.

2) For products with rated voltage ≥ 48V, measures should be taken to prevent coil overvoltage in order to protect coil in test and application (eg. Connect diodes in parallel).

SAFETY APPROVAL RATINGS

VDE	AgNi	1 Form A	18A 250VAC at 105°C 16A 250VAC at 125°C 12A 400VAC at 105°C
		1 Form B	16A 250VAC at 125°C 12A 400VAC at 105°C
UL/CUL	AgNi	1 Form A 1 Form B	20A 277VAC

Notes: 1) All values unspecified are at room temperature.
2) Only typical loads are listed above. Other load specifications can be available upon request.



HONGFA RELAY

ISO9001, ISO/TS16949, ISO14001, OHSAS18001, IECQ QC 080000 CERTIFIED

ORDERING INFORMATION

Type	HF115F-Q / 012 -1H 3 T (XXX)				
Coil voltage	5, 6, 9, 12, 18, 24, 48, 60VDC				
Contact arrangement	1H: 1 Form A	1D: 1 Form B			
Terminals	3: Quick connect terminals horizontal		Nil: Quick connect terminals vertical		
Contact material	T: AgSnO ₂	Nil: AgNi			
Special code ³⁾	XXX: Customer special requirement		Nil: Standard		

- Notes: 1) Flux-proofed relays can not be used in the environment with pollutants like H₂S, SO₂, NO₂, dust, etc.
 2) Water cleaning or surface process is not suggested after the flux-proofed relays are assembled on PCB.
 3) The customer special requirement express as special code after evaluating by Hongfa. e.g.(335) stands for product in accordance to IEC 60335-1 (GWT).

OUTLINE DIMENSIONS, WIRING DIAGRAM AND PC BOARD LAYOUT

Unit: mm

Outline Dimensions

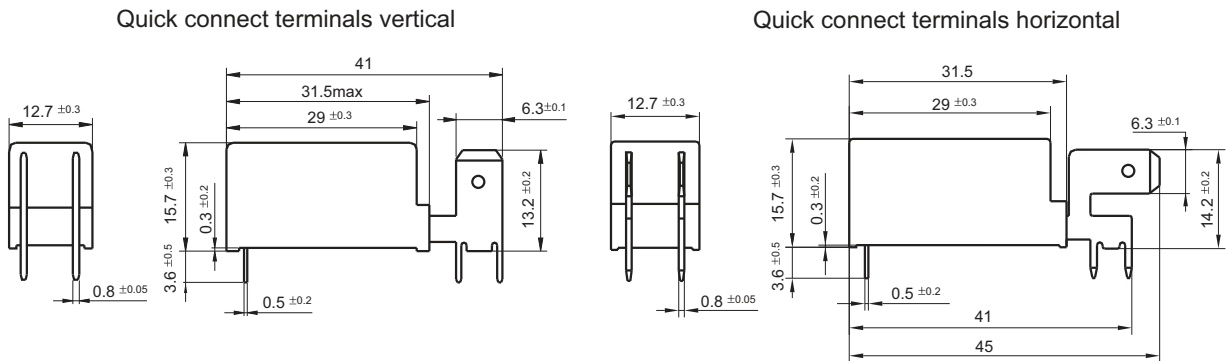

Wiring Diagram (Bottom view)

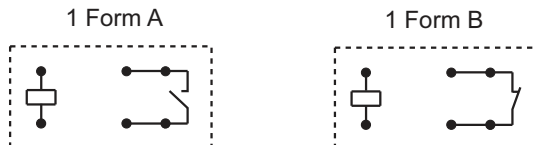

PCB Layout (Bottom view)

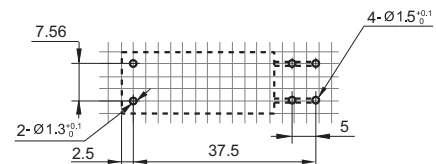

- Remark: 1) In case of no tolerance shown in outline dimension: outline dimension ≤1mm, tolerance should be ±0.2mm; outline dimension > 1mm and ≤5mm, tolerance should be ±0.3mm; outline dimension > 5mm, tolerance should be ±0.4mm.
 2) The tolerance without indicating for PCB layout is always ±0.1mm.
 3) The width of the gridding is 2.52mm.

CHARACTERISTIC CURVES

MAXIMUM SWITCHING POWER

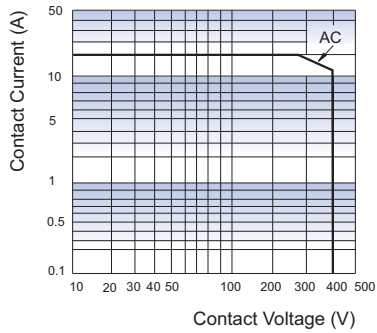

ENDURANCE CURVE

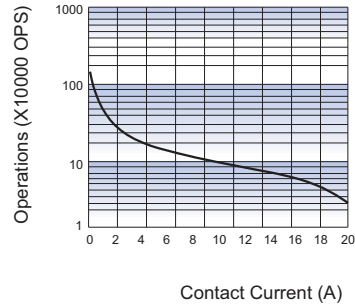

COIL OPERATING RANGE (DC) *

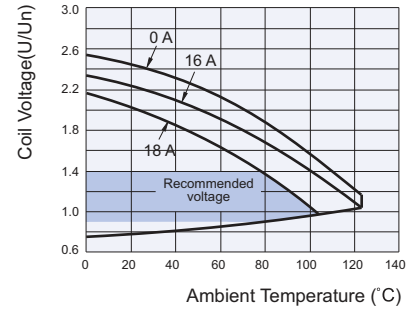

Notes:

- 1) Curve: 1H type
- 2) Test conditions:
NO, 250VAC, Resistive load, Flux proofed,
Room temp., 1s on 9s off.

- Notes:** * The use of a relay with an energising voltage other than the rated coil voltage may lead to reduced electrical life. An energising voltage over the abover range may damage the insulation of relay coil.

Disclaimer

The specification is for reference only. See to "Terminology and Guidelines" for more information. Specifications subject to change without notice. We could not evaluate all the performance and all the parameters for every possible application. Thus the user should be in a right position to choose the suitable product for their own application. If there is any query, please contact Hongfa for the technical service. However, it is the user's responsibility to determine which product should be used only.

HF115F-S

MINIATURE HIGH POWER RELAY



File No.:E134517



File No.:116934



File No.:CQC08002028130



Features

- Special contact struction
- Incandescent lamp load: 3000W 230VAC
- 5kV dielectric strength (between coil and contacts)
- Creepage distance: 11mm
- Low height: 15.7 mm
- Meeting reinforce insulation
- Product in accordance to IEC 60335-1 available
- Plastic sealed and flux proofed types available
- UL insulation system: Class F available
- Environmental friendly product (RoHS compliant)
- Outline Dimensions: (29.0 x 12.7 x 15.7) mm

CONTACT DATA

Contact arrangement	1A
Contact resistance	100mΩ max.(at 1A 6VDC)
Contact material	W+AgSnO ₂
Contact rating	Resistive:16A 250VAC Incandescent Lamp: 3000W 230VAC Inrush current: 165A / 20ms flourescent: 800A/200μs
Max. switching voltage	440VAC
Max. switching current	16A
Max. switching power	4000VA
Mechanical endurance	5 x 10 ⁶ OPS
Electrical endurance	1.2 x 10 ⁴ OPS (3000W 230VAC, Incand escentlamp load, Room temp., 1s on 59s off)

CHARACTERISTICS

Insulation resistance	1000MΩ (at 500VDC)	
Dielectric strength	Between coil & contacts	5000VAC 1min
	Between open contacts	1250VAC 1min
Surge voltage (between coil & contacts)	10kV (1.2 / 50μs)	
Operate time (at nomi. volt.)	10ms max.	
Release time (at nomi. volt.)	5ms max.	
Temperature rise (at nomi. volt.)	55K max.	
Shock resistance *	Functional	98m/s ²
	Destructive	980m/s ²
Vibration resistance *	10Hz to 150Hz 10g	
Humidity	5% to 85% RH	
Ambient temperature	-40°C to 85°C	
Termination	PCB	
Unit weight	Approx. 13.5g	
Construction	Plastic sealed, Flux proofed	

- Notes:**1) This contact resistance value is tested under the nominal voltage.
2) * Index is not that of relay length direction.
3) The data shown above are initial values.
4) UL insulation system: Class F, Class B.

COIL

Coil power	Approx. 400mW
------------	---------------

COIL DATA

at 23°C

Nominal Voltage VDC	Pick-up Voltage VDC max.	Drop-out Voltage VDC min.	Max. Voltage VDC ¹⁾	Coil Resistance Ω
5	3.50	0.5	7.5	62 x (1±10%)
6	4.20	0.6	9.0	90 x (1±10%)
9	6.30	0.9	13.5	202 x (1±10%)
12	8.40	1.2	18	360 x (1±10%)
18	12.6	1.8	27	810 x (1±10%)
24	16.8	2.4	36	1440 x (1±10%)
48 ²⁾	33.6	4.8	72	5760 x (1±15%)
60 ²⁾	42.0	6.0	90	7500 x (1±15%)
110 ²⁾	77.0	11.0	165	25200 x (1±15%)

- Notes:**1) Maximum voltage refers to the maximum voltage which relay coil could endure in a short period of time.
2) For products with rated voltage ≥ 48V, measures should be taken to prevent coil overvoltage in order to protect coil in test and application (eg. Connect diodes in parallel).

SAFETY APPROVAL RATINGS

VDE	16A 250VAC at 85°C
UL/CUL	16A 250VAC at 85°C Incandescent lamp 3000W 230VAC TV-8 120VAC Incandescent lamp 1200W 120VAC at 50°C Incandescent lamp 1200W 277VAC at 50°C Standard ballast 2.2A 277VAC at 50°C Electronic ballast 16A 277/120VAC 85°C Electronic ballast 12A 277/120VAC 85°C Electronic ballast 8A 277/347VAC 85°C Electronic ballast 15A 120VAC 85°C Electronic ballast 8A 277/347VAC 85°C

- Notes:** 1) All values unspecified are at room temperature.
2) Only typical loads are listed above. Other load specifications can be available upon request.
3) Zero crossing control cooperative.



HONGFA RELAY

ISO9001, ISO/TS16949, ISO14001, OHSAS18001, IECQ QC 080000 CERTIFIED

ORDERING INFORMATION

Type	HF115F-S /		12	-H	S	F	(XXX)
Coil voltage	5, 6, 9, 12, 18, 24, 48, 60, 110VDC						
Contact arrangement	H: 1 Form A						
Construction ^{1) 2)}	S: Plastic sealed		Nil: Flux proofed				
Insulation Standard	F: Class F		Nil: Class B				
Special code ³⁾	XXX: Customer special requirement			Nil: Standard			

- Notes:** 1) We recommend flux proofed types for a clean environment (free from contaminations like H₂S, SO₂, NO₂, dust, etc.). We suggest to choose plastic sealed types and validate it in real application for an unclean environment (with contaminations like H₂S, SO₂, NO₂, dust, etc.).
- 2) Contact is recommended for suitable condition and specifications if water cleaning or surface process is involved in assembling relays on PCB.
- 3) The customer special requirement express as special code after evaluating by Hongfa. e.g.(335) stands for product in accordance to IEC 60335-1 (GWT).

OUTLINE DIMENSIONS, WIRING DIAGRAM AND PC BOARD LAYOUT

Unit: mm

Outline Dimensions

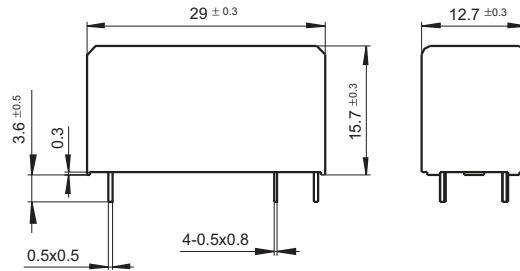

PCB Layout (Bottom view)

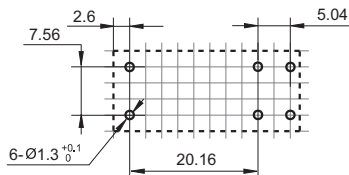

Wiring Diagram (Bottom view)



- Remark:** 1) In case of no tolerance shown in outline dimension: outline dimension ≤ 1 mm, tolerance should be ± 0.2 mm; outline dimension > 1 mm and ≤ 5 mm, tolerance should be ± 0.3 mm; outline dimension > 5 mm, tolerance should be ± 0.4 mm.
- 2) The tolerance without indicating for PCB layout is always ± 0.1 mm.
- 3) The width of the gridding is 2.52mm.

Disclaimer

The specification is for reference only. See to "Terminology and Guidelines" for more information. Specifications subject to change without notice. We could not evaluate all the performance and all the parameters for every possible application. Thus the user should be in a right position to choose the suitable product for their own application. If there is any query, please contact Hongfa for the technical service. However, it is the user's responsibility to determine which product should be used only.

HF115F-L 1 pole

MINIATURE HIGH POWER LATCHING RELAY



File No.:E134517



File No.:116934



File No.:CQC14002104529



Features

- Latching relay
- Low height: 15.7 mm
- 20A switching capability
- 5kV dielectric strength
(between coil and contacts)
- Creepage distance: 11mm-NO/10mm-CO version
- Meeting VDE 0700, 0631 reinforce insulation
- Product in accordance to IEC 60335-1 available
- UL insulation system: Class F
- Environmental friendly product (RoHS compliant)
- Outline Dimensions: (29.0 x 12.7 x 15.7) mm

CONTACT DATA

Contact arrangement	1A, 1C
Contact resistance	100mΩ max.(at 1A 6VDC)
Contact material	AgSnO ₂
Contact rating (Res. load)	16A 250VAC
Typ. applicable load	Incandescent lamp:1500W 277VAC Standard ballast:8A 277VAC Electronic ballast: 5A 120VAC
Max. switching voltage	440VAC / 300VDC
Max. switching current	20A
Max. switching power	4000VA
Mechanical endurance	2 x 10 ⁶ OPS
Electrical endurance	5 x 10 ⁴ OPS (NO: 16A 250VAC, Resistive load, at 85°C, 1s on 9s off)

CHARACTERISTICS

Insulation resistance	1000MΩ (at 500VDC)
Dielectric strength	Between coil & contacts 5000VAC 1min
	Between open contacts 1000VAC 1min
Surge voltage (between coil & contacts)	10kV (1.2 / 50μs)
Set time (at nomi. volt.)	10ms max.
Reset time (at nomi. volt.)	10ms max.
Shock resistance *	Functional 98m/s ²
	Destructive 980m/s ²
Vibration resistance *	10Hz to 150Hz 10g/5g
Humidity	5% to 85% RH
Ambient temperature	-40°C to 85°C
Termination	PCB
Unit weight	Approx. 13.5g
Construction	Plastic sealed, Flux proofed

Notes: 1) The data shown above are initial values.
2) * Index is not in relay length direction.

COIL

Coil power	1 coil latching: Approx. 400mW 2 coils latching: Approx. 600mW
------------	---

COIL DATA

at 23°C

1 coil latching

Nominal Voltage VDC	Set Voltage VDC max.	Pulse Width (ms)		Reset Voltage VDC max.	Max. Voltage VDC	Coil Resistance Ω
		Typical	Min.			
5	3.5	≥50	30	3.5	6	62x (1±10%)
6	4.2	≥50	30	4.2	7.2	90x (1±10%)
9	6.3	≥50	30	6.3	10.8	202x (1±10%)
12	8.4	≥50	30	8.4	14.4	360x (1±10%)
24	16.8	≥50	30	16.8	28.8	1440x (1±10%)

2 coils latching

Nominal Voltage VDC	Set Voltage VDC max.	Pulse Width (ms)		Reset Voltage VDC max.	Max. Voltage VDC	Coil Resistance Ω
		Typical	Min.			
5	3.5	≥50	30	3.5	7.5	42x (1±10%)
6	4.2	≥50	30	4.2	9	55x (1±10%)
9	6.3	≥50	30	6.3	13.5	135x (1±10%)
12	8.4	≥50	30	8.4	18	240x (1±10%)
24	16.8	≥50	30	16.8	36	886x (1±10%)

SAFETY APPROVAL RATINGS

UL/CUL	16A/20A 250VAC at 85°C 1HP 240VAC TV-5 120VAC(1 Form A) Tungsten 360W 125VAC(1 Form A) Tungsten 1920W 8A 240VAC at 40°C Tungsten 960W 8A 120VAC at 40°C Standard ballast 16A 120VAC Standard ballast 8A 277VAC Standard ballast 5A 347VAC/480VAC Electronic ballast 5A 120VAC TV-8 240VAC
	16A 250VAC at 85°C AC-15 250VAC at 85°C
VDE	16A 250VAC at 85°C AC-15 250VAC at 85°C

Notes: 1) All values unspecified are at room temperature.
2) Only typical loads are listed above. Other load specifications can be available upon request.



HONGFA RELAY

ISO9001, ISO/TS16949, ISO14001, OHSAS18001, IECQ QC 080000 CERTIFIED

ORDERING INFORMATION

Type	HF115F-L / 12 -Z S 3 L1 T G F (XXX)
Coil voltage	5, 6, 9, 12, 24VDC
Contact arrangement	H: 1 Form A Z: 1 Form C
Construction ^{1) 2)}	S: Plastic sealed Nil: Flux proofed
Version	3: 5.0mm 1 pole 16A
Sort	L1: 1 coil latching L2: 2 coils latching
Contact material	T: AgSnO ₂
Contact plating ³⁾	G: Gold plated Nil: No gold plated
Insulation standard	F: Class F
Special code ⁴⁾	XXX: Customer special requirement Nil: Standard

- Notes:** 1) We recommend flux proofed types for a clean environment (free from contaminations like H₂S, SO₂, NO₂, dust, etc.). We suggest to choose plastic sealed types and validate it in real application for an unclean environment (with contaminations like H₂S, SO₂, NO₂, dust, etc).
- 2) Contact is recommended for suitable condition and specifications if water cleaning or surface process is involved in assembling relays on PCB.
- 3) For gold plated type, the min. switching current and min. switching voltage is 10mA 5VDC.
- 4) The customer special requirement express as special code after evaluating by Hongfa. e.g.(335) stands for product in accordance to IEC 60335-1 (GWT).

OUTLINE DIMENSIONS, WIRING DIAGRAM AND PC BOARD LAYOUT

Unit: mm

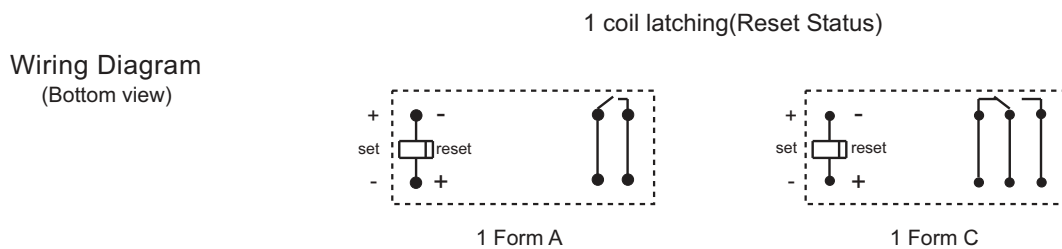
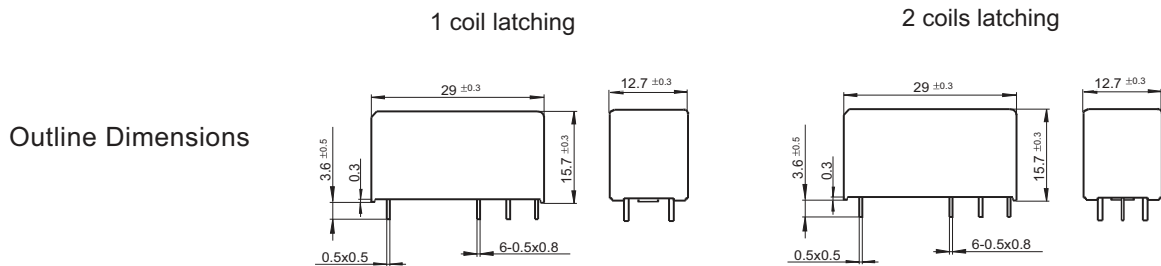

2 coils latching(Reset Status)

Wiring Diagram
(Bottom view)

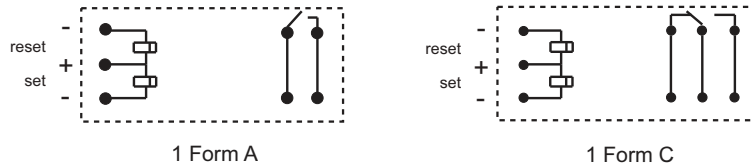

PCB Layout
(Bottom view)

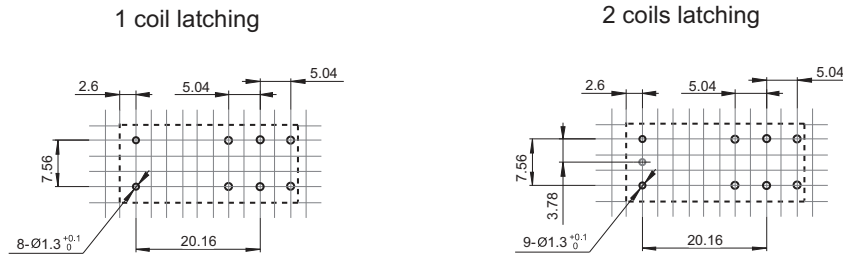

- Remark: 1) In case of no tolerance shown in outline dimension: outline dimension $\leq 1\text{mm}$, tolerance should be $\pm 0.2\text{mm}$; outline dimension $> 1\text{mm}$ and $\leq 5\text{mm}$, tolerance should be $\pm 0.3\text{mm}$; outline dimension $> 5\text{mm}$, tolerance should be $\pm 0.4\text{mm}$.
 2) The tolerance without indicating for PCB layout is always $\pm 0.1\text{mm}$.
 3) The width of the gridding is 2.52mm .

Notice

1. Relay is on the "reset" or "set" status when being released from stock, with the consideration of shock risen from transit and relay mounting, relay would be changed to "set" or "reset" status, therefore, when application (connecting the power supply), please reset the relay to "set" or "reset" status on request.
2. In order to maintain "set" or "reset" status, energized voltage to coil should reach the rated voltage. Do not energize voltage to "set" coil and "reset" coil simultaneously. And also long energized time (more than 1 min) should be avoided.
3. Keep the product away from strong magnetic field during transportation, storage and application, to avoid change of set/reset voltage.

Disclaimer

The specification is for reference only. See to "Terminology and Guidelines" for more information. Specifications subject to change without notice. We could not evaluate all the performance and all the parameters for every possible application. Thus the user should be in a right position to choose the suitable product for their own application. If there is any query, please contact Hongfa for the technical service. However, it is the user's responsibility to determine which product should be used only.

© Xiamen Hongfa Electroacoustic Co., Ltd. All rights of Hongfa are reserved.

HF115F-L 2 pole

MINIATURE HIGH POWER LATCHING RELAY



File No.:E134517



File No.:116934



File No.:CQC14002104529



Features

- Latching relay
- Low height: 15.7 mm
- 8A switching capability
- 5kV dielectric strength (between coil and contacts)
- Creepage distance: 11mm-NO/10mm-CO version
- Meeting VDE 0700, 0631 reinforce insulation
- Product in accordance to IEC 60335-1 available
- UL insulation system: Class F
- Environmental friendly product (RoHS compliant)
- Outline Dimensions: (29.0 x 12.7 x 15.7) mm

CONTACT DATA

Contact arrangement	2A, 2C
Contact resistance	100mΩ max.(at 1A 6VDC)
Contact material	AgSnO ₂
Contact rating(Res. load)	8A 250VAC
Typ. applicable load	Lamp: Tungsten 3A 277VAC Standard ballast: 3A 277VAC
Max. switching voltage	440VAC / 300VDC
Max. switching current	8A
Max. switching power	2000VA
Mechanical endurance	2 x 10 ⁶ OPS
Electrical endurance	2H type: 5 x 10 ⁴ OPS (8A 277VAC, General use, at 85°C, 5s on 5s off) 2Z type: 1 x 10 ⁴ OPS (8A 277VAC, General use, at 85°C, 5s on 5s off)

CHARACTERISTICS

Insulation resistance	1000MΩ (at 500VDC)	
Dielectric strength	Between coil & contacts	5000VAC 1min
	Between open contacts	1000VAC 1min
	Between contact sets	2500VAC 1min
Surge voltage (between coil & contacts)	10kV (1.2 / 50μs)	
Set time (at nomi. volt.)	10ms max.	
Reset time (at nomi. volt.)	10ms max.	
Shock resistance *	Functional	98m/s ²
	Destructive	980m/s ²
Vibration resistance *	10Hz to 150Hz 10g/5g	
Humidity	5% to 85% RH	
Ambient temperature	-40°C to 85°C	
Termination	PCB	
Unit weight	Approx. 13.5g	
Construction	Plastic sealed, Flux proofed	

Notes: 1) The data shown above are initial values.
2) * Index is not in relay length direction.

COIL

Coil power	1 coil latching: Approx. 400mW 2 coils latching: Approx. 600mW
------------	---

COIL DATA

at 23°C

1 coil latching

Nominal Voltage VDC	Set Voltage VDC max.	Pulse Width (ms)		Reset Voltage VDC max.	Max. Voltage VDC	Coil Resistance Ω
		Typical	Min.			
5	3.5	≥50	30	3.5	6	62x (1±10%)
6	4.2	≥50	30	4.2	7.2	90x (1±10%)
9	6.3	≥50	30	6.3	10.8	202x (1±10%)
12	8.4	≥50	30	8.4	14.4	360x (1±10%)
24	16.8	≥50	30	16.8	28.8	1440x (1±10%)

2 coils latching

Nominal Voltage VDC	Set Voltage VDC max.	Pulse Width (ms)		Reset Voltage VDC max.	Max. Voltage VDC	Coil Resistance Ω
		Typical	Min.			
5	3.5	≥50	30	3.5	7.5	42x (1±10%)
6	4.2	≥50	30	4.2	9	55x (1±10%)
9	6.3	≥50	30	6.3	13.5	135x (1±10%)
12	8.4	≥50	30	8.4	18	240x (1±10%)
24	16.8	≥50	30	16.8	36	886x (1±10%)

SAFETY APPROVAL RATINGS

UL/CUL	10A/8A 277VAC General use at 85°C 1/2 HP 240VAC at 40°C Standard ballast 3A 277VAC at 40°C Tungsten Lamp 3A 277VAC at 40°C
VDE	8A 277VAC at 85°C

Notes: 1) All values unspecified are at room temperature.
2) Only typical loads are listed above. Other load specifications can be available upon request.



HONGFA RELAY

ISO9001, ISO/TS16949, ISO14001, OHSAS18001, IECQ QC 080000 CERTIFIED

ORDERING INFORMATION

Type	HF115F-L / 12 -2Z S 4 L1 T G F (XXX)								
Coil voltage	5, 6, 9, 12, 24VDC								
Contact arrangement	2H: 2 Form A 2Z: 2 Form C								
Construction ¹⁾²⁾	S: Plastic sealed Nil: Flux proofed								
Version	4: 5.0mm 2 pole 8A								
Sort	L1: 1 coil latching L2: 2 coils latching								
Contact material	T: AgSnO ₂								
Contact plating ³⁾	G: Gold plated				Nil: No gold plated				
Insulation standard	F: Class F								
Special code ⁴⁾	XXX: Customer special requirement				Nil: Standard				

- Notes:** 1) We recommend flux proofed types for a clean environment (free from contaminations like H₂S, SO₂, NO₂, dust, etc.). We suggest to choose plastic sealed types and validate it in real application for an unclear environment (with contaminations like H₂S, SO₂, NO₂, dust, etc.).
- 2) Contact is recommended for suitable condition and specifications if water cleaning or surface process is involved in assembling relays on PCB.
- 3) For gold plated type, the min. switching current and min. switching voltage is 10mA 5VDC.
- 4) The customer special requirement express as special code after evaluating by Hongfa. e.g. (335) stands for product in accordance to IEC 60335-1 (GWT).

OUTLINE DIMENSIONS, WIRING DIAGRAM AND PC BOARD LAYOUT

Unit: mm

Outline Dimensions

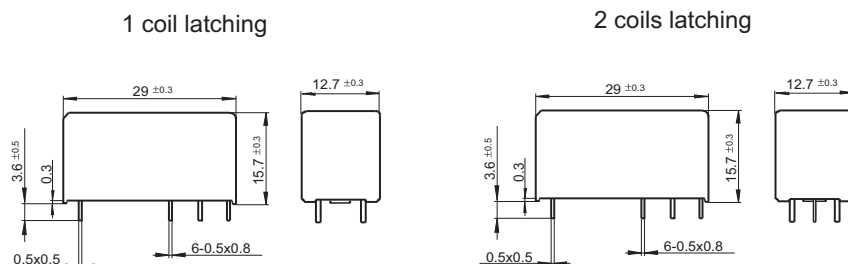

Wiring Diagram (Bottom view)

1 coil latching(Reset Status)



Wiring Diagram
(Bottom view)

2 coils latching(Reset Status)

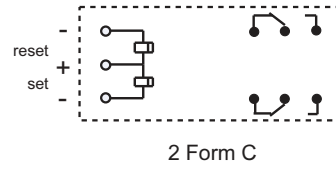
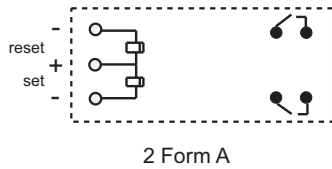

PCB Layout
(Bottom view)

1 coil latching

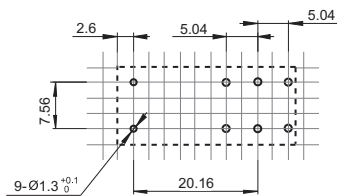

2 coils latching

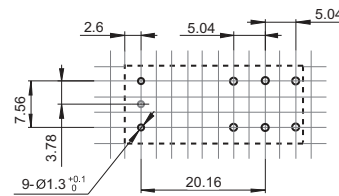

- Remark: 1) In case of no tolerance shown in outline dimension: outline dimension $\leq 1\text{mm}$, tolerance should be $\pm 0.2\text{mm}$; outline dimension $> 1\text{mm}$ and $\leq 5\text{mm}$, tolerance should be $\pm 0.3\text{mm}$; outline dimension $> 5\text{mm}$, tolerance should be $\pm 0.4\text{mm}$.
 2) The tolerance without indicating for PCB layout is always $\pm 0.1\text{mm}$.
 3) The width of the gridding is 2.52mm.

Notice

1. Relay is on the "reset" or "set" status when being released from stock, with the consideration of shock risen from transit and relay mounting, relay would be changed to "set" or "reset" status, therefore, when application (connecting the power supply), please reset the relay to "set" or "reset" status on request.
2. In order to maintain "set" or "reset" status, energized voltage to coil should reach the rated voltage. Do not energize voltage to "set" coil and "reset" coil simultaneously. And also long energized time (more than 1 min) should be avoided.
3. Keep the product away from strong magnetic field during transportation, storage and application, to avoid change of set/reset voltage.

Disclaimer

The specification is for reference only. See to "Terminology and Guidelines" for more information. Specifications subject to change without notice. We could not evaluate all the performance and all the parameters for every possible application. Thus the user should be in a right position to choose the suitable product for their own application. If there is any query, please contact Hongfa for the technical service. However, it is the user's responsibility to determine which product should be used only.

HF115F-LS

MINIATURE HIGH POWER LATCHING RELAY



File No.:E134517



File No.:116934



File No.:CQC14002104529



Features

- Latching relay
- Special contact struction
- Incandescent lamp load: 3500W 277VAC
- 5kV dielectric strength (between coil and contacts)
- Creepage distance: 11mm
- Low height: 15.7 mm
- Meeting reinforce insulation
- Product in accordance to EN60669-1 available
- Product in accordance to IEC 60335-1 available
- Plastic sealed and flux proofed types available
- UL insulation system: Class F
- Environmental friendly product (RoHS compliant)
- Outline Dimensions: (29.0 x 12.7 x 15.7) mm

CONTACT DATA

Contact arrangement	1A
Contact resistance	100mΩ max.(at 1A 6VDC)
Contact material	W+AgSnO ₂
Contact rating	Resistive:16A 250VAC
	Incandescent Lamp: 3500W 277VAC
	Inrush current: 165A / 20ms flourescent: 800A/200μs
Max. switching voltage	440VAC
Max. switching current	16A
Max. switching power	4000VA
Mechanical endurance	2 x 10 ⁶ OPS
Electrical endurance	1.2 x 10 ⁴ OPS (3500W 277VAC, Tungsten lamp, at 40°C, 1s on 59s off) 6 x 10 ³ OPS(16A 250VAC, Resistive load, at 85°C, 5s on 5s off)

CHARACTERISTICS

Insulation resistance	1000MΩ (at 500VDC)	
Dielectric strength	Between coil & contacts	5000VAC 1min
	Between open contacts	1250VAC 1min
Surge voltage (between coil & contacts)	10kV (1.2 / 50μs)	
Set time (at nomi. volt.)	10ms max.	
Reset time (at nomi. volt.)	10ms max.	
Temperature rise (at nomi. volt.)	55K max.	
Shock resistance *	Functional	98m/s ²
	Destructive	980m/s ²
Vibration resistance *	10Hz to 150Hz	10g
Humidity	5% to 85% RH	
Ambient temperature	-40°C to 85°C	
Termination	PCB	
Unit weight	Approx. 13.5g	
Construction	Plastic sealed, Flux proofed	

Notes:1) This contact resistance value is tested under the normal voltage.

- * Index is not that of relay length direction.
- The data shown above are initial values.
- UL insulation system: Class F.

COIL

Coil power	1 coil latching: Approx. 400mW 2 coils latching: Approx. 600mW
------------	---

COIL DATA

at 23°C

1 coil latching

Nominal Voltage VDC	Set Voltage VDC max.	Pulse Width (ms)		Reset Voltage VDC max.	Max. Voltage VDC	Coil Resistance Ω
		Typical	Min.			
5	3.5	≥50	30	3.5	6	62x (1±10%)
6	4.2	≥50	30	4.2	7.2	90x (1±10%)
9	6.3	≥50	30	6.3	10.8	202x (1±10%)
12	8.4	≥50	30	8.4	14.4	360x (1±10%)
24	16.8	≥50	30	16.8	28.8	1440x (1±10%)

2 coils latching

Nominal Voltage VDC	Set Voltage VDC max.	Pulse Width (ms)		Reset Voltage VDC max.	Max. Voltage VDC	Coil Resistance x (1±10%)Ω
		Typical	Min.			
5	3.5	≥50	30	3.5	7.5	42x (1±10%)
6	4.2	≥50	30	4.2	9	55x (1±10%)
9	6.3	≥50	30	6.3	13.5	135x (1±10%)
12	8.4	≥50	30	8.4	18	240x (1±10%)
24	16.8	≥50	30	16.8	36	886x (1±10%)

SAFETY APPROVAL RATINGS

UL/CUL	16A 250VAC General use at 85°C Standard ballast 5A 277VAC at 40°C Electronic ballast 16A 120VAC at 40°C Electronic ballast 16A 277VAC at 40°C 3500W 277VAC Tungsten Lamp at 40°C
VDE	16A 250VAC Resistive at 85°C EN60669: 16A 250VAC COSØ =0.6 16A 250VAC 140μF

Notes: 1) All values unspecified are at room temperature.

2) Only typical loads are listed above. Other load specifications can be available upon request.



HONGFA RELAY

ISO9001, ISO/TS16949, ISO14001, OHSAS18001, IECQ QC 080000 CERTIFIED

ORDERING INFORMATION

Type		HF115F-LS / 12		-H	S	L1	F	(XXX)
Coil voltage		5, 6, 9, 12, 24VDC						
Contact arrangement		H: 1 Form A						
Construction ¹⁾²⁾		S: Plastic sealed		Nil: Flux proofed				
Sort		L1: 1 coil latching		L2: 2 coils latching				
Insulation Standard		F: Class F						
Special code ³⁾		XXX: Customer special requirement			Nil: Standard			

- Notes:** 1) We recommend flux proofed types for a clean environment (free from contaminations like H₂S, SO₂, NO₂, dust, etc.). We suggest to choose plastic sealed types and validate it in real application for an unclear environment (with contaminations like H₂S, SO₂, NO₂, dust, etc.).
- 2) Contact is recommended for suitable condition and specifications if water cleaning or surface process is involved in assembling relays on PCB.
- 3) The customer special requirement express as special code after evaluating by Hongfa. e.g. (335) stands for product in accordance to IEC 60335-1 (GWT).

OUTLINE DIMENSIONS, WIRING DIAGRAM AND PC BOARD LAYOUT

Unit: mm

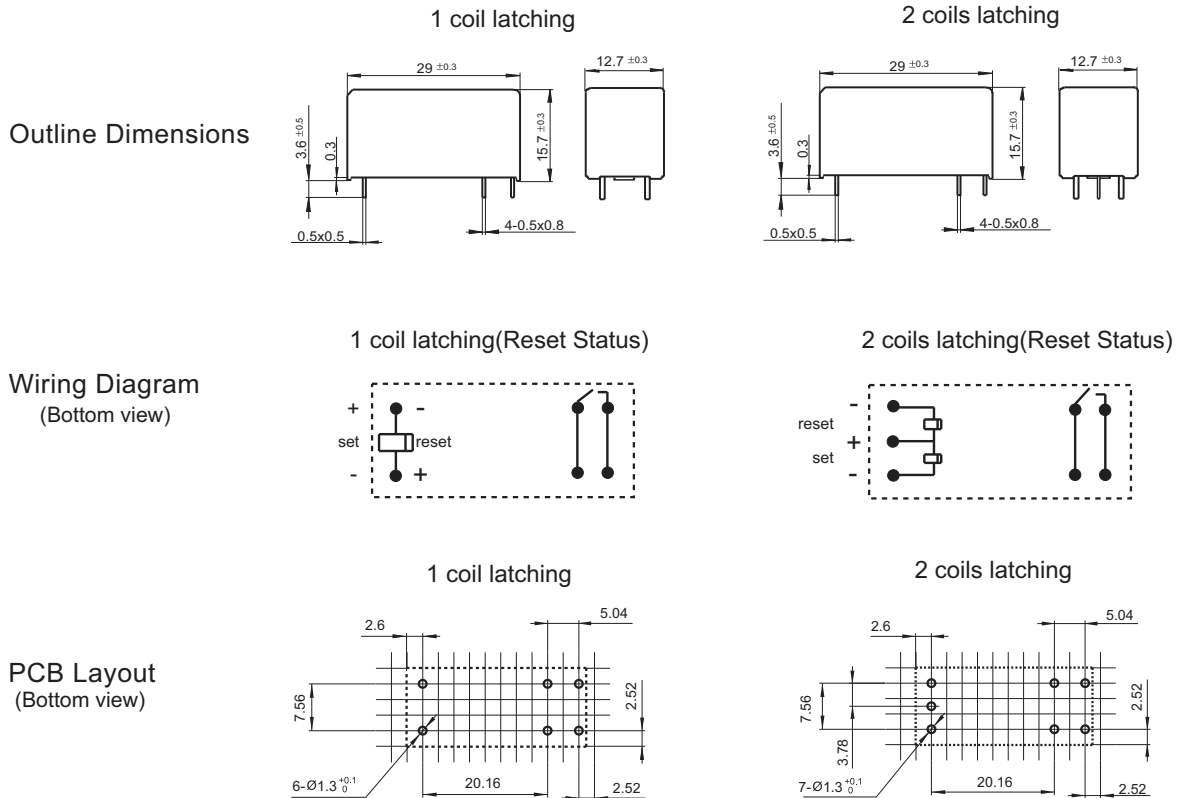

- Remark: 1) In case of no tolerance shown in outline dimension: outline dimension ≤ 1 mm, tolerance should be ± 0.2 mm; outline dimension > 1 mm and ≤ 5 mm, tolerance should be ± 0.3 mm; outline dimension > 5 mm, tolerance should be ± 0.4 mm.
- 2) The tolerance without indicating for PCB layout is always ± 0.1 mm.
- 3) The width of the gridding is 2.52mm.

Notice

1. Relay is on the "reset" or "set" status when being released from stock, with the consideration of shock risen from transit and relay mounting, relay would be changed to "set" or "reset" status, therefore, when application (connecting the power supply), please reset the relay to "set" or "reset" status on request.
2. In order to maintain "set" or "reset" status, energized voltage to coil should reach the rated voltage. Do not energize voltage to "set" coil and "reset" coil simultaneously. And also long energized time (more than 1 min) should be avoided.
3. Keep the product away from strong magnetic field during transportation, storage and application, to avoid change of set/reset voltage.

Disclaimer

The specification is for reference only. See to "Terminology and Guidelines" for more information. Specifications subject to change without notice. We could not evaluate all the performance and all the parameters for every possible application. Thus the user should be in a right position to choose the suitable product for their own application. If there is any query, please contact Hongfa for the technical service. However, it is the user's responsibility to determine which product should be used only.

© Xiamen Hongfa Electroacoustic Co., Ltd. All rights of Hongfa are reserved.

HF115FP

MINIATURE POWER RELAY



File No.: E133481



File No.: 116934



Features

- 1 pole 16A, 2 pole 8A , 1 CO & 2 CO contacts
- 5kV dielectric, Creepage distance 8 mm (coil to contacts)
- Meeting VDE 0700, 0631 reinforce insulation
- DC/AC coil type relay , Coil power 400mW / 0.75VA
- Manual test device
- Type with mechanical indicator / electrical indicator
- Sockets available
- Environmental friendly product (RoHS compliant)
- Outline Dimensions: (29.0 x 13.0 x 25.5) mm

CONTACT DATA

Contact arrangement	1C	2C
Contact resistance	100mΩ max.(at 1A 6VDC)	
Contact material	AgNi	
Contact rating (Res. load)	16A 250VAC	8A 250VAC
Max. switching voltage	440VAC	
Max. switching current	16A	8A
Max. switching power	4000VA	2000VA
Mechanical endurance	DC type: 5 x 10 ⁶ OPS AC type: 1 x 10 ⁶ OPS	
Electrical endurance	1Z3B type: 3x 10 ⁴ OPS (NO: 16A 250VAC, Resistive load, at 70°C, 1s on 9s off) 2Z4B type: 5 x 10 ⁴ OPS (NO: 8A 250VAC, Resistive load, at 70°C, 1s on 9s off)	

CHARACTERISTICS

Insulation resistance	1000MΩ (at 500VDC)	
Dielectric strength	Between coil & contacts	5000VAC 1min
	Between open contacts	1000VAC 1min
	Between contact sets	2500VAC 1min
Operate time (at nomi. volt.)	DC type: 15ms max.	
Release time (at nomi. volt.)	DC type: 8ms max.	
Temperature rise (at nomi. volt.)	DC type: 60K max. AC type: 85K max.	
Shock resistance*	Functiona	98m/s ²
	Destructive	980m/s ²
Vibration resistance*	NO	10Hz to 150Hz 10g
	NC	length direction: 10Hz to 150Hz 2g other direction: 10Hz to 150Hz 5g
Humidity	5% to 85% RH	
Ambient temperature	-40°C to 70°C	
Termination	PCB	
Unit weight	Approx. 16g	
Mounting distance	5mm, packing of sockets	

- Notes:** 1) The data shown above are initial values.
2) * Index is not that of relay length direction.
3) UL insulation system: Class A

COIL

Coil power	DC type: Approx. 400mW; AC type: Approx. 0.75VA
------------	--

Notes: The data shown above don't include the power of electronic indicating circuit when the relay picks-up.

COIL DATA

at 23°C

DC type

Nominal Voltage VDC	Pick-up Voltage VDC max.	Drop-out Voltage VDC min.	Max. Voltage VDC 1)	Coil Resistance Ω
12	8.4	1.2	18	360 x (1±10%)
24	16.8	2.4	36	1440 x (1±10%)
48 ²⁾	33.6	4.8	72	5760 x (1±15%)
110 ²⁾	77.0	11.0	165	25200 x (1±15%)

- Notes:** 1) Maximum voltage refers to the maximum voltage which relay coil could endure in a short period of time.
2) For products with rated voltage ≥ 48V, measures should be taken to prevent coil overvoltage in order to protect coil in test and application (eg. Connect diodes in parallel).

AC type(50Hz)

Nominal Voltage VAC	Pick-up Voltage VAC max.	Drop-out Voltage VAC min.	Coil Current mA	Coil DC Resistance Ω
24	18.0	3.6	31.6	350 x (1±10%)
115	86.3	17.25	6.6	8100 x (1±15%)
230	172.5	34.5	3.2	32500 x (1±15%)

SAFETY APPROVAL RATINGS

UL/CUL	1 Form C	16A 250VAC at 70°C
	2 Form C	8A 250VAC at 70°C
VDE	1 Form C	16A 250VAC at 70°C
	2 Form C	8A 250VAC at 70°C

- Notes:** 1) All values unspecified are at room temperature.
2) Only typical loads are listed above. Other load specifications can be available upon request.



HONGFA RELAY

ISO9001、ISO/TS16949、ISO14001、OHSAS18001、IECQ QC 080000 CERTIFIED

ORDERING INFORMATION

Type	HF115FP /	024	-1Z	3	B	(XXX)
Coil voltage	012 to 110: 12, 24, 48, 110 VDC A24 to A230: 24, 115, 230 VAC					
Contact arrangement	1Z: 1 Form C		2Z: 2 Form C			
Version	3: 5.0mm 1 pole 16A		4: 5.0mm 2 pole 8A			
Contact material	B: AgNi					
Special code ²⁾	XXX: Customer special requirement		Nil: Standard			

Notes: 1) Flux-proofed relays can not be used in the environment with pollutants like H₂S, SO₂, NO₂, dust, etc.
2) The customer special requirement express as special code after evaluating by Hongfa.

OUTLINE DIMENSIONS, WIRING DIAGRAM AND PC BOARD LAYOUT

Unit: mm

Outline Dimensions

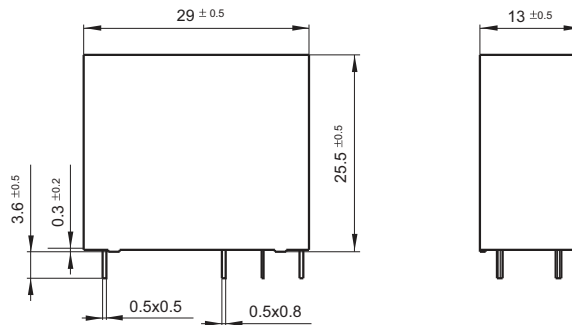

PCB Layout (Bottom view)

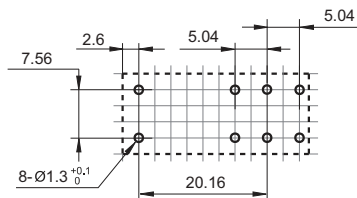

DIN rail Socket



Solder Socket



Remark: 1) In case of no tolerance shown in outline dimension: outline dimension ≤ 1 mm, tolerance should be ± 0.2 mm; outline dimension > 1 mm and ≤ 5 mm, tolerance should be ± 0.3 mm; outline dimension > 5 mm, tolerance should be ± 0.4 mm.
2) The tolerance without indicating for PCB layout is always ± 0.1 mm.
3) The width of the gridding is 2.52mm.

OUTLINE DIMENSIONS, WIRING DIAGRAM AND PC BOARD LAYOUT

Unit: mm

Wiring Diagram (Bottom view)

HF115FP/ □□□ -1Z3□

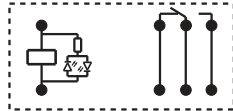

HF115FP/ □□□ -2Z4□

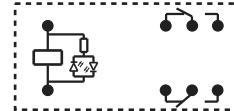

HF115FP/A □□□ -1Z3□

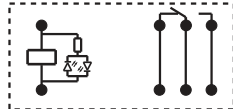

HF115FP/A □□□ -2Z4□

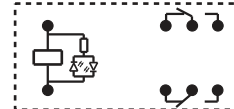

Remark: DC coil with a parallel diode is available but the coil terminal is different in positive or cathode.

CHARACTERISTIC CURVES

MAXIMUM SWITCHING POWER

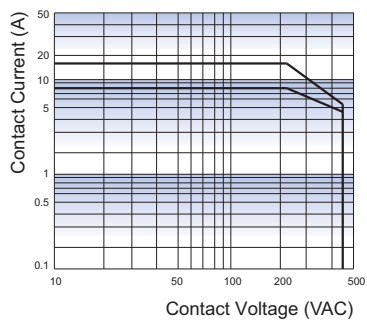

ENDURANCE CURVE

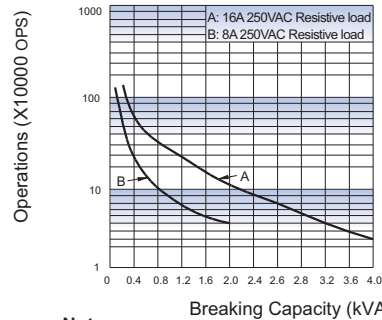

Notes:

- 1. Curve A: 1Z3B type
Curve B: 2Z4B type
- 2. Test conditions:
NO, Flux proofed, Room temp., 1s on 9s off

COIL OPERATING RANGE (AC) *

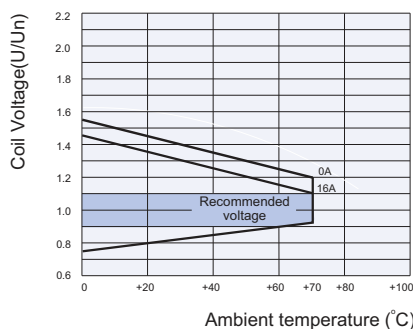

COIL OPERATING RANGE (DC) *

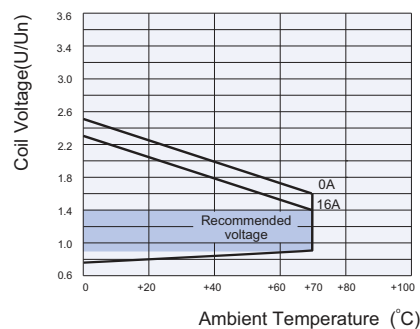

Notes: * The use of a relay with an energising voltage other than the rated coil voltage may lead to reduced electrical life. An energising voltage over the abver range may damage the insulation of relay coil.

Disclaimer

The specification is for reference only. See to "Terminology and Guidelines" for more information. Specifications subject to change without notice. We could not evaluate all the performance and all the parameters for every possible application. Thus the user should be in a right position to choose the suitable product for their own application. If there is any query, please contact Hongfa for the technical service. However, it is the user's responsibility to determine which product should be used only.

HF115FK

MINIATURE HIGH POWER RELAY



File No.:E134517



File No.:116934



File No.:CQC13002103948



Features

- Low height: 15.7 mm
- 16A switching capability
- 5kV dielectric strength (between coil and contacts)
- Creepage distance: 10mm
- Meeting reinforce insulation
- Flux proofed type
- Product in accordance to IEC 60335-1 available
- UL insulation system: Class F
- Environmental friendly product (RoHS compliant)
- Outline Dimensions: (29.0 x 12.7 x 15.7) mm

CONTACT DATA

Contact arrangement	1A, 1C	2A, 2C
Contact resistance	100mΩ max.(at 1A 6VDC)	
Contact material	AgSnO ₂	
Contact rating (Res. load)	12A/16A 250VAC	8A 250VAC
Max. switching voltage	400VAC	
Max. switching current	12A / 16A	8A
Max. switching power	3000VA / 4000VA	2000VA
Mechanical endurance	1 x 10 ⁷ OPS	
Electrical endurance	H3T type: 1 x 10 ⁵ OPS (NO: 16A 277VAC, Resistive Load at 40°C, 1s on 9s off) Z3T type: 5 x 10 ⁴ OPS (NO: 16A 250VAC, Resistive Load, at 85°C, 1s on 9s off) 2Z4T type: 5 x 10 ⁴ OPS (NO: 8A 250VAC, Resistive Load, at 85°C, 1s on 9s off)	

COIL

Coil power	Approx. 400mW
------------	---------------

COIL DATA

at 23°C

Nominal Voltage VDC	Pick-up Voltage VDC max.	Drop-out Voltage VDC min.	Max. Voltage VDC *	Coil Resistance Ω
5	3.50	0.5	7.5	62 x (1±10%)
6	4.20	0.6	9.0	90 x (1±10%)
9	6.30	0.9	13.5	202 x (1±10%)
12	8.40	1.2	18	360 x (1±10%)
18	12.60	1.8	27	810 x (1±10%)
24	16.80	2.4	36	1440 x (1±10%)
48	33.60	4.8	72	5760 x (1±15%)

Notes: *Maximum voltage refers to the maximum voltage which relay coil could endure in a short period of time.

CHARACTERISTICS

Insulation resistance	1000MΩ (at 500VDC)	
Dielectric strength	Between coil & contacts	5000VAC 1min
	Between open contacts	1000VAC 1min
	Between contact sets	2500VAC 1min
Surge voltage (between coil & contacts)	10kV (1.2 x 50μs)	
Operate time (at nomi. volt.)	10ms max.	
Release time (at nomi. volt.)	5ms max.	
Shock resistance *	Functional	98m/s ²
	Destructive	980m/s ²
Vibration resistance *	10Hz to 150Hz 10g/5g	
Humidity	5% to 85% RH	
Ambient temperature	-40°C to 85°C	
Termination	PCB	
Unit weight	Approx. 13g	
Construction	Flux proofed	

Notes: 1) The data shown above are initial values.
2) * Index is not in relay length direction.

SAFETY APPROVAL RATINGS

UL/CUL	2Z4T: 8A 250VAC at 85°C
	Z1T: 12A 250VAC at 85°C
	Z2T: 12A 250VAC at 85°C
	Z3T: 16A 250VAC at 85°C
VDE	2Z4T: 8A 250VAC at 85°C
	Z1T: 12A 250VAC at 85°C
	Z2T: 12A 250VAC at 85°C
	Z3T: 16A 250VAC at 85°C

Notes: 1) All values unspecified are at room temperature.
2) Only typical loads are listed above. Other load specifications can be available upon request.



HONGFA RELAY

ISO9001, ISO/TS16949, ISO14001, OHSAS18001, IECQ QC 080000 CERTIFIED

ORDERING INFORMATION

Type	HF115FK /	12	-H	3	T	(XXX)
Coil voltage	5, 6, 9, 12, 18, 24, 48 VDC					
Contact arrangement	H: 1 Form A Z: 1 Form C 2H: 2 Form A 2Z: 2 Form C					
Version	1: 3.5mm 1 pole 12A 3: 5.0mm 1 pole 16A		2: 5.0mm 1 pole 12A 4: 5.0mm 2 pole 8A			
Contact material ¹⁾	T: AgSnO ₂					
Special code ³⁾	XXX: Customer special requirement		Nil: Standard			

- Notes:**
- 1) We recommend flux proofed types for a clean environment (free from contaminations like H₂S, SO₂, NO₂, dust, etc.).
 - 2) Contact is recommended for suitable condition and specifications if water cleaning or surface process is involved in assembling relays on PCB.
 - 3) The customer special requirement express as special code after evaluating by Hongfa. e.g.(335) stands for product in accordance to IEC 60335-1 (GWT).

OUTLINE DIMENSIONS, WIRING DIAGRAM AND PC BOARD LAYOUT

Unit: mm

Outline Dimensions

3.5mm Pinning (HF115FK/ □□□-1-□)

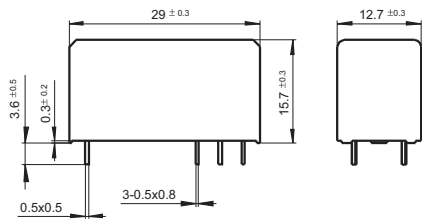

5mm Pinning (HF115FK/ □□□-□-2/3/4-□)

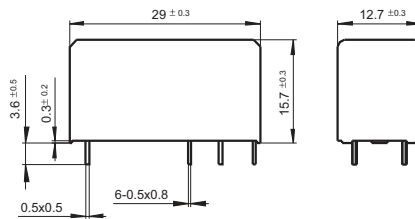

Wiring Diagram (Bottom view)

3.5/5mm Pinning, 1 Pole, 12A, HF115FK/ □□□-1/2-□



1 Form A

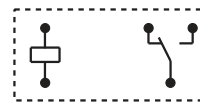

1 Form C

5mm Pinning, 1 Pole, 16A, HF115FK/ □□□-3-□



1 Form A

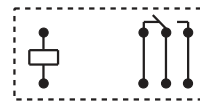

1 Form C

5mm Pinning, 2 Pole, 8A, HF115FK/ □□□-2□-4-□

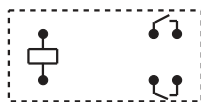

2 Form A

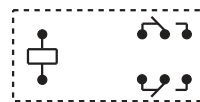

2 Form C

PCB Layout (Bottom view)

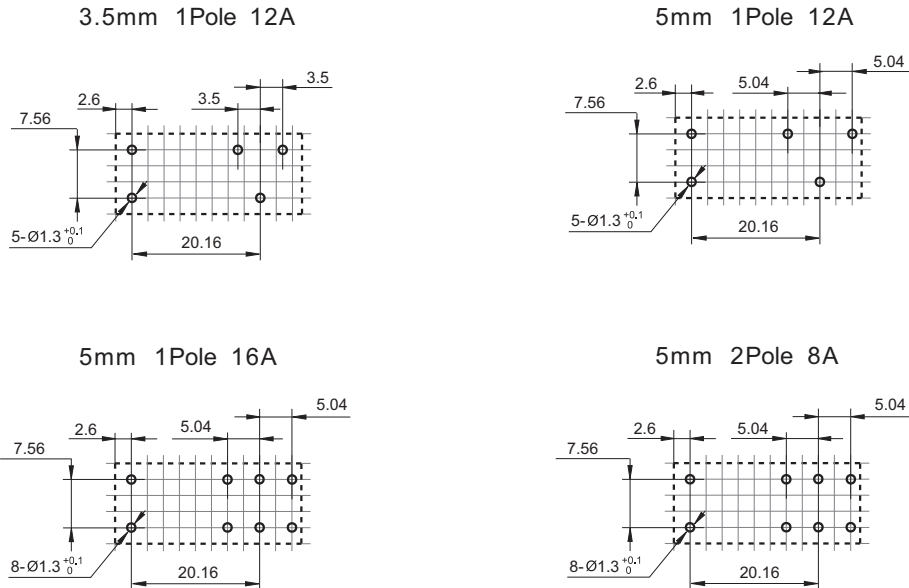

Remark: 1) In case of no tolerance shown in outline dimension: outline dimension $\leq 1\text{mm}$, tolerance should be $\pm 0.2\text{mm}$; outline dimension $> 1\text{mm}$ and $\leq 5\text{mm}$, tolerance should be $\pm 0.3\text{mm}$; outline dimension $> 5\text{mm}$, tolerance should be $\pm 0.4\text{mm}$.
 2) The tolerance without indicating for PCB layout is always $\pm 0.1\text{mm}$.
 3) The width of the gridding is 2.52mm.

CHARACTERISTIC CURVES

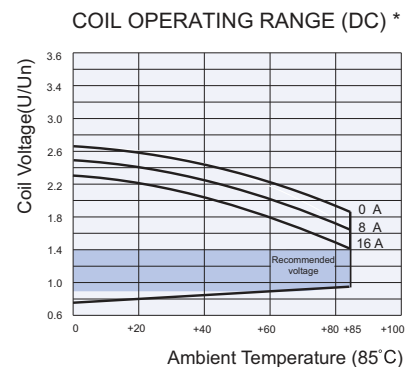
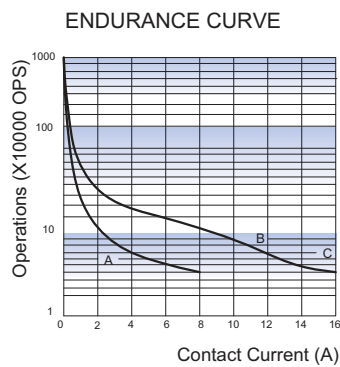
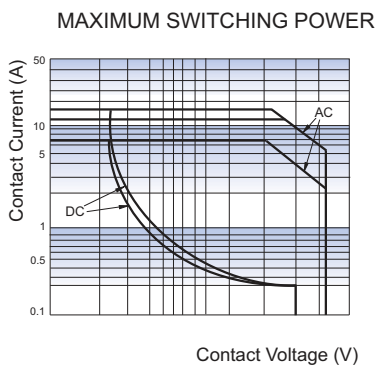

Test conditions:

- 1) Curve A: Z24T type
 Curve B: Z2T type (or Z2T type)
 Curve C: Z3T type
- 2) Test conditions:
 NO, resistive load, 250VAC, flux proofed,
 at 85°C, 1s on 9s off

Notes: * The use of a relay with an energising voltage other than the rated coil voltage may lead to reduced electrical life. An energising voltage over the above range may damage the insulation of relay coil.

Disclaimer

The specification is for reference only. See to 'Terminology and Guidelines' for more information. Specifications subject to change without notice. We could not evaluate all the performance and all the parameters for every possible application. Thus the user should be in a right position to choose the suitable product for their own application. If there is any query, please contact Hongfa for the technical service. However, it is the user's responsibility to determine which product should be used only.

© Xiamen Hongfa Electroacoustic Co., Ltd. All rights of Hongfa are reserved.

HF115FK-T

MINIATURE HIGH POWER RELAY



File No.:E134517



File No.:116934



File No.:CQC13002103948



Features

- High temperature: 105°C
- Low height: 15.7 mm
- 16A switching capability
- 5kV dielectric strength (between coil and contacts)
- Creepage distance: 10mm
- Meeting reinforce insulation
- Product in accordance to IEC 60335-1 available
- Sockets available
- UL insulation system: Class F
- Environmental friendly product (RoHS compliant)
- Outline Dimensions: (29.0 x 12.7 x 15.7) mm

CONTACT DATA

Contact arrangement	1A, 1C
Contact resistance	100mΩ max.(at 1A 6VDC)
Contact material	AgSnO ₂
Contact rating (Res. load)	16A 250VAC
Max. switching voltage	400VAC
Max. switching current	16A
Max. switching power	4000VA
Mechanical endurance	1 x 10 ⁷ OPS
Electrical endurance	H3T type: 3 x 10 ⁴ OPS (16A 250VAC, Resistive Load, at 105°C, 1s on 9s off)

CHARACTERISTICS

Insulation resistance	1000MΩ (at 500VDC)	
Dielectric strength	Between coil & contacts	5000VAC 1min
	Between open contacts	1000VAC 1min
Surge voltage (between coil & contacts)	10kV (1.2 x 50μs)	
Operate time (at nomi. volt.)	10ms max.	
Release time (at nomi. volt.)	5ms max.	
Shock resistance *	Functional	98m/s ²
	Destructive	980m/s ²
Vibration resistance *	10Hz to 150Hz 10g/5g	
Humidity	5% to 85% RH	
Ambient temperature	-40°C to 105°C	
Termination	PCB	
Unit weight	Approx. 13g	
Construction	Flux proofed	

Notes: 1) The data shown above are initial values.
2) * Index is not in relay length direction.

COIL

Coil power	Approx. 400mW
------------	---------------

COIL DATA

at 23°C

Nominal Voltage VDC	Pick-up Voltage VDC max.	Drop-out Voltage VDC min.	Max. Voltage VDC *	Coil Resistance Ω
5	3.50	0.5	7.5	62 x (1±10%)
6	4.20	0.6	9.0	90 x (1±10%)
9	6.30	0.9	13.5	202 x (1±10%)
12	8.40	1.2	18	360 x (1±10%)
18	12.60	1.8	27	810 x (1±10%)
24	16.80	2.4	36	1440 x (1±10%)
48	33.60	4.8	72	5760 x (1±15%)

Notes: *Maximum voltage refers to the maximum voltage which relay coil could endure in a short period of time.

SAFETY APPROVAL RATINGS

UL/CUL	16A 250VAC at 105°C
VDE	16A 250VAC at 105°C 10A 250VAC at 105°C

Notes: 1) All values unspecified are at room temperature.
2) Only typical loads are listed above. Other load specifications can be available upon request.



HONGFA RELAY

ISO9001, ISO/TS16949, ISO14001, OHSAS18001, IECQ QC 080000 CERTIFIED

ORDERING INFORMATION

Type	HF115FK-T/	12	-H	3	T	(XXX)
Coil voltage	5, 6, 9, 12, 18, 24, 48VDC					
Contact arrangement	H: 1 Form A Z: 1 Form C					
Version	3: 5.0mm 1 pole 16A					
Contact material ¹⁾	T: AgSnO ₂					
Special code ³⁾	XXX: Customer special requirement		Nil: Standard			

- Notes:** 1) We recommend flux proofed types for a clean environment (free from contaminations like H₂S, SO₂, NO₂, dust, etc.).
 2) Contact is recommended for suitable condition and specifications if water cleaning or surface process is involved in assembling relays on PCB.
 3) The customer special requirement express as special code after evaluating by Hongfa. e.g.(335) stands for product in accordance to IEC 60335-1 (GWT).

OUTLINE DIMENSIONS, WIRING DIAGRAM AND PC BOARD LAYOUT

Unit: mm

Outline Dimensions

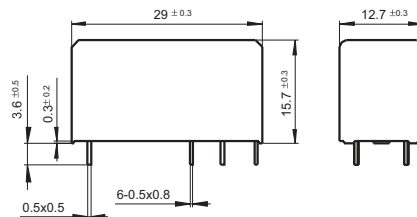

Wiring Diagram (Bottom view)



PCB Layout (Bottom view)

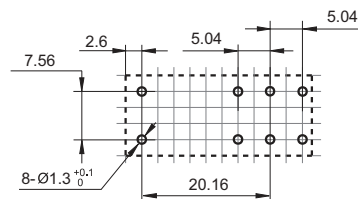

- Remark:** 1) In case of no tolerance shown in outline dimension: outline dimension ≤ 1 mm, tolerance should be ± 0.2 mm; outline dimension > 1 mm and ≤ 5 mm, tolerance should be ± 0.3 mm; outline dimension > 5 mm, tolerance should be ± 0.4 mm.
 2) The tolerance without indicating for PCB layout is always ± 0.1 mm.
 3) The width of the gridding is 2.52mm.

CHARACTERISTIC CURVES

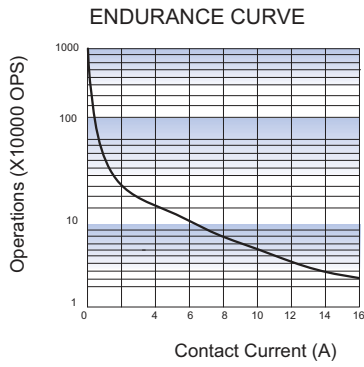

Test conditions:
 NO, resistive load, 250VAC, flux proofed,
 at 105°C, 1s on 9s off

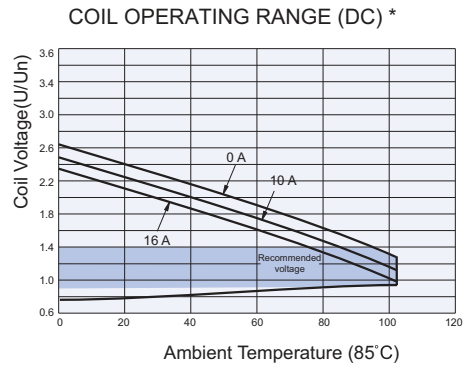

Notes: * The use of a relay with an energising voltage other than the rated coil voltage may lead to reduced electrical life. An energising voltage over the abver range may damage the insulation of relay coil.

Disclaimer

The specification is for reference only. See to 'Terminology and Guidelines' for more information. Specifications subject to change without notice. We could not evaluate all the performance and all the parameters for every possible application. Thus the user should be in a right position to choose the suitable product for their own application. If there is any query, please contact Hongfa for the technical service. However, it is the user's responsibility to determine which product should be used only.

© Xiamen Hongfa Electroacoustic Co., Ltd. All rights of Hongfa are reserved.

HF158F

MINIATURE HIGH POWER RELAY



File No.:E134517



File No.:40032833



File No.:CQC15002129497



Features

- 20A switching capability
- Low height: 15.7 mm
- 5kV dielectric strength (between coil and contacts)
- Creepage distance: 10mm, meet reinforce insulation
- UL insulation system: Class F
- Product in accordance to IEC 60335-1 available
- Sockets available
- Plastic sealed and flux proofed types available
- Environmental friendly product (RoHS compliant)
- Outline Dimensions: (29.0 x 12.7 x 15.7) mm

CONTACT DATA

Contact arrangement	1A, 1C
Contact resistance	100mΩ max.(at 1A 6VDC)
Contact material	AgNi, AgSnO ₂
Contact rating	16A 250VAC
Max. switching voltage	440VAC
Max. switching current	20A
Max. switching power	5000VA
Mechanical endurance	2 x 10 ⁷ OPS
Electrical endurance	H33 type: 1 x 10 ⁵ OPS (16A 277VAC, Resistive load, Room temp., 1s on 9s off) H3T type: 1 x 10 ⁵ OPS (16A 277VAC, Resistive load, Room temp., 1s on 9s off)

CHARACTERISTICS

Insulation resistance	1000MΩ (at 500VDC)	
Dielectric strength	Between coil & contacts	5000VAC 1min
	Between open contacts	1000VAC 1min
Surge voltage (between coil & contacts)	10kV (1.2 / 50μs)	
Operate time (at nomi. volt.)	15ms max.	
Release time (at nomi. volt.)	8ms max.	
Temperature rise (at nomi. volt.)	60K max.	
Shock resistance *	Functional	98m/s ²
	Destructive	980m/s ²
Vibration resistance *	10Hz to 150Hz 10g/5g	
Humidity	5% to 85% RH	
Ambient temperature	-40°C to 85°C	
Termination	PCB	
Unit weight	Approx. 11.5g	
Construction	Plastic sealed, Flux proofed	

Notes: 1) The data shown above are initial values.
2) * Index is not that of relay length direction.

COIL

Coil power	Approx. 400mW
------------	---------------

COIL DATA

at 23°C

Nominal Voltage VDC	Pick-up Voltage VDC max.	Drop-out Voltage VDC min.	Max. Voltage VDC ¹⁾	Coil Resistance Ω
5	3.50	0.5	9.0	62 x (1±10%)
6	4.20	0.6	10.8	90 x (1±10%)
9	6.30	0.9	16.2	202 x (1±10%)
12	8.40	1.2	21.6	360 x (1±10%)
18	12.6	1.8	32.4	810 x (1±10%)
24	16.8	2.4	43.2	1440 x (1±10%)
48 ²⁾	33.6	4.8	86.4	5760 x (1±15%)

Notes: 1) Maximum voltage refers to the maximum voltage which relay coil could endure in a short period of time.
2) For products with rated voltage ≥ 48V, measures should be taken to prevent coil overvoltage in order to protect coil in test and application (eg. Connect diodes in parallel).

SAFETY APPROVAL RATINGS

UL/CUL	AgNi	16A 277VAC 16A 24VDC 10A 400VAC at 85°C 10A 250VAC at 105°C 20A 250VAC at 85°C
	AgSnO ₂	1HP 240VAC B300/R300 at 85°C TV-5 120VAC 16A 277VAC 16A 24VDC 10A 400VAC at 85°C 10A 250VAC at 105°C 20A 250VAC at 85°C
VDE	AgNi	13A 250VAC at 70°C 16A 250VAC at 85°C NO: 10A 250VAC at 25°C / at 105°C (Only for (217) type)
	AgSnO ₂	16A 250VAC at 85°C 8A 250VAC cosφ=0.4 at 85°C
UL/CUL (HF158F-T)		16A 277VAC at 105°C
VDE (HF158F-T)		NO: 20A 250VAC at Room temp. / 105°C NO: 16A 250VAC at Room temp. / 105°C

Notes: 1) All values unspecified are at room temperature.
2) Only typical loads are listed above. Other load specifications can be available upon request.



HONGFA RELAY

ISO9001, ISO/TS16949, ISO14001, OHSAS18001, IECQ QC 080000 CERTIFIED

ORDERING INFORMATION

Type	HF158F /	12	-Z	S	3	3	(XXX)
	HF158F: Standard HF158F-T: High temperature						
Coil voltage	5, 6, 9, 12, 18, 24, 48VDC						
Contact arrangement	H: 1 Form A		Z: 1 Form C				
Construction ^{1) 2)}	S: Plastic sealed		Nil: Flux proofed				
Version	3: 5.0mm						
Contact material	3: AgNi		T: AgSnO ₂				
Special code ³⁾	XXX: Customer special requirement			Nil: Standard			

- Notes:** 1) We recommend flux proofed types for a clean environment (free from contaminations like H₂S, SO₂, NO₂, dust, etc.). We suggest to choose plastic sealed types and validate it in real application for an unclean environment (with contaminations like H₂S, SO₂, NO₂, dust, etc).
- 2) Contact is recommended for suitable condition and specifications if water cleaning or surface process is involved in assembling relays on PCB.
- 3) The customer special requirement express as special code after evaluating by Hongfa. e.g. (217) stands for product with the electrical endurance of 3×10^5 OPS at 10A load.

OUTLINE DIMENSIONS, WIRING DIAGRAM AND PC BOARD LAYOUT

Unit: mm

Outline Dimensions

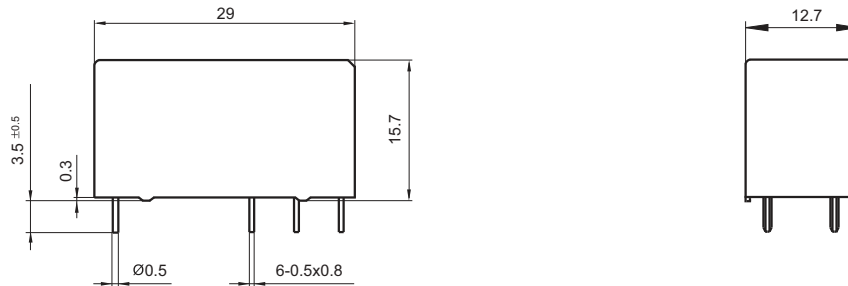

PCB Layout (Bottom view)

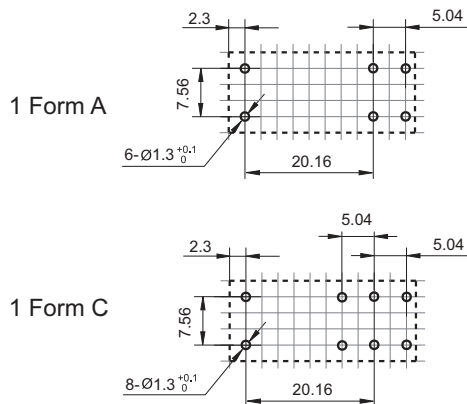

Wiring Diagram (Bottom view)

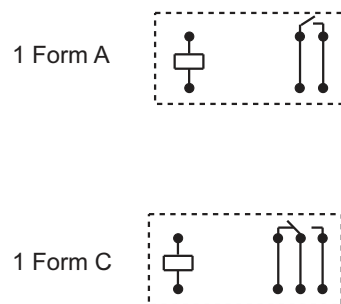

- Remark: 1) In case of no tolerance shown in outline dimension: outline dimension ≤ 1 mm, tolerance should be ± 0.2 mm; outline dimension > 1 mm and ≤ 5 mm, tolerance should be ± 0.3 mm; outline dimension > 5 mm, tolerance should be ± 0.4 mm.
- 2) The tolerance without indicating for PCB layout is always ± 0.1 mm.
- 3) The width of the gridding is 2.52mm.

CHARACTERISTIC CURVES

MAXIMUM SWITCHING POWER

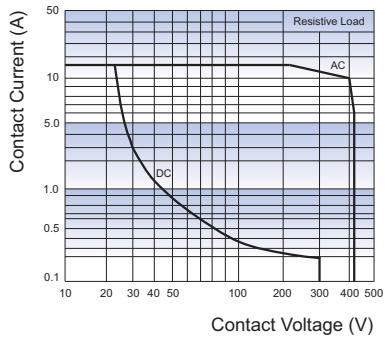

ENDURANCE CURVE

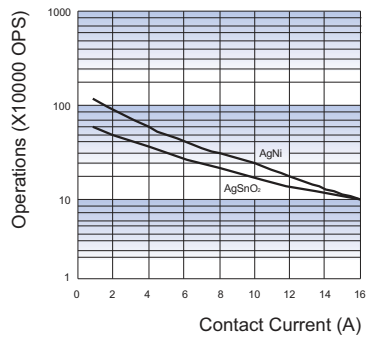

COIL OPERATING RANGE (DC) *

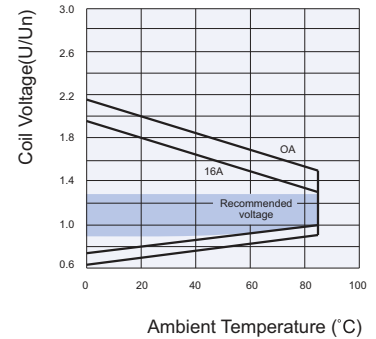

Test conditions:

NO, 250VAC, Resistive load,
Flux proofed, Room temp., 1s on 9s off.

Notes: * The use of a relay with an energising voltage

other than the rated coil voltage may lead to reduced electrical life.

An energising voltage over the above range may damage the insulation of relay coil.

Disclaimer

The specification is for reference only. See to "Terminology and Guidelines" for more information. Specifications subject to change without notice. We could not evaluate all the performance and all the parameters for every possible application. Thus the user should be in a right position to choose the suitable product for their own application. If there is any query, please contact Hongfa for the technical service. However, it is the user's responsibility to determine which product should be used only.

© Xiamen Hongfa Electroacoustic Co., Ltd. All rights of Hongfa are reserved.

HF158F-V 1 pole

MINIATURE HIGH POWER RELAY



File No.: 40032833



File No.:E134517



File No.:CQC15002129497



Features

- 10A 300VDC high-voltage switching capability
- 5kV dielectric strength(between coil and contacts)
- Creepage distance:10mm
- Meet Reinforce insulation
- Product in accordance to IEC60335-1 available
- Class F insulation system
- Environmental friendly product(RoHS compliant)
- Outline dimensions: (29.0 x 12.7 x 20.0) mm

CONTACT DATA

Contact arrangement	1A
Contact resistance	100mΩ max.(at 1A 6VDC)
Contact material	AgSnO ₂
Contact rating	10A 300VDC 12A 277VAC
Max. switching voltage	420VDC / 300VAC
Max. switching current	16A
Max. switching power	3000W / 3324VA
Mechanical endurance	2 x 10 ⁶ ops
Electrical endurance	1 x 10 ⁴ ops (10A 300VDC, Resistive load, at 85 °C, 1s on 9s off) 1 x 10 ⁴ ops (12A 277VAC, Resistive load, at 85 °C, 1s on 9s off)

COIL

Coil power	Approx. 400mW
------------	---------------

COIL DATA

at 23°C

Coil Code	Nominal Voltage VDC	Pick-up Voltage VDC max.	Drop-out Voltage VDC min.	Coil Resistance Ω
5	5	≤3.75	≥0.5	62 x (1±10%)
6	6	≤4.50	≥0.6	90 x (1±10%)
9	9	≤6.75	≥0.9	200 x (1±10%)
12	12	≤9.00	≥1.2	360 x (1±10%)
18	18	≤13.50	≥1.8	810 x (1±10%)
24	24	≤18.00	≥2.4	1440 x (1±10%)

CHARACTERISTICS

Insulation resistance	1000MΩ (at 500VDC)	
Dielectric strength	Between coil & contacts	5000VAC 1min
	Between open contacts	1500VAC 1min
Surge voltage (between coil & contacts)	10kV (1.2 / 50μs)	
Operate time (at nomi. volt.)	10ms max.	
Release time (at nomi. volt.)	5ms max.	
Shock resistance *	Functional	98m/s ²
	Destructive	980m/s ²
Vibration resistance *	10Hz to 55Hz 1.5mm DA	
Humidity	5% to 85% RH	
Ambient temperature	-40°C to 85°C	
Termination	PCB	
Unit weight	Approx. 15g	
Construction	Flux proofed	

Notes: 1) The data shown above are initial values.
2) * Index is not that of relay length direction.

SAFETY APPROVAL RATINGS

UL/CUL	10A 300VDC at 85°C
	16A 180VDC at 85°C
	12A 277VAC at 85°C
	13A 180VAC at 85°C
	14.5A 160VAC at 85°C
VDE	10A 300VDC at 85°C
	16A 180VDC at 85°C
	12A 250VAC at 85°C
	13A 180VAC at 85°C
	14.5A 160VAC at 85°C

Notes: 1) Only typical loads are listed above. Other load specifications can be available upon request.



HONGFA RELAY

ISO9001, ISO/TS16949, ISO14001, OHSAS18001, IECQ QC 080000 CERTIFIED

ORDERING INFORMATION

Type	HF158F-V /	12	-H	2	T	(XXX)
Coil voltage	5, 6, 9, 12, 18, 24VDC					
Contact arrangement	H: 1 Form A					
Version	2: 5.0mm 1 pole					
Contact material	T: AgSnO ₂					
Special code ³⁾	XXX: Customer special requirement		Nil: Standard			

- Notes:** 1) We recommend flux proofed types for a clean environment (free from contaminations like H₂S, SO₂, NO₂, dust, etc.);
 2) Storage, transportation and installation can not have a strong magnetic field around;
 3) The customer special requirement express as special code after evaluating by Hongfa;
 4) Product contains magnet, so there will be mutual exclusion or attraction between products. During the installation, please consider the installation mounting distance.

OUTLINE DIMENSIONS, WIRING DIAGRAM AND PC BOARD LAYOUT

Unit: mm

Outline Dimensions

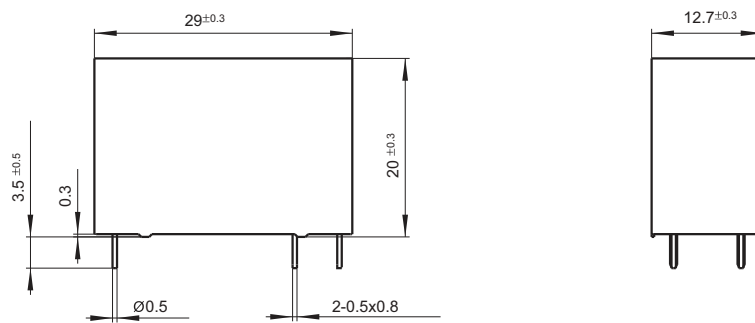

PCB Layout (Bottom view)

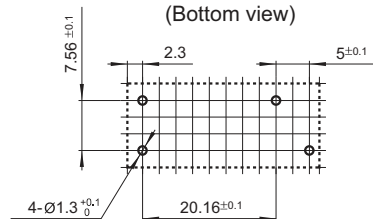

Wiring Diagram (Bottom view)



- Remark:** 1) In case of no tolerance shown in outline dimension: outline dimension ≤ 1 mm, tolerance should be ± 0.2 mm; outline dimension > 1 mm and ≤ 5 mm, tolerance should be ± 0.3 mm; outline dimension > 5 mm, tolerance should be ± 0.4 mm.
 2) The tolerance without indicating for PCB layout is always ± 0.1 mm.

CIRCUIT

Load circuit and input circuit (Bottom view)

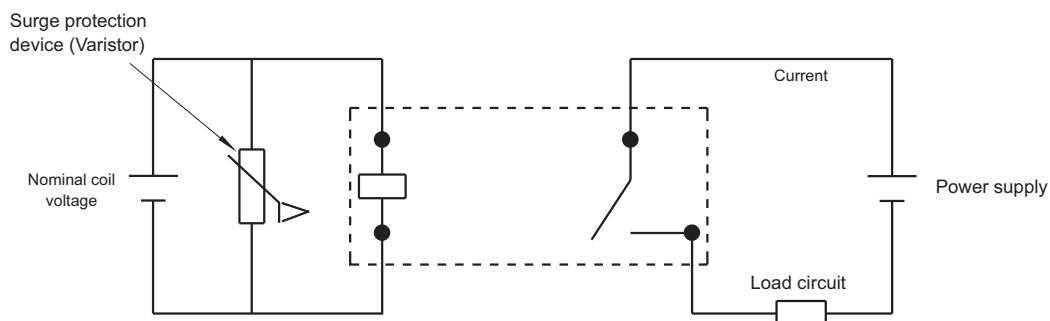

Notes:

- 1) The output contact terminals and the input coil terminal are no polarity to distinguish.
- 2) Please use varistor as surge protection device. If varistor will not be used, the electrical life need to be derated.
- 3) Varistor surge protection device should be connect parallel to coils. Suitable voltage of varistor is 3 times the coil voltage.
- 4) Avoid using relay under the strong magnetic field, which will decrease the blast function and magnetic, thus cause the arc can not be interrupted and relay damaged.
- 5) To avoid using relays under strong magnetic field because it will change the parameters of relay such as pull-in and drop-out voltage.
- 6) There is magnetic element inside, the magnetism would make the relays stick to each other, in order to avoid the sticking that may lead to deformation or parameter change inside the relay, gap is needed between the relay units.
- 7) There is magnetic element inside, the magnetism would make the relays repel each other. When more than one relay need in board layout, there should be gap between each units, in order to avoid the repel and soldering issue.

Disclaimer

The specification is for reference only. See to "Terminology and Guidelines" for more information. Specifications subject to change without notice. We could not evaluate all the performance and all the parameters for every possible application. Thus the user should be in a right position to choose the suitable product for their own application. If there is any query, please contact Hongfa for the technical service. However, it is the user's responsibility to determine which product should be used only.

© Xiamen Hongfa Electroacoustic Co., Ltd. All rights of Hongfa are reserved.

HF141FF

MINIATURE HIGH POWER RELAY



File No.:E133481



File No.:CQC09002034351



Features

- 10A switching capability
- 5kV dielectric strength (between coil and contacts)
- Sockets available
- 1 Form A, 1 Form B and 1 Form C configurations
- Plastic sealed and flux proofed types available
- Environmental friendly product (RoHS compliant)
- Outline Dimensions: (29.0 x 12.6 x 20.6) mm

CONTACT DATA

Contact arrangement	1A, 1B, 1C	
Contact resistance	50mΩ max.(at 1A 6VDC)	
Contact material	AgSnO ₂ , AgCdO	
Contact rating (Res.load)	Standard	High Capacity
	8A 250VAC /30VDC 10A 125VAC	10A 30VDC 10A 250VAC
Max. switching power	2000VA / 240W	2500VA / 300W
Max. switching current	10A	
Max. switching voltage	250VAC / 30VDC	
Mechanical endurance	1 x 10 ⁷ OPS	
Electrical endurance	Standard type: 1 x 10 ⁵ OPS (NO or NC, 8A 250VAC/30VDC, Resistive load, Room temp., 1s on 9s off),	
	High capacity type: 1 x 10 ⁵ OPS (NO or NC, 10A 250VAC/30VDC, Resistive load, Room temp., 1s on 9s off),	

Notes: For plastic sealed type, the venting-hole should be excised in electrical endurance test.

CHARACTERISTICS

Insulation resistance	1000MΩ (at 500VDC)	
Dielectric strength	Between coil & contacts	5000VAC 1min
	Between open contacts	1000VAC 1min
Operate time (at nomi. volt.)	15ms max.	
Release time (at nomi. volt.)	5ms max.	
Vibration resistance	10Hz to 55Hz 1.5mm DA	
Shock resistance	Functional	98m/s ²
	Destructive	980m/s ²
Humidity	5% to 85% RH	
Ambient temperature	-40°C to 70°C	
Termination	PCB	
Unit weight	Approx. 13g	
Construction	Plastic sealed, Flux proofed	

- Notes:** 1) The data shown above are initial values.
2) Please find coil temperature curve in the characteristic curves below.
3) UL insulation system: Class A

COIL

Coil power	Standard: Approx. 720mW; Sensitive: Approx. 550mW
------------	--

COIL DATA

at 23°C

Standard type

Nominal Voltage VDC	Pick-up Voltage VDC max.	Drop-out Voltage VDC min.	Max. Voltage VDC*	Coil Resistance Ω
5	4.0	0.5	6.5	36 x (1±10%)
6	4.8	0.6	7.8	50 x (1±10%)
9	7.2	0.9	11.7	115 x (1±10%)
12	9.6	1.2	15.6	200 x (1±10%)
18	14.4	1.8	23.4	460 x (1±10%)
24	19.2	2.4	31.2	820 x (1±10%)
48	38.4	4.8	62.4	3300 x (1±10%)

Sensitive type

Nominal Voltage VDC	Pick-up Voltage VDC max.	Drop-out Voltage VDC min.	Max. Voltage VDC*	Coil Resistance Ω
5	4.0	0.5	6.5	47 x (1±10%)
6	4.8	0.6	7.8	68 x (1±10%)
9	7.2	0.9	11.7	155 x (1±10%)
12	9.6	1.2	15.6	270 x (1±10%)
18	14.4	1.8	23.4	620 x (1±10%)
24	19.2	2.4	31.2	1100 x (1±10%)
48	38.4	4.8	62.4	4400 x (1±10%)

- Notes:** 1) When requiring pick-up voltage < 80% of nominal voltage, special order allowed.
2) *Maximum voltage refers to the maximum voltage which relay coil could endure in a short period of time.
3) Under ambient temperature, applying more than 80% of rating voltage to coil, relay will take action accordingly. But in order to meet the stated product performance, please apply rated voltage to coil.



HONGFA RELAY

ISO9001, ISO/TS16949, ISO14001, OHSAS18001, IECQ QC 080000 CERTIFIED

SAFETY APPROVAL RATINGS

UL/CUL	High Capacity	10A 30VDC/250VAC
	Standard	8A 30VDC/250VAC 10A 125VAC

Notes: 1) All values unspecified are at room temperature.

2) Only typical loads are listed above. Other load specifications can be available upon request.

ORDERING INFORMATION

Type	HF141FF / 012 -H S P G (XXX)		
Coil voltage	5, 6, 9, 12, 18, 24, 48VDC		
Contact arrangement	H:1 Form A	D:1 Form B	Z:1 Form C
Construction ¹⁾	S: Plastic sealed	Nil: Flux proofed	
Coil power	P: Standard	Nil: Sensitive	
Contact capacity	G: High capacity (AgSnO ₂)	Nil: Standard type (AgCdO)	
Special code ³⁾	XXX: Customer special requirement	Nil: Standard	

Notes: 1) Under the ambience with dangerous gas like H₂S, SO₂ or NO₂, plastic sealed type is recommended; Please test the relay in real applications. If the ambience allows, flux proofed type is preferentially recommended.

2) Contact is recommended for suitable condition and specifications if water cleaning or surface process is involved in assembling relays on PCB.

3) The customer special requirement express as special code after evaluating by Hongfa.

OUTLINE DIMENSIONS, WIRING DIAGRAM AND PC BOARD LAYOUT

Unit: mm

Outline Dimensions

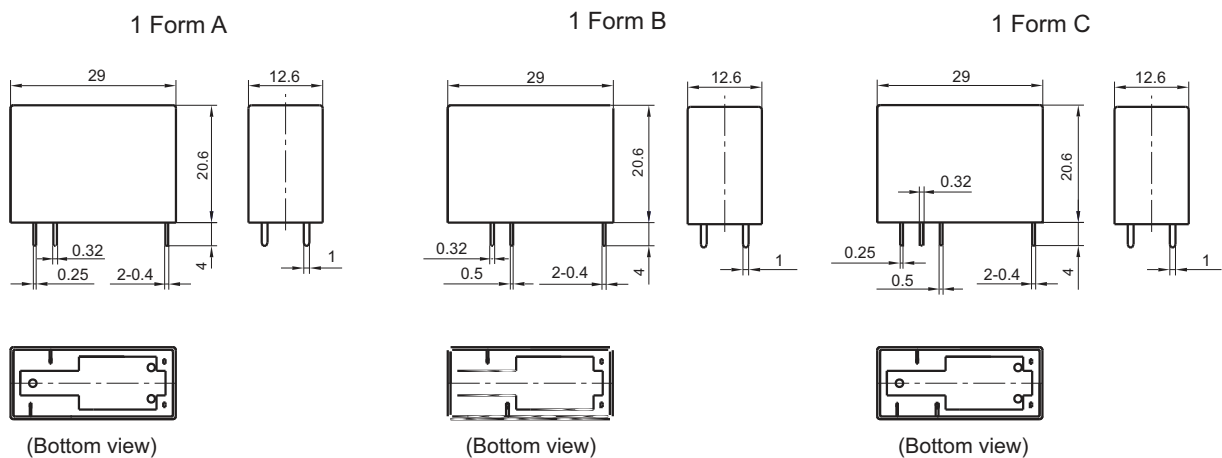

Remark: 1) In case of no tolerance shown in outline dimension: outline dimension $\leq 1\text{mm}$, tolerance should be $\pm 0.2\text{mm}$; outline dimension $> 1\text{mm}$ and $\leq 5\text{mm}$, tolerance should be $\pm 0.3\text{mm}$; outline dimension $> 5\text{mm}$, tolerance should be $\pm 0.4\text{mm}$.

2) The tolerance without indicating for PCB layout is always $\pm 0.1\text{mm}$.

OUTLINE DIMENSIONS, WIRING DIAGRAM AND PC BOARD LAYOUT

Unit: mm

PCB Layout (Bottom view)

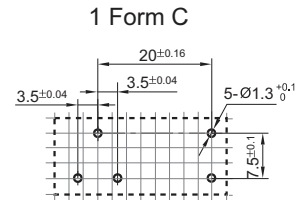
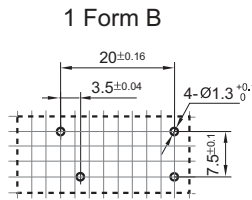
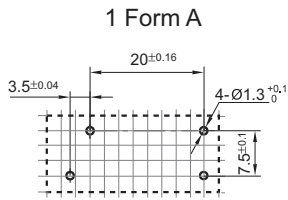

Remark: The width of the gridding is 2.5mm.

Wiring Diagram (Bottom view)



CHARACTERISTIC CURVES

MAXIMUM SWITCHING POWER

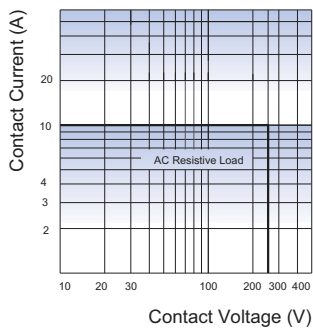

ENDURANCE CURVE

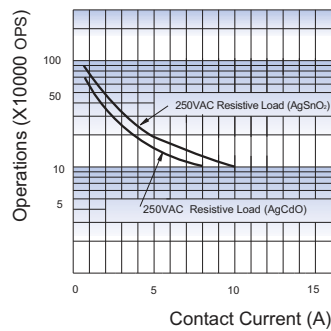

COIL TEMPERATURE RISE

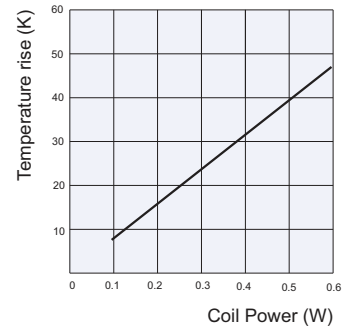

Test conditions:

No contact, Resistive load,
Flux proofed, Room temp., 1s on 9s off.

Disclaimer

The specification is for reference only. See to "Terminology and Guidelines" for more information. Specifications subject to change without notice. We could not evaluate all the performance and all the parameters for every possible application. Thus the user should be in a right position to choose the suitable product for their own application. If there is any query, please contact Hongfa for the technical service. However, it is the user's responsibility to determine which product should be used only.

HF14FF

MINIATURE HIGH POWER RELAY



File No.:E134517



File No.:R50140759



File No.:CQC10002046169



Features

- 10A switching capability
- 5kV dielectric strength (between coil and contacts)
- Sockets available
- Plastic sealed and flux proofed types available
- UL insulation system: Class F available
- Environmental friendly product (RoHS compliant)
- Outline Dimensions: (29.0 x 13.0 x 26.0) mm

CONTACT DATA

Contact arrangement	1A, 1C
Contact resistance	50mΩ max.(at 1A 24VDC)
Contact material	AgSnO ₂ , AgNi, AgCdO
Contact rating	Resistive: 10A 277VAC/30VDC TV-5 120VAC
Max. switching voltage	277VAC / 30VDC
Max. switching current	10A
Max. switching power	2770VA / 300W
Mechanical endurance	1 x 10 ⁷ OPS
Electrical endurance	1 x 10 ⁵ OPS (10A 277VAC, Resistive load, Room temp., 1s on 9s off) 1 x 10 ⁵ OPS (10A 30VDC, Resistive load, Room temp., 1s on 9s off)

Notes: For plastic sealed type, the venting-hole should be excised in electrical endurance test.

CHARACTERISTICS

Insulation resistance	1000MΩ (at 500VDC)	
Dielectric strength	Between coil & contacts	5000VAC 1min
	Between open contacts	1000VAC 1min
Operate time (at nomi. volt.)	15ms max.	
Release time (at nomi. volt.)	5ms max.	
Vibration resistance	10Hz to 55Hz 1.5mm DA	
Shock resistance	Functional	98m/s ²
	Destructive	980m/s ²
Humidity	5% to 85% RH	
Ambient temperature	-40°C to 70°C	
Termination	PCB	
Unit weight	Approx. 18g	
Construction	Plastic sealed, Flux proofed	

- Notes:** 1) The data shown above are initial values.
2) Please find coil temperature curve in the characteristic curves below.
3) UL insulation system: Class F, Class B.

COIL

Coil power	Approx. 530mW
------------	---------------

COIL DATA

at 23°C

Nominal Voltage VDC	Pick-up Voltage VDC max.	Drop-out Voltage VDC min.	Max. Voltage VDC*	Coil Resistance Ω
3	2.25	0.3	4.2	17 x (1±10%)
5	3.75	0.5	7.0	47 x (1±10%)
6	4.50	0.6	8.4	68 x (1±10%)
9	6.75	0.9	12.6	160 x (1±10%)
12	9.00	1.2	16.8	275 x (1±10%)
18	13.5	1.8	25.2	620 x (1±10%)
24	18.0	2.4	33.6	1100 x (1±10%)
48	36.0	4.8	67.2	4170 x (1±10%)
60	45.0	6.0	84.0	7000 x (1±10%)

Notes: 1) When requiring pick-up voltage < 75% of nominal voltage, special order allowed.

- 2) * Maximum voltage refers to the maximum voltage which relay coil could endure in a short period of time.
3) Under ambient temperature, applying more than 80% of rating voltage to coil, relay will take action accordingly. But in order to meet the stated product performance, please apply rated voltage to coil.

SAFETY APPROVAL RATINGS

UL/CUL	AgCdO	1 Form A	TV-5 120VAC 10A 277VAC General purpose 10A 30VDC Resistive 1/3HP 250VAC 1/4HP 125VAC
		1 Form C	TV-5 120VAC 10A 277VAC General purpose 10A 30VDC Resistive 1/3HP 250VAC NO:1/4HP 125VAC
TÜV	AgSnO ₂ AgNi		10A 277VAC General purpose 10A 30VDC Resistive 1/3HP 250VAC 1/4HP 125VAC TV-5 120VAC
			10A 250VAC 10A 30VDC

- Notes:** 1) All values unspecified are at room temperature.
2) Only typical loads are listed above. Other load specifications can be available upon request.



HONGFA RELAY

ISO9001, ISO/TS16949, ISO14001, OHSAS18001, IECQ QC 080000 CERTIFIED

ORDERING INFORMATION

Type	HF14FF / 012 -1H S T F (XXX)			
Coil voltage	3, 5, 6, 9, 12, 18, 24, 48, 60VDC			
Contact arrangement	1H: 1 Form A	1Z: 1 Form C		
Construction ¹⁾	S: Plastic sealed(No smoky-gray cover) Nil: Flux proofed			
Contact material	T: AgSnO ₂	3: AgNi	Nil: AgCdO	
Insulation standard	F: Class F	Nil: Class B		
Special code ⁴⁾	XXX: Customer special requirement		Nil: Standard	

- Notes:** 1) We recommend flux proofed types for a clean environment (free from contaminations like H₂S, SO₂, NO₂, dust, etc.). We suggest to choose plastic sealed types and validate it in real application for an unclean environment (with contaminations like H₂S, SO₂, NO₂, dust, etc).
- 2) Contact is recommended for suitable condition and specifications if water cleaning or surface process is involved in assembling relays on PCB.
- 3) The standard type is made of black cover. If smoke cover is required, please add a special suffix (611) when ordering. Please take note that smoke cover is only available for flux proofed type.
- 4) The customer special requirement express as special code after evaluating by Hongfa.

OUTLINE DIMENSIONS, WIRING DIAGRAM AND PC BOARD LAYOUT

Unit: mm

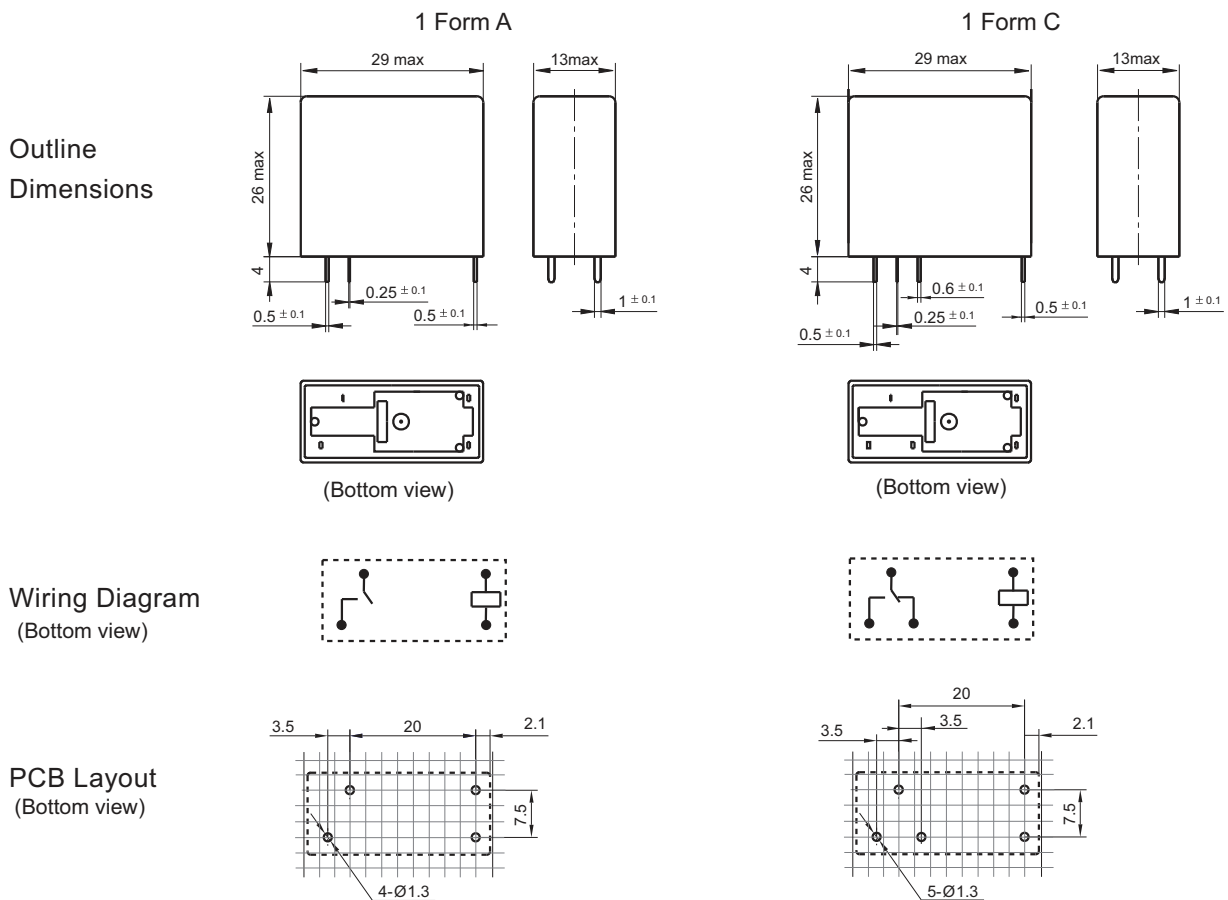

- Remark:** 1) In case of no tolerance shown in outline dimension: outline dimension ≤ 1mm, tolerance should be ±0.2mm; outline dimension > 1mm and ≤ 5mm, tolerance should be ±0.3mm; outline dimension > 5mm, tolerance should be ±0.4mm.
- 2) The tolerance without indicating for PCB layout is always ±0.1mm.
- 3) The width of the gridding is 2.5mm.

CHARACTERISTIC CURVES

ENDURANCE CURVE

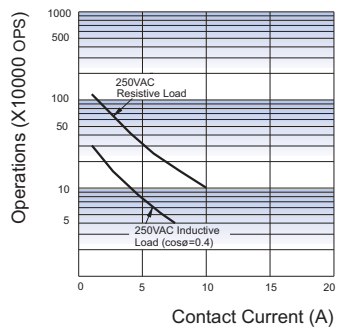

Test conditions:

No contact, Resistive load,
Flux proofed, Room temp., 1s on 9s off.

COIL TEMPERATURE RISE

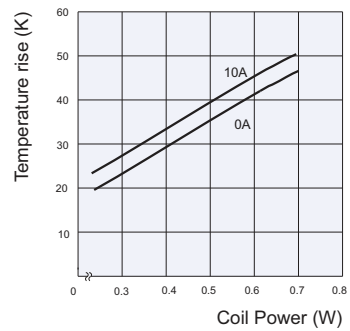

Disclaimer

The specification is for reference only. See to "Terminology and Guidelines" for more information. Specifications subject to change without notice. We could not evaluate all the performance and all the parameters for every possible application. Thus the user should be in a right position to choose the suitable product for their own application. If there is any query, please contact Hongfa for the technical service. However, it is the user's responsibility to determine which product should be used only.

HF14FW

MINIATURE HIGH POWER RELAY



File No.:E134517



File No.:40023508



File No.:CQC10002046170



Features

- 20A switching capability
- 4kV dielectric strength (between coil and contacts)
- Meeting VDE 0700, 0631 reinforce insulation
- 1 Form A, 1 Form B and 1 Form C configurations
- Sockets available
- Plastic sealed and flux proofed types available
- UL insulation system: Class F available
- Environmental friendly product (RoHS compliant)
- Outline Dimensions: (29.0 x 13.0 x 26.5) mm

CONTACT DATA

Contact arrangement	1A, 1B, 1C
Contact resistance	50mΩ max.(at 1A 24VDC)
Contact material	AgSnO ₂ , AgCdO
Contact rating	Resistive: 16A 240VAC/24VDC 1HP 240VAC TV-8 125VAC (NO contact)
Max. switching voltage	277VAC / 30VDC
Max. switching current	20A
Max. switching power	5540VA / 480W
Mechanical endurance	1 x 10 ⁷ OPS
Electrical endurance	1 x 10 ⁵ OPS (NO or NC, 16A 240VAC, Resistive load, Room temp., 1s on 9s off) 5 x 10 ⁴ OPS (NO or NC, 16A 24VDC, Resistive load, Room temp., 1s on 9s off)

Notes: For plastic sealed type, the venting-hole should be excised in electrical endurance test.

CHARACTERISTICS

Insulation resistance	1000MΩ (at 500VDC)
Dielectric strength	Between coil & contacts 4000VAC 1min
	Between open contacts 1000VAC 1min
Operate time (at nomi. volt.)	15ms max.
Release time (at nomi. volt.)	5ms max.
Ambient temperature	-40°C to 85°C
Humidity	5% to 85% RH
Shock resistance	Functional 98m/s ²
	Destructive 980m/s ²
Vibration resistance	10Hz to 55Hz 1.5mm DA
Termination	PCB
Unit weight	Approx. 18.5g
Construction	Plastic sealed, Flux proofed

- Notes:** 1) The data shown above are initial values.
2) Please find coil temperature curve in the characteristic curves below.
3) UL insulation system: Class F, Class B.

COIL

Coil power	Standard: Approx.720mW Sensitive: Approx.530mW
------------	---

COIL DATA

at 23°C

Standard type

Nominal Voltage VDC	Pick-up Voltage VDC max.	Drop-out Voltage VDC min.	Max. Voltage VDC*	Coil Resistance Ω
5	3.6	0.5	5.5	36 x (1±10%)
6	4.3	0.6	6.6	50 x (1±10%)
9	6.5	0.9	9.9	115 x (1±10%)
12	8.6	1.2	13.2	200 x (1±10%)
18	13.0	1.8	19.8	460 x (1±10%)
24	17.3	2.4	26.4	820 x (1±10%)
48	34.6	4.8	52.8	3300 x (1±10%)
60	43.2	6.0	66.0	5100 x (1±10%)

Sensitive type

Nominal Voltage VDC	Pick-up Voltage VDC max.	Drop-out Voltage VDC min.	Max. Voltage VDC*	Coil Resistance Ω
5	3.60	0.5	7.0	47 x (1±10%)
6	4.30	0.6	8.4	68 x (1±10%)
9	6.50	0.9	12.6	160 x (1±10%)
12	8.60	1.2	16.8	275 x (1±10%)
18	13.0	1.8	25.2	620 x (1±10%)
24	17.3	2.4	33.6	1100 x (1±10%)
48	34.6	4.8	67.2	4170 x (1±10%)
60	43.2	6.0	84.0	7000 x (1±10%)

- Notes:** 1) When requiring pick-up voltage < 72% of nominal voltage, special order allowed.
2) Suggesting to use the sensitive type.
3) *Maximum voltage refers to the maximum voltage which relay coil could endure in a short period of time.
4) Under ambient temperature, applying more than 80% of rating voltage to coil, relay will take action accordingly. But in order to meet the stated product performance, please apply rated voltage to coil.



HONGFA RELAY

ISO9001, ISO/TS16949, ISO14001, OHSAS18001, IECQ QC 080000 CERTIFIED

SAFETY APPROVAL RATINGS

UL/CUL	Standard, Sensitive	AgSnO ₂	20A/16A/12A 277VAC Resistive 1HP (8 FLA) 240VAC TV-8 125VAC 16A 240VAC General Use 20A/16A/12A 24VDC 10FLA 60LRA 250VAC
		AgCdO	20A/16A/12A 277VAC Resistive 1HP (8 FLA) 240VAC 16A 240VAC General Use 20A/16A/12A 24VDC 20A 125VAC General Use
	(136)	AgSnO ₂	20A 125VAC Resistive 20A 277VAC/250VAC/125VAC General Use 16A 277VAC/250VAC/125VAC Resistive 20A 30VDC Resistive 1/2HP 250VAC/125VAC TV-10 125VAC 10FLA 60LRA 250VAC
VDE (Coil power is 530mW)	AgSnO ₂	1 Form A	20A 250VAC at 70°C 16A 30VDC at 70°C
		1 Form C	16A 250VAC at 70°C 16A 30VDC at 70°C NO:20A 250VAC at 70°C

Notes: 1) All values unspecified are at room temperature.

2) Only typical loads are listed above. Other load specifications can be available upon request.

ORDERING INFORMATION

Type	HF14FW / 012 -H S P T F (XXX)						
Coil voltage	5, 6, 9, 12, 18, 24, 48, 60VDC						
Contact arrangement	H: 1Form A D: 1 Form B Z: 1 Form C						
Construction ¹⁾	S: Plastic sealed(No smoky-gray cover) Nil: Flux proofed						
Coil power	P: Standard Nil: Sensitive						
Contact material	T: AgSnO ₂ Nil: AgCdO						
Insulation standard	F: Class F Nil: Class B						
Special code ⁴⁾	XXX: Customer special requirement Nil: Standard						

Notes: 1) We recommend flux proofed types for a clean environment (free from contaminations like H₂S, SO₂, NO₂, dust, etc.).

We suggest to choose plastic sealed types and validate it in real application for an unclean environment (with contaminations like H₂S, SO₂, NO₂, dust, etc).

2) Contact is recommended for suitable condition and specifications if water cleaning or surface process is involved in assembling relays on PCB.

3) The standard type is made of black cover. If smoky-gray cover is required, please add a special suffix (611) when ordering. Please take note that smoky-gray cover is only available for flux proofed.

4) The customer special requirement express as special code after evaluating by Hongfa.

OUTLINE DIMENSIONS, WIRING DIAGRAM AND PC BOARD LAYOUT

Unit: mm

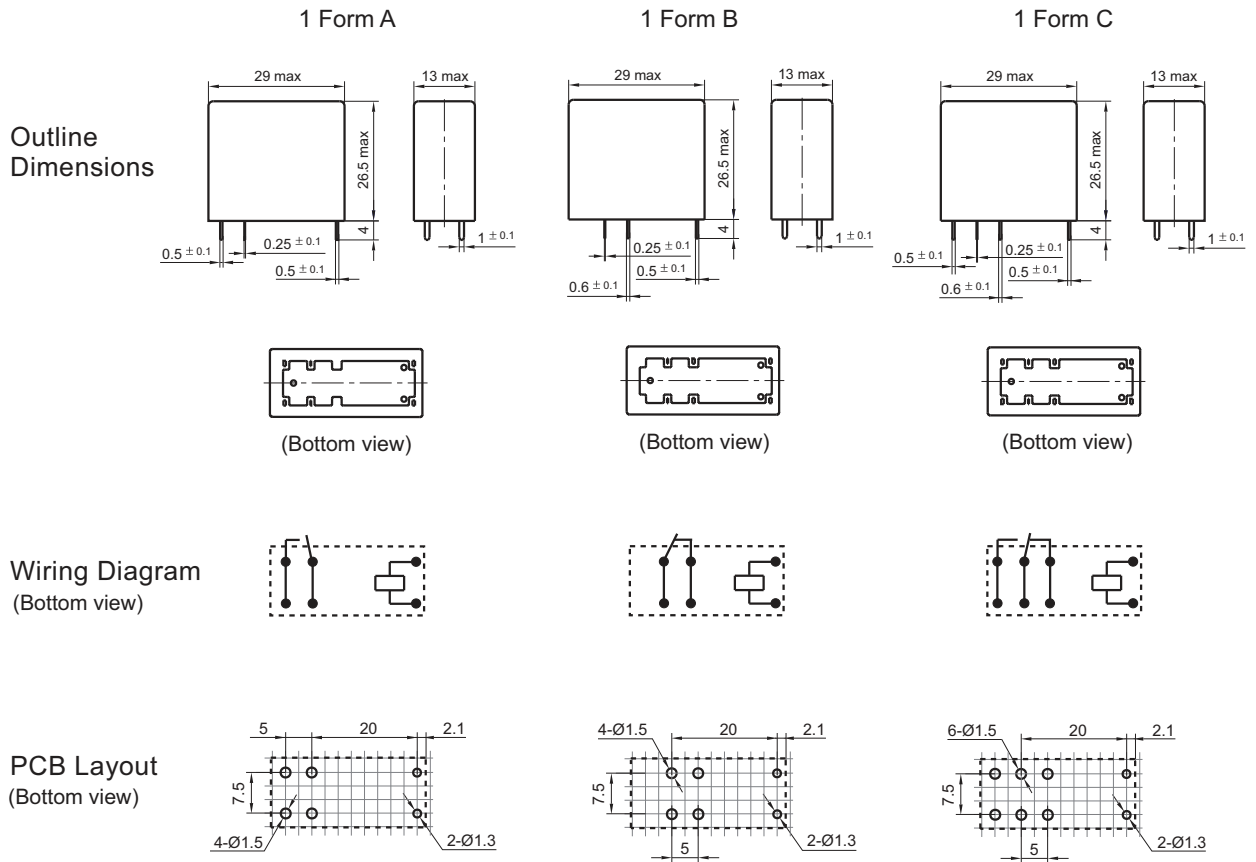

Remark: 1) In case of no tolerance shown in outline dimension: outline dimension $\leq 1\text{mm}$, tolerance should be $\pm 0.2\text{mm}$; outline dimension $> 1\text{mm}$ and $\leq 5\text{mm}$, tolerance should be $\pm 0.3\text{mm}$; outline dimension $> 5\text{mm}$, tolerance should be $\pm 0.4\text{mm}$.
 2) The tolerance without indicating for PCB layout is always $\pm 0.1\text{mm}$.
 3) The width of the gridding is 2.5mm.

CHARACTERISTIC CURVES

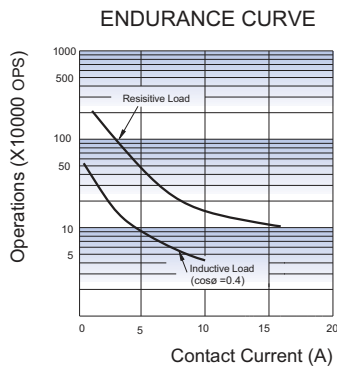

Test conditions:
 No contact, Resistive load,
 Flux proofed, Room temp., 1s on 9s off.

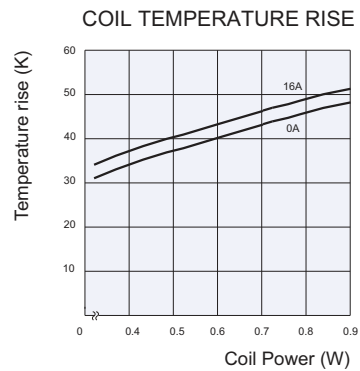

Disclaimer

The specification is for reference only. See to "Terminology and Guidelines" for more information. Specifications subject to change without notice. We could not evaluate all the performance and all the parameters for every possible application. Thus the user should be in a right position to choose the suitable product for their own application. If there is any query, please contact Hongfa for the technical service. However, it is the user's responsibility to determine which product should be used only.

© Xiamen Hongfa Electroacoustic Co., Ltd. All rights of Hongfa are reserved.

HF140FF

MINIATURE INTERMEDIATE POWER RELAY



File No.:E134517



File No.:R50149131



File No.:CQC10002046173



Features

- 10A switching capability
- 5kV dielectric strength (between coil and contacts)
- 2.0mm contact gap available
- Sockets available
- Plastic sealed and flux proofed types available
- UL insulation system: Class F available
- Environmental friendly product (RoHS compliant)
- Outline Dimensions: (29.0 x 13.0 x 26.3) mm

CONTACT DATA

Contact arrangement	2A, 2C
Contact resistance	50mΩ max.(at 1A 24VDC)
Contact material	AgSnO ₂ , AgNi, AgCdO
Contact rating (Res. load)	10A 250VAC 8A 30VDC
Max. switching voltage	250VAC / 30VDC
Max. switching current	10A
Max. switching power	2500VA / 240W
Mechanical endurance	Standard: 1 x 10 ⁷ OPS W type(1.5mm): 5 x 10 ⁵ OPS W type(2.0mm): 3 x 10 ⁵ OPS
Electrical endurance	1 x 10 ⁵ OPS (NO or NC, 10A 250VAC, Resistive load, Room temp., 1s on 9s off) 1 x 10 ⁵ OPS (NO or NC, 8A 30VDC, Resistive load, Room temp., 1s on 9s off)

Notes: For plastic sealed type, the venting-hole should be excised in electrical endurance test.

CHARACTERISTICS

Insulation resistance	1000MΩ (at 500VDC)	
Dielectric strength	Between coil & contacts	5000VAC 1min
	Between contacts sets	3000VAC 1min
	Between open contacts	Standard:1000VAC 1min W type(1.5mm):2000VAC 1min W type(2.0mm):2500VAC 1min
Surge voltage (between coil & contacts)	10kV (1.2/50 μs)	
Operate time (at nomi. volt.)	15ms max.	
Release time (at nomi. volt.)	5ms max.	
Humidity	5% to 85% RH	
Ambient temperature	-40°C to 85°C	
Shock resistance	Functional	98m/s ²
	Destructive	980m/s ²
Vibration resistance	10Hz to 55Hz 1.5mmDA	
Termination	PCB	
Unit weight	Approx. 18g	
Construction	Plastic sealed, Flux proofed	

Notes: 1) The data shown above are initial values.

2) Please find coil temperature curve in the characteristic curves below.

3) UL insulation system: Class F, Class B.

COIL

Coil power	Standard: Approx. 530mW
	W type(1.5mm): Approx. 800mW
	W type(2.0mm): Approx. 1.4W

COIL DATA

at 23°C

Standard type

Nominal Voltage VDC	Pick-up Voltage VDC max.	Drop-out Voltage VDC min.	Max. Voltage VDC *	Coil Resistance Ω
3	2.40	0.3	3.9	17 x (1±10%)
5	4.00	0.5	6.5	47 x (1±10%)
6	4.80	0.6	7.8	68 x (1±10%)
9	7.20	0.9	11.7	160 x (1±10%)
12	9.60	1.2	15.6	275 x (1±10%)
18	14.40	1.8	23.4	620 x (1±10%)
24	19.20	2.4	31.2	1100 x (1±10%)
48	38.40	4.8	62.4	4170 x (1±10%)
60	48.00	6.0	78.0	7000 x (1±10%)



HONGFA RELAY

ISO9001, ISO/TS16949, ISO14001, OHSAS18001, IECQ QC 080000 CERTIFIED

COIL DATA

at 23°C

W Type (1.5mm)

Nominal Voltage VDC	Pick-up Voltage VDC max.	Drop-out Voltage VDC min.	Max. Allowable Voltage VDC*	Coil Resistance Ω
3	2.25	0.3	3.3	11.3 x (1±10%)
5	3.75	0.5	5.5	31 x (1±10%)
6	4.50	0.6	6.6	45 x (1±10%)
9	6.75	0.9	9.9	101 x (1±10%)
12	9.00	1.2	13.2	180 x (1±10%)
18	13.5	1.8	19.8	405 x (1±10%)
24	18.0	2.4	26.4	720 x (1±10%)
48	36.0	4.8	52.8	2880 x (1±10%)
60	45.0	6.0	66.0	4500 x (1±10%)

W Type (2.0mm)

Nominal Voltage VDC	Pick-up Voltage VDC max.	Drop-out Voltage VDC min.	Max. Allowable Voltage VDC*	Coil Resistance Ω
5	3.75	0.5	5.5	18 x (1±10%)
6	4.50	0.6	6.6	26 x (1±10%)
9	6.75	0.9	9.9	58 x (1±10%)
12	9.00	1.2	13.2	102 x (1±10%)
24	18.0	2.4	26.4	410 x (1±10%)
48	36.0	4.8	52.8	1650 x (1±10%)

Notes: 1) When require pick-up voltage < 75% of nominal voltage, special order allowed.

2) *Maximum voltage refers to the maximum voltage which relay coil could endure in a short period of time.

3) Under ambient temperature, applying more than 80% of rating voltage to coil, relay will take action accordingly. But in order to meet the stated product performance, please apply rated voltage to coil.

4) For the CO version whose contact gap is 1.5 mm, the operation voltage ≤85% of rated voltage.

SAFETY APPROVAL RATINGS

UL/CUL	Standard	AgCdO		TV-3 125VAC 10A 250VAC 10A 30VDC 1/4HP 240VAC 1/8HP 120VAC
		AgNi		10A 250VAC 10A 30VDC 12A 277VAC/250VAC Resistive at 70°C 1/3HP 125VAC at 40°C
		AgSnO ₂	2 Form A	10A 250VAC 10A 30VDC 12A 277VAC/250VAC Resistive at 70°C 1/3HP 125VAC at 40°C 3/4HP 250VAC at 40°C
			2 Form C	10A 250VAC 10A 30VDC 12A 277VAC/250VAC Resistive at 70°C 1/3HP 125VAC at 40°C 3/4HP 250VAC at 40°C
	W type	AgCdO	2 Form A	TV-3 125VAC 10A 250VAC
		AgSnO ₂	2 Form A	12A 277VAC/250VAC Resistive at 70°C 1/3HP 125VAC at 40°C 3/4HP 250VAC at 40°C
TÜV		AgCdO	2 Form A 2 Form C	10A 250VAC 10A 30VDC
		AgNi	2 Form A	12A 250VAC
			2 Form C	10A 250VAC
		AgSnO ₂	2 Form A	12A 250VAC

Notes: 1) All values unspecified are at room temperature.

2) Only typical loads are listed above. Other load specifications can be available upon request.

ORDERING INFORMATION

Type	HF140FF/	012	-2H	S	W	T	G	F	(XXX)
Coil voltage	3, 5, 6, 9, 12, 18, 24, 48, 60VDC								
Contact arrangement	2H: 2 Form A 2Z: 2 Form C								
Construction ¹⁾²⁾	S: Plastic sealed(No smoky-gray cover) Nil: Flux proofed								
Contact Gap	W: Large contact gap(Only for 2 Form A) ³⁾ Nil: Standard								
Contact material	T: AgSnO ₂ 3: AgNi Nil: AgCdO								
Contact plating	G: Gold plated Nil: No gold plated								
Insulation standard	F: Class F Nil: Class B								
Special code ⁵⁾	XXX: Customer special requirement Nil: Standard								

- Notes:**1) We recommend flux proofed types for a clean environment (free from contaminations like H₂S, SO₂, NO₂, dust, etc.). We suggest to choose plastic sealed types and validate it in real application for an unclean environment (with contaminations like H₂S, SO₂, NO₂, dust, etc).
- 2) Contact is recommended for suitable condition and specifications if water cleaning or surface process is involved in assembling relays on PCB.
- 3) There are two specifications to W type: 1.5mm contact gap and 2.0mm contact gap. The default W type is 1.5mm. So please add the special code "(456)" when releasing order, if 2.0mm contact gap is required.
- 4) The standard type is made of black cover. If smoke cover is required, please add a special suffix (611) when ordering. Please take note that smoke cover is only available for flux proofed type.
- 5) The customer special requirement express as special code after evaluating by Hongfa. e.g.(456) means contact gap can reach 2.0mm.

OUTLINE DIMENSIONS, WIRING DIAGRAM AND PC BOARD LAYOUT

Unit: mm

Outline Dimensions

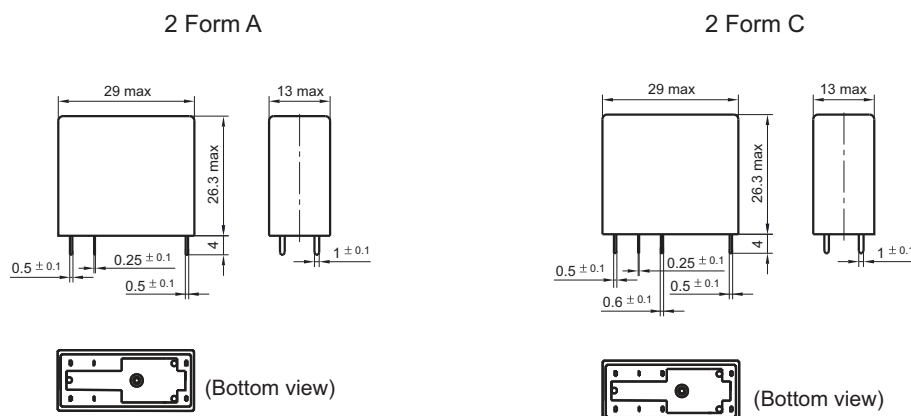

Wiring Diagram (Bottom view)



PCB Layout (Bottom view)

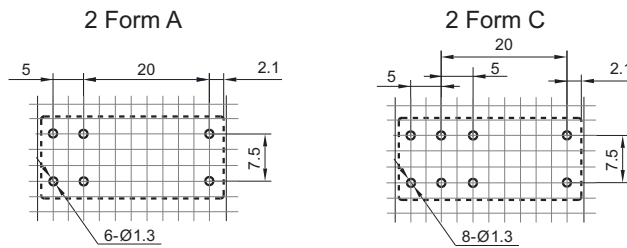

- Remark: 1) In case of no tolerance shown in outline dimension: outline dimension ≤ 1 mm, tolerance should be ± 0.2 mm; outline dimension > 1 mm and ≤ 5 mm, tolerance should be ± 0.3 mm; outline dimension > 5 mm, tolerance should be ± 0.4 mm.
 2) The tolerance without indicating for PCB layout is always ± 0.1 mm.
 3) The width of the gridding is 2.5mm.

CHARACTERISTIC CURVES

MAXIMUM SWITCHING POWER

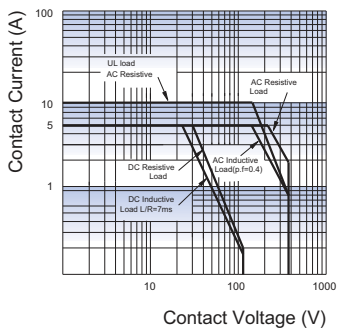

ENDURANCE CURVE

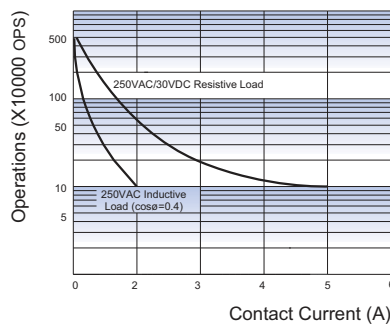

Test conditions:
 No, Resistive load, Flux proofed,
 Room temp., 1s on 9s off.

COIL TEMPERATURE RISE

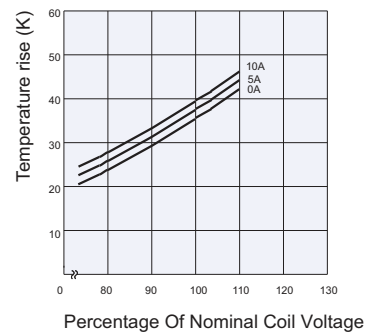

Disclaimer

The specification is for reference only. See to "Terminology and Guidelines" for more information. Specifications subject to change without notice. We could not evaluate all the performance and all the parameters for every possible application. Thus the user should be in a right position to choose the suitable product for their own application. If there is any query, please contact Hongfa for the technical service. However, it is the user's responsibility to determine which product should be used only.

HF25F

SUBMINIATURE HIGH POWER RELAY



File No.:E134517



File No.:40026917



File No.:R50207576



File No.:CQC09002028692



Features

- Small and for microwave oven
- 20A switching capability
- 1.5HP 250VAC approved by UL standard
- 5kV impulse withstand voltage (between coil and contacts)
- PCB & QC layouts
- Flux proofed types available
- Environmental friendly product (RoHS compliant)
- Outline Dimensions: (22.8 x 12.3 x 24.4) mm

CONTACT DATA

Contact arrangement	1A
Contact resistance	100mΩ max.(at 1A 6VDC)
Contact material	AgSnO ₂
Contact rating	Resistive: 20A 250VAC 1.5HP 250VAC
Max. switching voltage	250VAC / 30VDC
Max. switching current	20A
Max. switching power	5000VA / 480W
Mechanical endurance	2 x 10 ⁶ ops
Electrical endurance	1 x 10 ⁵ ops (20A 250VAC, Resistive load, Room temp., 1s on 9s off)

CHARACTERISTICS

Insulation resistance	1000MΩ (at 500VDC)	
Dielectric strength	Between coil & contacts	5000VAC 1min
	Between open contacts	1000VAC 1min
Operate time (at nomi. volt.)	15ms max.	
Release time (at nomi. volt.)	5ms max.	
Humidity	5% to 85% RH	
Shock resistance	Functional	98m/s ²
	Destructive	980m/s ²
Ambient temperature	-40°C to 85°C	
Vibration resistance	10Hz to 55Hz 1.5mm DA	
Termination	PCB & QC	
Unit weight	Approx. 16.5g	
Construction	Flux proofed	

- Notes:** 1) The data shown above are initial values.
 2) Please find coil temperature curve in the characteristic curves below.
 3) UL insulation system: Class A

COIL

Coil power	Approx. 500mW
------------	---------------

COIL DATA

at 23°C

Nominal Voltage VDC	Pick-up Voltage VDC max.	Drop-out Voltage VDC min.	Max. Voltage VDC *	Coil Resistance Ω
5	3.75	0.25	6.50	50 x (1±10%)
6	4.50	0.30	7.80	72 x (1±10%)
9	6.75	0.45	11.7	162 x (1±10%)
12	9.00	0.60	15.6	288 x (1±10%)
18	13.5	0.90	23.4	648 x (1±10%)
24	18.0	1.20	31.2	1152 x (1±10%)

- Notes:** 1) When requiring pick-up voltage <75% of nominal voltage, special order allowed.
 2) *Maximum voltage refers to the maximum voltage which relay coil could endure in a short period of time.

SAFETY APPROVAL RATINGS

UL/CUL	20A 250VAC
	16A 30VDC 1.5HP 250VAC
VDE	20A 250VAC
	16A 30VDC
TÜV	20A 250VAC
	16A 30VDC

- Notes:** 1) All values unspecified are at room temperature.
 2) Only typical loads are listed above. Other load specifications can be available upon request.



HONGFA RELAY

ISO9001, ISO/TS16949, ISO14001, OHSAS18001, IECQ QC 080000 CERTIFIED

ORDERING INFORMATION

Type	HF25F /	012	-H	1	(XXX)
Coil voltage	5, 6, 9, 12, 18, 24VDC				
Contact arrangement	H: 1 Form A				
Version	1: 1 type 2: 2 type 3: 3 type 4: 4 type Nil: Standard type				
Special code ²⁾	XXX: Customer special requirement		Nil: Standard		

Notes: 1) Contact is recommended for suitable condition and specifications if water cleaning or surface process is involved in assembling relays on PCB.

2) The customer special requirement express as special code after evaluating by Hongfa.

OUTLINE DIMENSIONS, WIRING DIAGRAM AND PC BOARD LAYOUT

Unit: mm

Standard:

Outline Dimensions

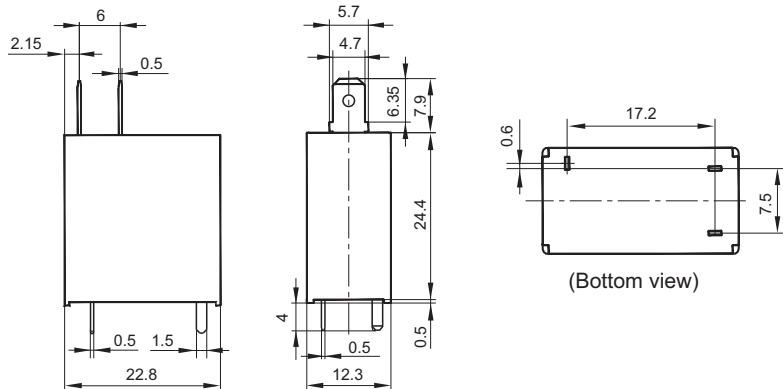

PCB Layout (Bottom view)

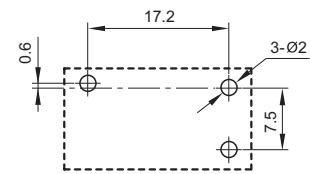

Wiring Diagram

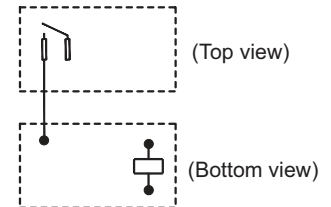

1 type:

Outline Dimensions

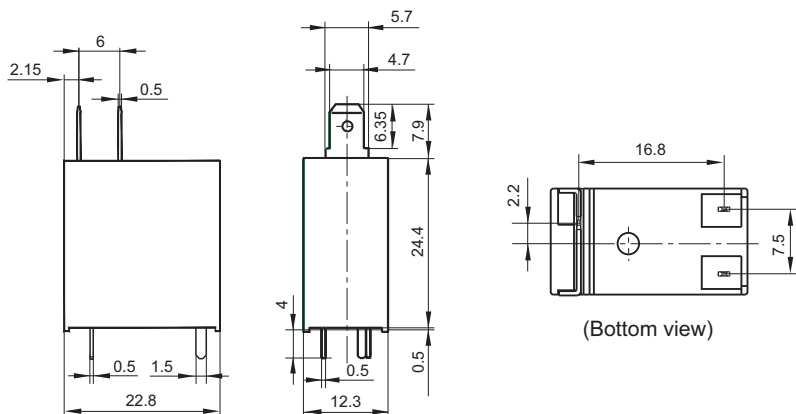

PCB Layout (Bottom view)

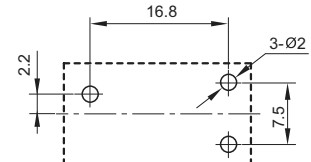

Wiring Diagram

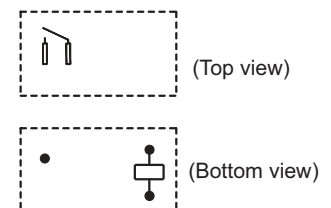

OUTLINE DIMENSIONS, WIRING DIAGRAM AND PC BOARD LAYOUT

Unit: mm

2 type:

Outline Dimensions

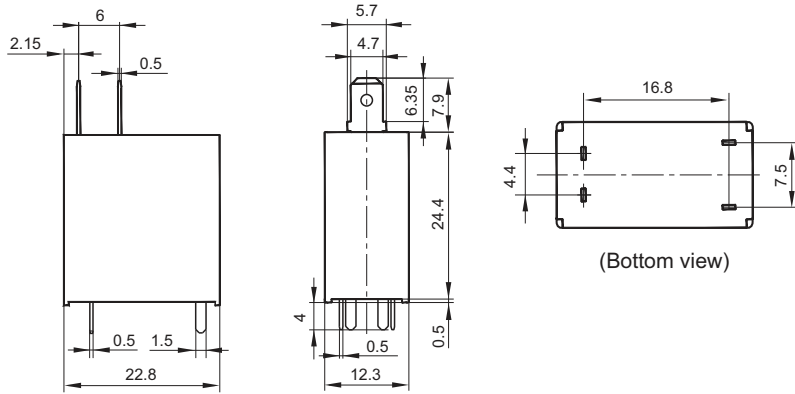

PCB Layout (Bottom view)

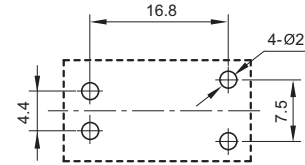

Wiring Diagram

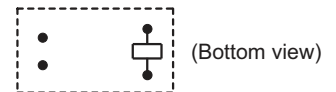

3 type:

Outline Dimensions

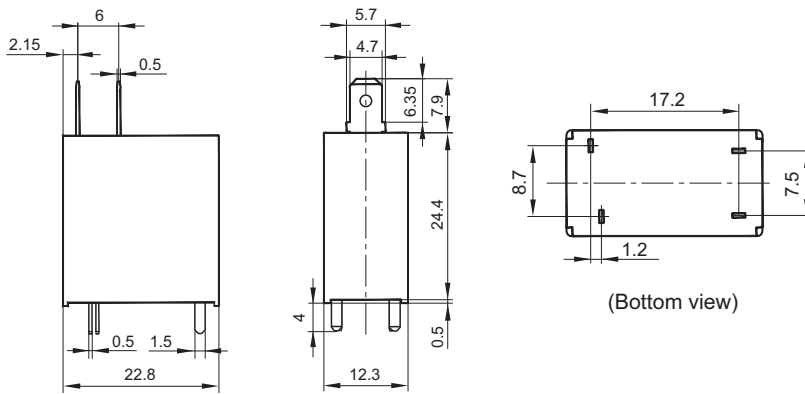

PCB Layout (Bottom view)

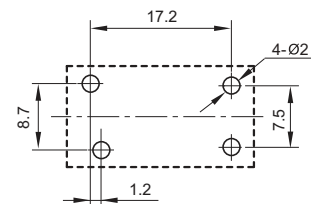

Wiring Diagram

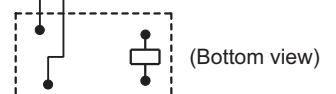
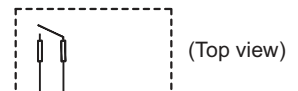

OUTLINE DIMENSIONS, WIRING DIAGRAM AND PC BOARD LAYOUT

Unit: mm

4 type:

Outline Dimensions

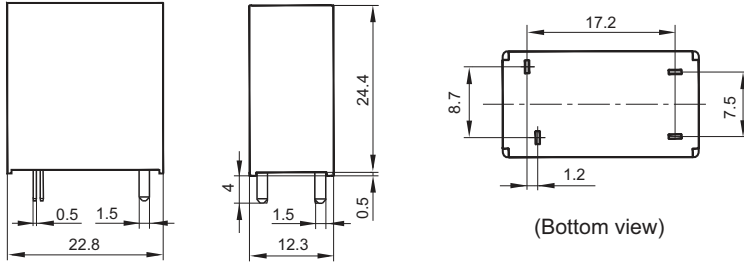

PCB Layout (Bottom view)

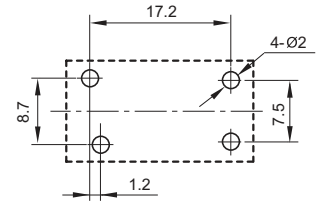

Wiring Diagram

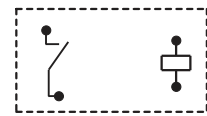

(Bottom view)

- Remark: 1) In case of no tolerance shown in outline dimension: outline dimension $\leq 1\text{mm}$, tolerance should be $\pm 0.2\text{mm}$; outline dimension $\leq 5\text{mm}$, tolerance should be $\pm 0.3\text{mm}$; outline dimension $> 5\text{mm}$, tolerance should be $\pm 0.4\text{mm}$.
 2) The tolerance without indicating for PCB layout is always $\pm 0.1\text{mm}$.

CHARACTERISTIC CURVES

MAXIMUM SWITCHING POWER

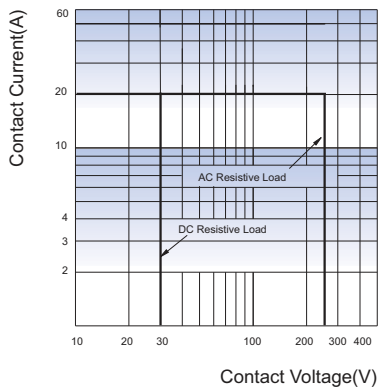

COIL TEMPERATURE RISE

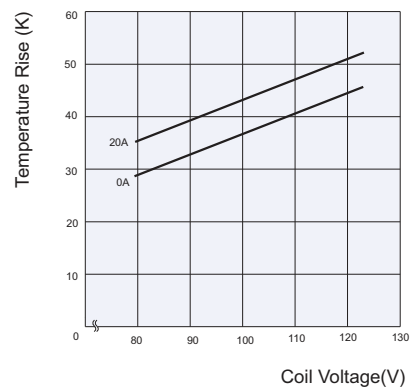

Disclaimer

The specification is for reference only. See to "Terminology and Guidelines" for more information. Specifications subject to change without notice. We could not evaluate all the performance and all the parameters for every possible application. Thus the user should be in a right position to choose the suitable product for their own application. If there is any query, please contact Hongfa for the technical service. However, it is the user's responsibility to determine which product should be used only.

© Xiamen Hongfa Electroacoustic Co., Ltd. All rights of Hongfa are reserved.

HF62F

MINIATURE HIGH POWER RELAY



File No.:E133481



File No.:R50147086



File No.:CQC09002028470



Features

- 20A switching capability
- 5kV dielectric strength (between coil and contacts)
- 10kV impulse withstand voltage (between coil and contacts)
- creepage distance: 8mm
- PCB & QC layouts available
- UL insulation system: Class F available
- Environmental friendly product (RoHS compliant)
- Outline Dimensions: (29.0 x 12.6 x 24.2) mm

CONTACT DATA

Contact arrangement	1A
Contact resistance	50mΩ max.(at 1A 6VDC)
Contact material	AgSnO ₂
Contact rating (Res. load)	16A 250VAC 16A 30VDC
Max. switching voltage	277VAC / 30VDC
Max. switching current	20A
Max. switching power	4000VAC / 480W
Mechanical endurance	1 x 10 ⁷ OPS
Electrical endurance	1 x 10 ⁵ OPS (16A 250VAC, Resistive load, Room temp., 3s on 3s off)

CHARACTERISTICS

Insulation resistance	1000MΩ (at 500VDC)	
Dielectric strength	Between coil & contacts	5000VAC 1min
	Between open contacts	1000VAC 1min
Operate time (at nomi. volt.)	20ms max.	
Release time (at nomi. volt.)	10ms max.	
Humidity	5% to 85% RH	
Ambient temperature	-40°C to 85°C	
Shock resistance	Functional	98m/s ²
	Destructive	980m/s ²
Vibration resistance	10Hz to 55Hz 1.5mm DA	
Termination	T type: PCB D type, Standard: PCB & QC	
Unit weight	Approx.15g	
Construction	Flux proofed	

- Notes:** 1) The data shown above are initial values.
2) Please find coil temperature curve in the characteristic curves below.
3) UL insulation system: Class F, Class B.

COIL

Coil power	Approx. 540mW
------------	---------------

COIL DATA

at 23°C

Nominal Voltage VDC	Pick-up Voltage VDC max.	Drop-out Voltage VDC min.	Max. Voltage VDC *	Coil Resistance Ω
5	4.0	0.5	6.50	47 x (1±10%)
6	4.8	0.6	7.80	68 x (1±10%)
9	7.2	0.9	11.7	155 x (1±10%)
12	9.6	1.2	15.6	270 x (1±10%)
18	14.4	1.8	23.4	620 x (1±10%)
24	19.2	2.4	31.2	1100 x (1±10%)
48	38.4	4.8	62.4	4400 x (1±10%)

Notes: *Maximum voltage refers to the maximum voltage which relay coil could endure in a short period of time.

SAFETY APPROVAL RATINGS

UL/CUL	16A 250VAC
	16A 30VDC
	20A 125VAC
TÜV	16A 250VAC COSØ=1
	16A 30VDC COSØ=1

- Notes:** 1) All values unspecified are at room temperature.
2) Only typical loads are listed above. Other load specifications can be available upon request.



HONGFA RELAY

ISO9001, ISO/TS16949, ISO14001, OHSAS18001, IECQ QC 080000 CERTIFIED

OUTLINE DIMENSIONS, WIRING DIAGRAM AND PC BOARD LAYOUT

Unit: mm

Wiring Diagram

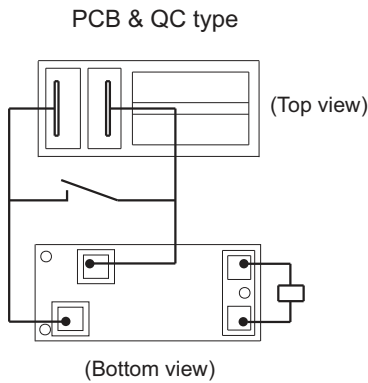

PCB type

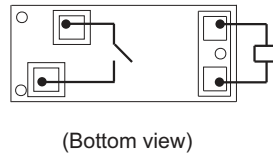

PCB Layout (Bottom view)

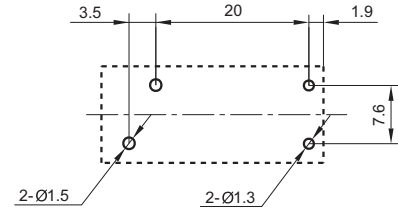

- Remark: 1) In case of no tolerance shown in outline dimension: outline dimension $\leq 1\text{mm}$, tolerance should be $\pm 0.2\text{mm}$; outline dimension $> 1\text{mm}$ and $\leq 5\text{mm}$, tolerance should be $\pm 0.3\text{mm}$; outline dimension $> 5\text{mm}$, tolerance should be $\pm 0.4\text{mm}$.
 2) The tolerance without indicating for PCB layout is always $\pm 0.1\text{mm}$.

CHARACTERISTIC CURVES

MAXIMUM SWITCHING POWER

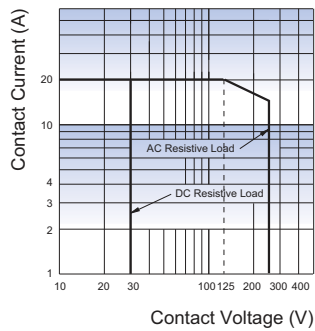

ENDURANCE CURVE

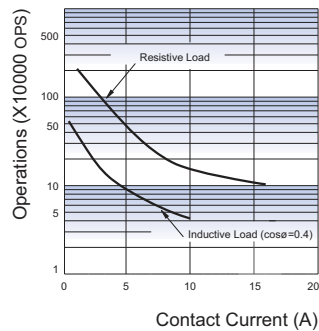

Test conditions:
 Room temp., 3s on 3s off

COIL TEMPERATURE RISE

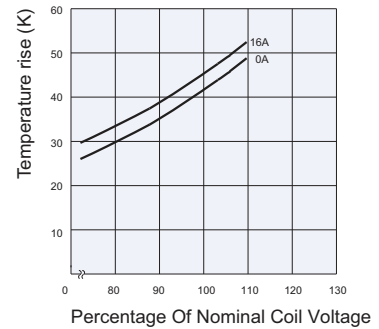

Disclaimer

The specification is for reference only. See to "Terminology and Guidelines" for more information. Specifications subject to change without notice. We could not evaluate all the performance and all the parameters for every possible application. Thus the user should be in a right position to choose the suitable product for their own application. If there is any query, please contact Hongfa for the technical service. However, it is the user's responsibility to determine which product should be used only.

HF102F

MINIATURE HIGH POWER RELAY



File No.:E134517



File No.:40024142



File No.:CQC13002098165



Features

- 4.5kV dielectric strength (between coil and contacts)
- Heavy load up to 5000VA
- Ideal for motor switching
- PCB & QC layouts available
- UL insulation system: Class F
- Environmental friendly product (RoHS compliant)
- Outline Dimensions: (30.5 x 16.0 x 23.5) mm

CONTACT DATA

Contact arrangement	1A
Contact resistance	100mΩ max.(at 1A 6VDC)
Contact material	AgSnO ₂ , AgCdO
Contact rating	Resistive: 20A 250VAC Motor: 2HP 240VAC
Max. switching voltage	250VAC
Max. switching current	Resistive: 25A
Max. switching power	6250VA
Mechanical endurance	2 x 10 ⁶ ops
Electrical endurance	1 x 10 ⁵ ops (20A 250VAC, Resistive load, at 85°C, 1.5s on 1.5s off)

COIL

Coil power	Approx. 900mW
------------	---------------

COIL DATA

at 23°C

Nominal Voltage VDC	Pick-up Voltage VDC max.	Drop-out Voltage VDC min.	Max. Voltage VDC *	Coil Resistance Ω
5	3.5	0.5	6.0	27.8 x (1±10%)
12	8.4	1.2	14.4	160 x (1±10%)
24	16.8	2.4	28.8	640 x (1±10%)
48	33.6	4.8	57.6	2560 x (1±10%)

Notes: *Maximum voltage refers to the maximum voltage which relay coil could endure in a short period of time.

CHARACTERISTICS

Insulation resistance	1000MΩ (at 500VDC)	
Dielectric strength	Between coil & contacts	4500VAC 1min
	Between open contacts	1000VAC 1min
Operate time (at nomi. volt.)	20ms max.	
Release time (at nomi. volt.)	10ms max.	
Temperature rise (at nomi. volt.)	60K max.	
Shock resistance	Functional	196m/s ²
	Destructive	980m/s ²
Vibration resistance	10Hz to 55Hz 1.5mm DA	
Ambient temperature	-25°C to 85°C	
Humidity	5% to 85% RH	
Termination	HF102F: PCB & QC HF102F-P: PCB	
Unit weight	Approx. 23g	
Construction	Dust protected	

Notes: The data shown above are initial values.

SAFETY APPROVAL RATINGS

UL/CUL	25A 250VAC
	20A 250VAC
	1HP 120VAC
	2HP 240VAC
VDE	25A 250VAC at 55°C
	20A 250VAC at 85°C

Notes: 1) All values unspecified are at room temperature.
2) Only typical loads are listed above. Other load specifications can be available upon request.



HONGFA RELAY

ISO9001, ISO/TS16949, ISO14001, OHSAS18001, IECQ QC 080000 CERTIFIED

ORDERING INFORMATION

	HF102F /	T	12VDC	(XXX)
Type	HF102F-P: PCB HF102F: PCB & QC			
Contact material	T: AgSnO ₂	Nil: AgCdO		
Coil voltage	5, 12, 24, 48VDC			
Special code²⁾	XXX: Customer special requirement	Nil: Standard		

Notes: 1) HF102F is dust protected version which cannot be washed.
2) The customer special requirement express as special code after evaluating by Hongfa.

OUTLINE DIMENSIONS, WIRING DIAGRAM AND PC BOARD LAYOUT

Unit: mm

Outline Dimensions

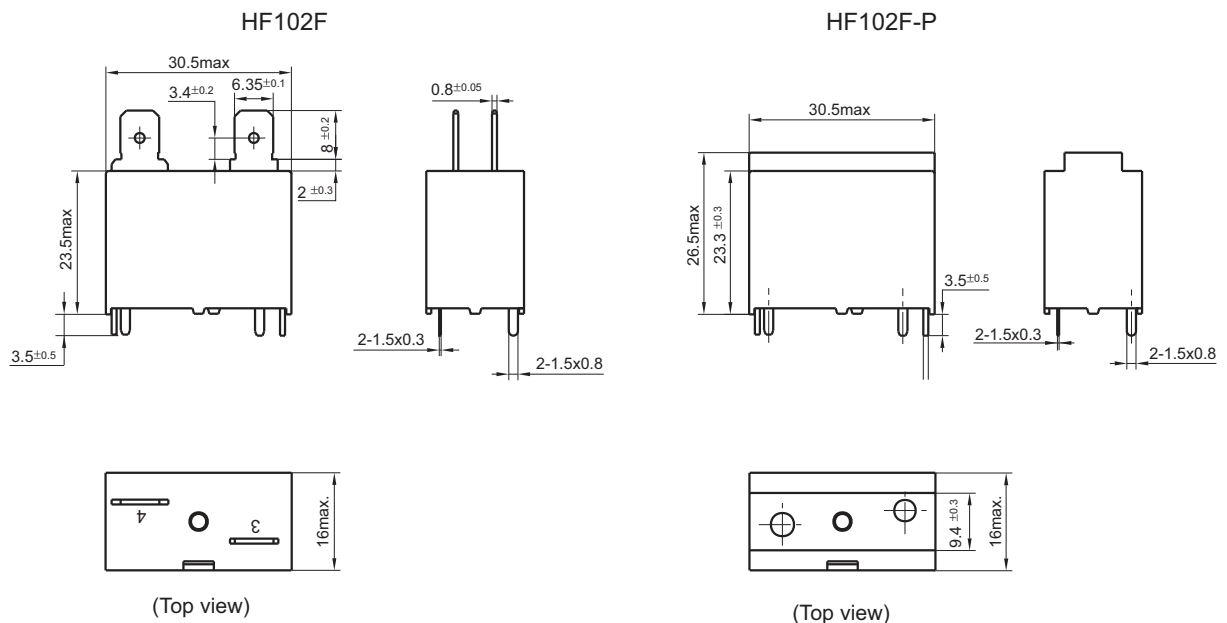

PCB Layout (Bottom view)

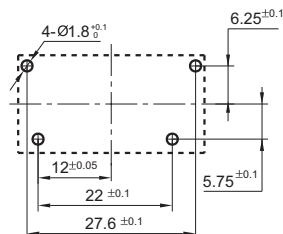

Wiring Diagram

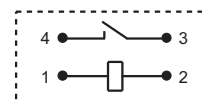

Remark: 1) In case of no tolerance shown in outline dimension: outline dimension $\leq 1\text{mm}$, tolerance should be $\pm 0.2\text{mm}$; outline dimension $> 1\text{mm}$ and $\leq 5\text{mm}$, tolerance should be $\pm 0.3\text{mm}$; outline dimension $> 5\text{mm}$, tolerance should be $\pm 0.4\text{mm}$.
2) The tolerance without indicating for PCB layout is always $\pm 0.1\text{mm}$.

CHARACTERISTIC CURVES

MAXIMUM SWITCHING POWER

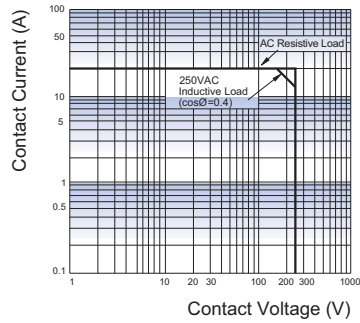

ENDURANCE CURVE

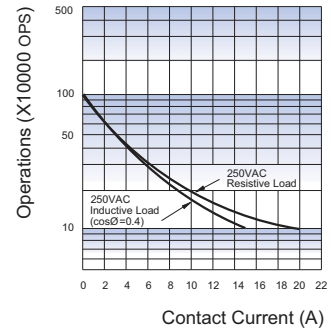

Test conditions:

Room temp. 1s on 9s off

Disclaimer

The specification is for reference only. See to "Terminology and Guidelines" for more information. Specifications subject to change without notice. We could not evaluate all the performance and all the parameters for every possible application. Thus the user should be in a right position to choose the suitable product for their own application. If there is any query, please contact Hongfa for the technical service. However, it is the user's responsibility to determine which product should be used only.

© Xiamen Hongfa Electroacoustic Co., Ltd. All rights of Hongfa are reserved.

HF161F

MINIATURE HIGH POWER RELAY



File No.: E134517



File No.: 40031410



File No.:10002050943



Features

- 4.5kV dielectric strength (between coil and contacts)
- Heavy load up to 6250VA
- Ideal for motor switching
- PCB layouts available
- UL insulation system: Class F
- Environmental friendly product (RoHS compliant)
- Outline Dimensions: (30.4 x 15.9 x 23.3) mm

CONTACT DATA

Contact arrangement	1A
Contact resistance	100mΩ max.(at 1A 6VDC)
Contact material	AgSnO ₂ , AgCdO
Contact rating	Resistive: 20A 250VAC Motor: 2HP 250VAC
Max. switching voltage	250VAC
Max. switching current	Resistive: 25A
Max. switching power	6250VA
Mechanical endurance	2 x 10 ⁶ OPS
Electrical endurance	HT type: 1 x 10 ⁵ OPS (20A 250VAC, Resistive load, Room temp., 1.5s on 1.5s off)

COIL

Coil power	Approx. 900mW
------------	---------------

COIL DATA

at 23°C

Nominal Voltage VDC	Pick-up Voltage VDC max.	Drop-out Voltage VDC min.	Max. Voltage VDC*	Coil Resistance Ω
5	3.5	0.5	6.0	27.8 x (1±10%)
12	8.4	1.2	14.4	160 x (1±10%)
24	16.8	2.4	28.8	640 x (1±10%)
48	33.6	4.8	57.6	2560 x (1±10%)

Notes: *Maximum voltage refers to the maximum voltage which relay coil could endure in a short period of time.

CHARACTERISTICS

Insulation resistance	1000MΩ (at 500VDC)	
Dielectric strength	Between coil & contacts	4500VAC 1min
	Between open contacts	1000VAC 1min
Surge voltage (between coil & contacts)	10kV (1.2 / 50μs)	
Operate time (at nomi. volt.)	20ms max.	
Release time (at nomi. volt.)	10ms max.	
Temperature rise (at nomi. volt.)	60K max.	
Shock resistance	Functional	196m/s ²
	Destructive	980m/s ²
Vibration resistance	10Hz to 55Hz 1.5mm DA	
Ambient temperature	-40°C to 85°C	
Humidity	5% to 85% RH	
Termination	PCB	
Unit weight	Approx. 21g	
Construction	Flux proofed	

Notes: The data shown above are initial values.

SAFETY APPROVAL RATINGS

UL/CUL	25A 250VAC at 85°C
	20A 250VAC at 85°C
	2HP 250VAC at 85°C
VDE	25A 250VAC at 85°C
	20A 250VAC at 85°C

Notes: 1) All values unspecified are at room temperature.
2) Only typical loads are listed above. Other load specifications can be available upon request.



HONGFA RELAY

ISO9001, ISO/TS16949, ISO14001, OHSAS18001, IECQ QC 080000 CERTIFIED

ORDERING INFORMATION

Type	HF161F /	12	-H	T	(XXX)
Coil voltage	5, 12, 24, 48VDC				
Contact arrangement	H: 1 Form A				
Contact material	T: AgSnO ₂		Nil: AgCdO		
Special code ³⁾	XXX: Customer special requirement		Nil: Standard		

Notes: 1) Water cleaning or surface process is not suggested after the flux-proofed relays are assembled on PCB.

2) Flux-proofed relays can not be used in the environment with pollutants like H₂S, SO₂, NO₂, dust, etc.

3) The customer special requirement express as special code after evaluating by Hongfa. e.g. (414) stands for product with coil terminal of 1.4X0.4.

OUTLINE DIMENSIONS, WIRING DIAGRAM AND PC BOARD LAYOUT

Unit: mm

Outline Dimensions

Standard type

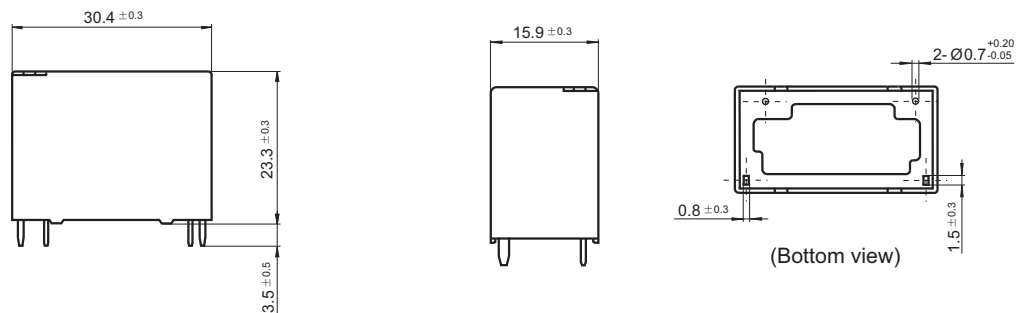

(414) special code version

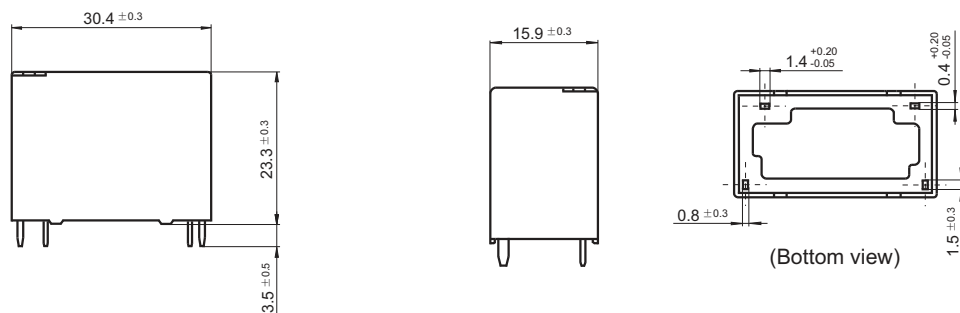

PCB Layout (Bottom view)

Standard type

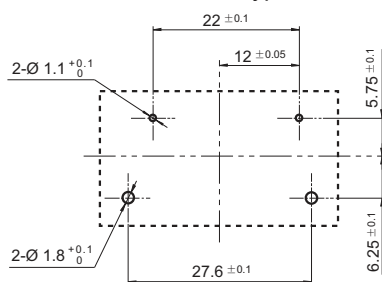

(414) special code version

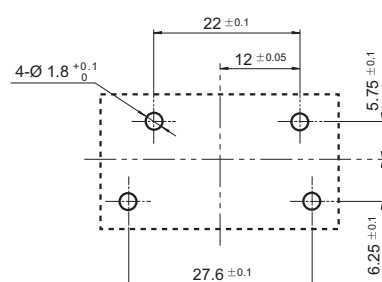

Wiring Diagram

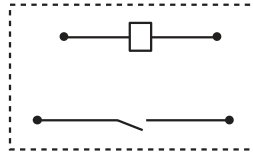

Remark: 1) In case of no tolerance shown in outline dimension: outline dimension $\leq 1\text{mm}$, tolerance should be $\pm 0.2\text{mm}$; outline dimension $> 1\text{mm}$ and $\leq 5\text{mm}$, tolerance should be $\pm 0.3\text{mm}$; outline dimension $> 5\text{mm}$, tolerance should be $\pm 0.4\text{mm}$.
 2) The tolerance without indicating for PCB layout is always $\pm 0.1\text{mm}$.

CHARACTERISTIC CURVES

MAXIMUM SWITCHING POWER

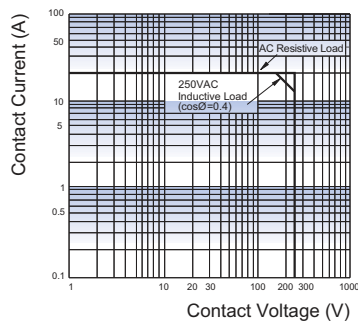

ENDURANCE CURVE

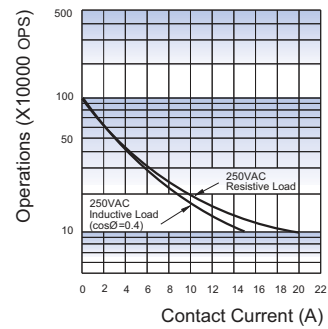

Test conditions:

Room temp., 1s on 9s off.

Disclaimer

The specification is for reference only. See to "Terminology and Guidelines" for more information. Specifications subject to change without notice. We could not evaluate all the performance and all the parameters for every possible application. Thus the user should be in a right position to choose the suitable product for their own application. If there is any query, please contact Hongfa for the technical service. However, it is the user's responsibility to determine which product should be used only.

HF161F-W

SOLAR RELAY



File No.:E134517



File No.:40031410



File No.:10002050943



Features

- 31A switching capacity
- Applicable to inverter used for photovoltaic power generation systems
- Ideal for UPS
- 1.5mm contact gap (compliant to European Photovoltaic Standard VDE0126)
- 1.8mm contact gap (compliant to IEC 62109-2-2011)
- The clearance distance between contact and coil is bigger than 6.4mm, the creepage distance is bigger than 8mm. (special code 477:7.5mm)
- Low coil holding voltage contributes to saving energy of equipment.
- UL insulation system: Class F
- Environmental friendly product (RoHS compliant)
- Outline Dimensions: (30.4 x 15.9 x 23.3) mm

CONTACT DATA

Contact gap	1.5mm	1.8mm
Contact arrangement	1A	
Contact resistance	100mΩ max.(at 1A 6VDC)	
Contact material	AgSnO ₂	
Contact rating	Resistive: 26A 250VAC Inductive: 31A 250VAC (cosφ=0.8) 0.1s:10s	Resistive: 26A 250VAC Inductive: 33A 250VAC (cosφ=0.8) 0.1s:10s
Max. switching voltage	277VAC	
Max. switching current	31A	33A
Max. switching power	7750VA	8250VA
Mechanical endurance	1 x 10 ⁶ OPS	1 x 10 ⁵ OPS
Electrical endurance	HT type: 3 x 10 ⁴ ops (26A 250VAC, Resistive load, at 75°C, 1.5s on 1.5s off)	

CHARACTERISTICS

Insulation resistance	1000MΩ (at 500VDC)	
Dielectric strength	Between coil & contacts	4500VAC 1min
	Between open contacts	2500VAC 1min
Surge voltage (between coil & contacts)	10kV (1.2/50μs)	
Operate time (at nomi. volt.)	20ms max.	
Release time (at nomi. volt.)	10ms max.	
Temperature rise (at nomi. volt.)	95K max. (Contact load current 31A, rated voltage excitation, at 60°C)	
	70K max. (Contact load current 31A, 80% of rated voltage excitation, at 85°C)	
Shock resistance	Functional	196m/s ²
	Destructive	980m/s ²
Vibration resistance	10Hz to 55Hz 1.5mm DA	
Ambient temperature	-40°C to 85°C (Apply holding voltage to coil, which is 45% to 80% that of rated voltage)	
Humidity	5% to 85% RH	
Termination	PCB	
Unit weight	Approx. 21g	
Construction	Flux proofed	

Notes: The data shown above are initial values.

COIL

Coil power	Approx. 1.4W
Holding voltage	35% to 120%UN (at 23°C)
	45% to 80%UN (at 85°C)

- Notes: 1)The coil holding voltage is the voltage of coil after being applied rated voltage for 100ms
2)The relay coil does not allow applied more than maximum of holding voltage values for a long time (Eg: 120% Un at 23°C; 80% Un at 85°C), prevent overheating burned.

COIL DATA

at 23°C

Nominal Voltage VDC	Pick-up Voltage VDC max.	Drop-out Voltage VDC min.	Max. Voltage VDC *	Coil Resistance Ω
9	6.3	0.9	10.8	58 x (1±10%)
12	8.4	1.2	14.4	103 x (1±10%)
18	12.6	1.8	21.6	230 x (1±10%)
24	16.8	2.4	28.8	410 x (1±10%)

Notes: *Maximum voltage refers to the maximum voltage which relay coil could endure in a short period of time.

SAFETY APPROVAL RATINGS

UL/CUL	AgSnO ₂	26A 277VAC at 75°C
		22A 277VAC at 85°C
VDE	AgSnO ₂	26A 277VAC at 75°C
		22A 277VAC at 85°C
		31A 250VAC cosφ=0.8 0.1s:10s 33A 250VAC cosφ=0.8 0.1s:10s (477)

- Notes: 1) All values unspecified are at room temperature.
2) Only typical loads are listed above. Other load specifications can be available upon request.



HONGFA RELAY

ISO9001, ISO/TS16949, ISO14001, OHSAS18001, IECQ QC 080000 CERTIFIED

ORDERING INFORMATION

Type	HF161F-W /	12	-H	T	(XXX)
Coil voltage	9, 12, 18, 24VDC				
Contact arrangement	H: 1 Form A				
Contact material	T: AgSnO ₂				
Special code ³⁾	XXX: Customer special requirement		Nil: Standard		

Notes: 1) Water cleaning or surface process is not suggested after the flux-proofed relays are assembled on PCB.

2) Flux-proofed relays can not be used in the environment with pollutants like H₂S, SO₂, NO₂, dust, etc.

3) The customer special requirement express as special code after evaluating by Hongfa. e.g. (414) stands for product with coil terminal of 1.4X0.4; e.g. (477) stands for Contact gap: 1.8mm.

OUTLINE DIMENSIONS, WIRING DIAGRAM AND PC BOARD LAYOUT

Unit: mm

Outline Dimensions

Standard type

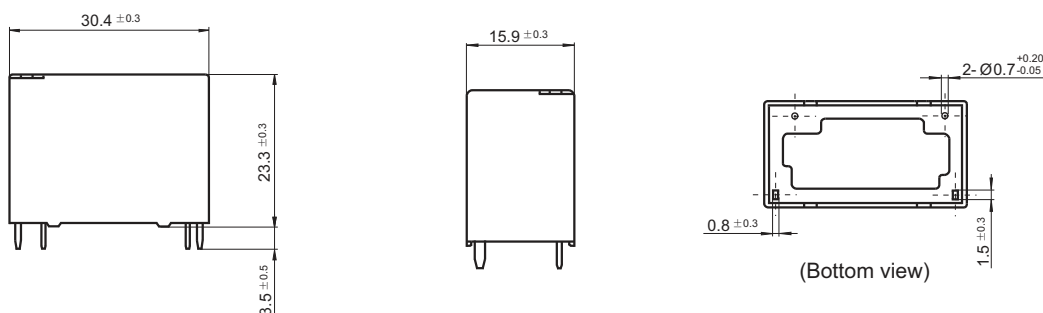

(414) special code version

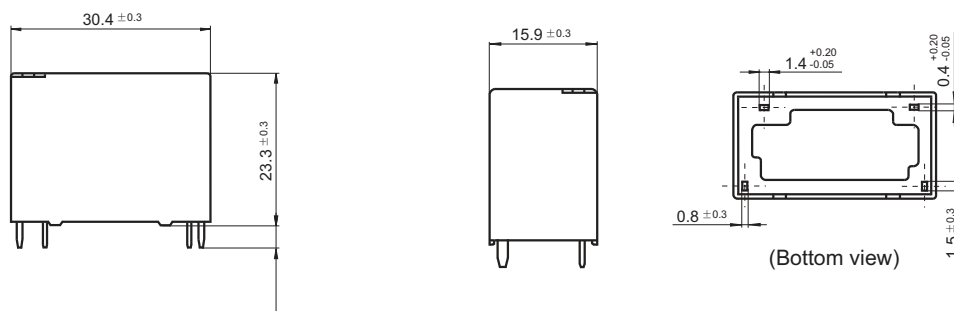

PCB Layout (Bottom view)

Standard type

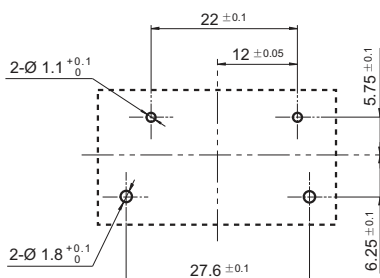

(414) special code version

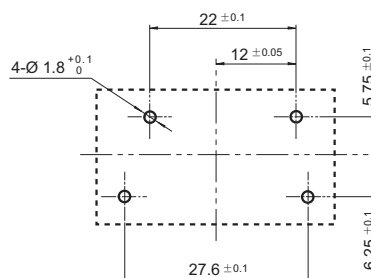

Wiring Diagram

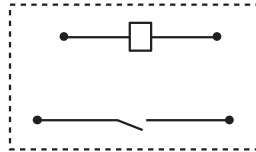

Remark: 1) In case of no tolerance shown in outline dimension: outline dimension $\leq 1\text{mm}$, tolerance should be $\pm 0.2\text{mm}$; outline dimension $> 1\text{mm}$ and $\leq 5\text{mm}$, tolerance should be $\pm 0.3\text{mm}$; outline dimension $> 5\text{mm}$, tolerance should be $\pm 0.4\text{mm}$.
 2) The tolerance without indicating for PCB layout is always $\pm 0.1\text{mm}$.

CHARACTERISTIC CURVES

MAXIMUM SWITCHING POWER

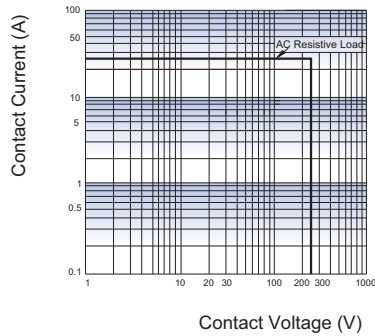

ENDURANCE CURVE

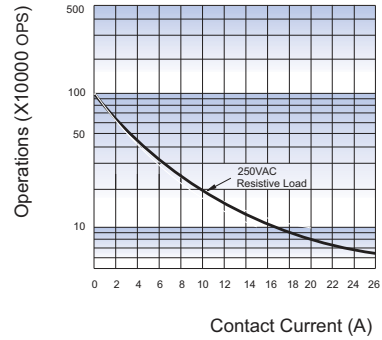

Test conditions:
 at 75°C, 1.5s on 1.5s off.

Disclaimer

The specification is for reference only. See to "Terminology and Guidelines" for more information. Specifications subject to change without notice. We could not evaluate all the performance and all the parameters for every possible application. Thus the user should be in a right position to choose the suitable product for their own application. If there is any query, please contact Hongfa for the technical service. However, it is the user's responsibility to determine which product should be used only.

HF160F

MINIATURE HIGH POWER RELAY



File No.: E134517



File No.: 40024142



File No.: CQC12002072207



Features

- 4.5kV dielectric strength (between coil and contacts)
- Heavy load up to 6250VA
- Ideal for motor switching
- PCB & QC layouts
- UL insulation system: Class F
- Environmental friendly product (RoHS compliant)
- Outline Dimensions: (30.4 x 15.9 x 25.4) mm

CONTACT DATA

Contact arrangement	1A
Contact resistance	100mΩ max.(at 1A 6VDC)
Contact material	AgSnO ₂ , AgCdO
Contact rating	Resistive: 20A 250VAC Motor: 2HP 240VAC
Max. switching voltage	Resistive: 250VAC
Max. switching current	25A
Max. switching power	6250VA
Mechanical endurance	2 x 10 ⁶ OPS
Electrical endurance	H, HT type: 1 x 10 ⁵ OPS (20A 250VAC, Resistive load, at 60°C, 1.5s on 1.5s off)

COIL

Coil power	Approx. 900mW
------------	---------------

COIL DATA

at 23°C

Nominal Voltage VDC	Pick-up Voltage VDC max.	Drop-out Voltage VDC min.	Max. Voltage VDC*	Coil Resistance Ω
5	3.5	0.5	6.0	27.8 x (1±10%)
12	8.4	1.2	14.4	160 x (1±10%)
24	16.8	2.4	28.8	640 x (1±10%)
48	33.6	4.8	57.6	2560 x (1±10%)

Notes: * Maximum voltage refers to the maximum voltage which relay coil could endure in a short period of time.

CHARACTERISTICS

Insulation resistance	1000MΩ (at 500VDC)
Dielectric strength	Between coil & contacts 4500VAC 1min
	Between open contacts 1000VAC 1min
Operate time (at nomi. volt.)	20ms max.
Release time (at nomi. volt.)	10ms max.
Temperature rise (at nomi. volt.)	60K max.
Shock resistance	Functional 196m/s ²
	Destructive 980m/s ²
Vibration resistance	10Hz to 55Hz 1.5mm DA
Ambient temperature	-40°C to 85°C
Humidity	5% to 85% RH
Termination	PCB & QC
Unit weight	Approx. 26g
Construction	Flux proofed

Notes: The data shown above are initial values.

SAFETY APPROVAL RATINGS

UL/CUL	25A 277VAC
	20A 250VAC
	1HP 120VAC
	2HP 240VAC
VDE	25A 250VAC at 55°C
	20A 250VAC at 85°C

Notes: 1) All values unspecified are at room temperature.
2) Only typical loads are listed above. Other load specifications can be available upon request.



HONGFA RELAY

ISO9001, ISO/TS16949, ISO14001, OHSAS18001, IECQ QC 080000 CERTIFIED

ORDERING INFORMATION

Type	HF160F / 12 -H 5 T (XXX)		
Coil voltage	5, 12, 24, 48VDC		
Contact arrangement	H: 1 Form A		
Termination	5: PCB & QC		
Contact material	T: AgSnO ₂	Nil: AgCdO	
Special code ³⁾	XXX: Customer special requirement	Nil: Standard	

Notes: 1) Water cleaning or surface process is not suggested after the flux-proofed relays are assembled on PCB.

2) Flux-proofed relays can not be used in the environment with pollutants like H₂S, SO₂, NO₂, dust, etc.

3) The customer special requirement express as special code after evaluating by Hongfa.

OUTLINE DIMENSIONS, WIRING DIAGRAM AND PC BOARD LAYOUT

Unit: mm

Outline Dimensions

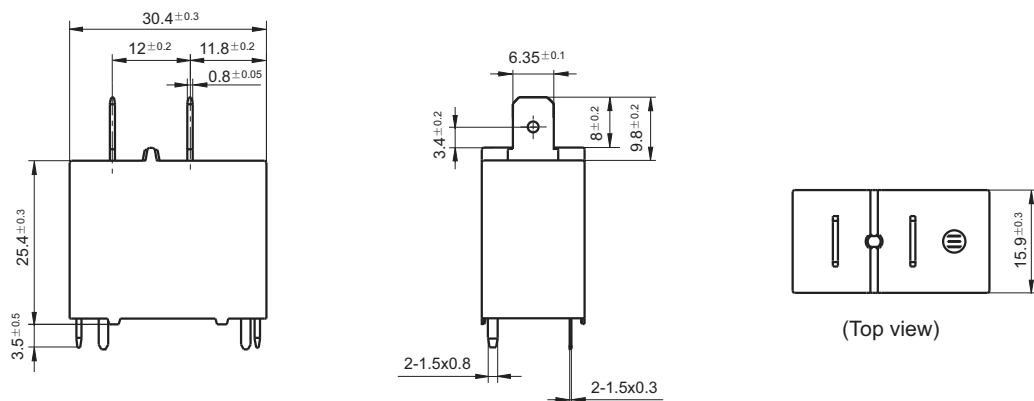

PCB Layout (Bottom view)

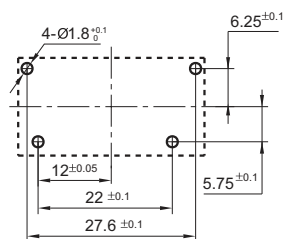

Wiring Diagram

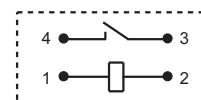

Remark: 1) In case of no tolerance shown in outline dimension: outline dimension ≤ 1 mm, tolerance should be ± 0.2 mm; outline dimension > 1 mm and ≤ 5 mm, tolerance should be ± 0.3 mm; outline dimension > 5 mm, tolerance should be ± 0.4 mm.

2) The tolerance without indicating for PCB layout is always ± 0.1 mm.

CHARACTERISTIC CURVES

MAXIMUM SWITCHING POWER

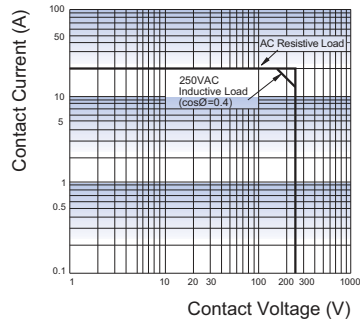

ENDURANCE CURVE

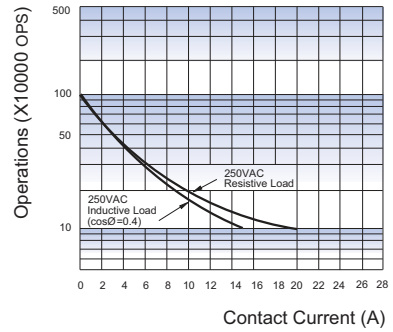

Test conditions:

Room temp., 1s on 9s off.

Disclaimer

The specification is for reference only. See to "Terminology and Guidelines" for more information. Specifications subject to change without notice. We could not evaluate all the performance and all the parameters for every possible application. Thus the user should be in a right position to choose the suitable product for their own application. If there is any query, please contact Hongfa for the technical service. However, it is the user's responsibility to determine which product should be used only.

HF166F

MINIATURE HIGH POWER LATCHING RELAY



File No.:E133481



File No.:R50280244



Features

- Latching relay
- 4mm contact gap available
- 25A switching capability
- 5kV dielectric strength(between coil and contacts)
- Creepage distance between coil and contacts:10mm
- Product in accordance to IEC 60335-1 available
- UL insulation system: Class F
- 1A + 1B configuration for power switching
- Flux proofed type available
- Outline Dimensions: (50.0 x 27.0 x 20.0) mm

CONTACT DATA

Contact arrangement	1A+1B
contact gap	4mm min.
Contact resistance	100mΩ max.(at 1A 6VDC)
Contact material	AgSnO ₂
Contact rating (Res. load)	25A 277VAC
Max. switching voltage	277VAC
Max. switching current	25A
Max. switching power	6925VA
Mechanical endurance	6 x 10 ⁵ OPS
Electrical endurance	3 x 10 ⁴ OPS (NO or NC, 25A 277VAC, Resistive load, at 85°C, 1s on 9s off)

CHARACTERISTICS

Insulation resistance	1000MΩ (at 500VDC)	
Dielectric strength	Between coil & contacts	5000VAC 1min
	Between open contacts	2000VAC 1min
Surge voltage (between coil & contacts)	10kV (1.2/50μs)	
Set time (at nomi. volt.)	25ms max.	
Reset time (at nomi. volt.)	25ms max.	
Shock resistance	Functional	100m/s ²
	Destructive	1000m/s ²
Vibration resistance	10Hz to 55Hz 2mm DA	
Humidity	5% to 85% RH	
Ambient temperature	-40°C to 85°C	
Termination	PCB	
Unit weight	Approx. 45g	
Construction	Flux proofed	

Notes: 1) The data shown above are initial values.

COIL

Coil power	1 coil latching: 1.2W 2 coils latching: 2.4W
------------	---

COIL DATA

at 23°C

1 coil latching

Nominal Voltage VDC	Set Voltage VDC max.	Pulse width (ms) min.	Reset Voltage VDC max.	Coil Resistance Ω
5	4	150	4	20.8x (1±10%)
6	4.8	150	4.8	30x (1±10%)
12	9.6	150	9.6	120x (1±10%)
24	19.2	150	19.2	480x (1±10%)
48	38.4	150	38.4	1920x (1±10%)

2 coils latching

Nominal Voltage VDC	Set Voltage VDC max.	Pulse width (ms) min.	Reset Voltage VDC max.	Coil Resistance Ω
5	4	150	4	10.4x (1±10%)
6	4.8	150	4.8	15x (1±10%)
12	9.6	150	9.6	60x (1±10%)
24	19.2	150	19.2	240x (1±10%)
48	38.4	150	38.4	960x (1±10%)

SAFETY APPROVAL RATINGS

UL/CUL	25A 277VAC/250VAC/125VAC at 85°C 25A 60VDC at 85°C 0.5A 240VDC at 85°C
TÜV	25A 400VDC, at 85°C, ON:5S, OFF:5S, Contacts break without load 70A 72VDC, at 85°C, ON:0.3S, OFF:9S, Contacts break without load 25A 277VAC/250VAC/125VAC at 85°C 25A 60VDC at 85°C 0.5A 240VDC at 85°C

Notes: 1) All values unspecified are at room temperature.

2) Only typical loads are listed above. Other load specifications can be available upon request.



HONGFA RELAY

ISO9001, ISO/TS16949, ISO14001, OHSAS18001, IECQ QC 080000 CERTIFIED

ORDERING INFORMATION

Type	HF166F /	12	-1HD	L2	T	(XXX)
Coil voltage	5, 6, 12, 24, 48VDC					
Contact arrangement	1HD: 1A + 1B					
Sort	L1: 1 coil latching		L2: 2 coils latching			
Contact material	T: AgSnO ₂					
Special code ³⁾	XXX: Customer special requirement		Nil: Standard			

- Notes: 1) Flux-proofed relays can not be used in the environment with pollutants like H₂S, SO₂, NO₂, dust, etc.
 2) Water cleaning or surface process is not suggested after the flux-proofed relays are assembled on PCB.
 3) The customer special requirement express as special code after evaluating by Hongfa.

OUTLINE DIMENSIONS, WIRING DIAGRAM AND PC BOARD LAYOUT

Unit: mm

Outline Dimensions

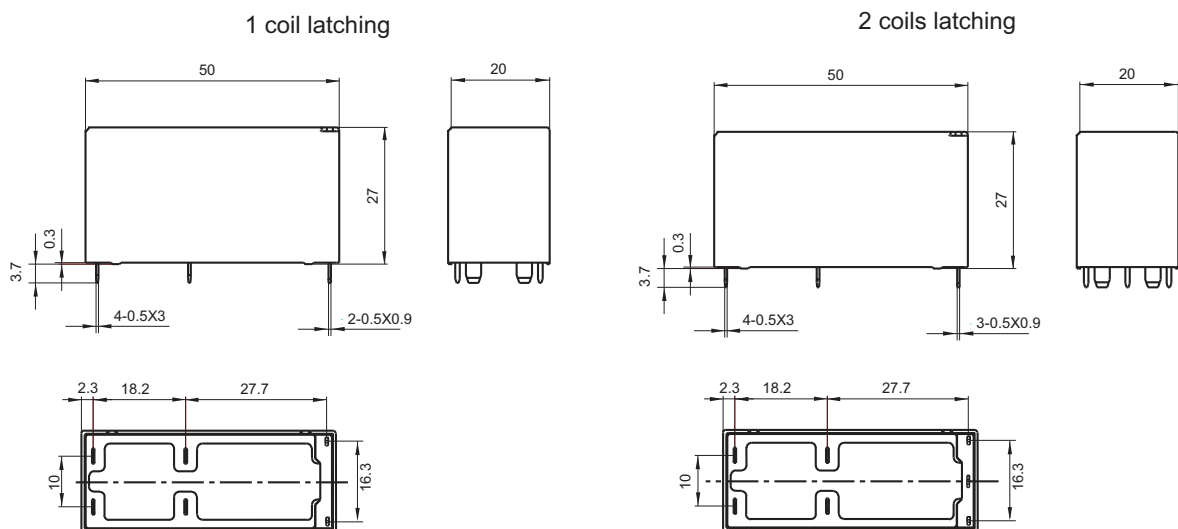

Wiring Diagram(Bottom view)



PCB Layout
(Bottom view)

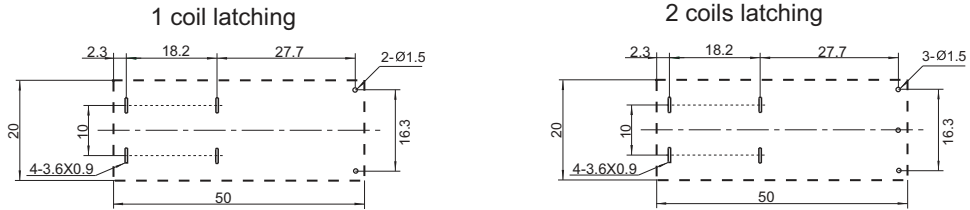

- Remark: 1) In case of no tolerance shown in outline dimension: outline dimension $\leq 1\text{mm}$, tolerance should be $\pm 0.2\text{mm}$; outline dimension $> 1\text{mm}$ and $\leq 5\text{mm}$, tolerance should be $\pm 0.3\text{mm}$; outline dimension $> 5\text{mm}$, tolerance should be $\pm 0.4\text{mm}$.
 2) The tolerance without indicating for PCB layout is always $\pm 0.1\text{mm}$.
 3) The width of the gridding is 2.52mm.

CHARACTERISTIC CURVES

SET \ RESET TIME AND VOLTAGE CURVE

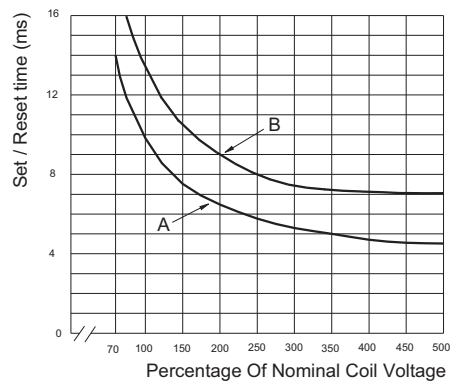

- Notes:**
 Curve B: max value
 Curve A: typical value

Notice

- Relay is on the "reset" or "set" status when being released from stock, with the consideration of shock risen from transit and relay mounting, relay would be changed to "set" or "reset" status, therefore, when application (connecting the power supply), please reset the relay to "set" or "reset" status on request.
- In order to maintain "set" or "reset" status, energized voltage to coil should reach the rated voltage, impulse width should be more than 150 ms. Do not energize voltage to "set" coil and "reset" coil simultaneously. And also long energized time (more than 1 min) should be avoided.
- Keep the product away from strong magnetic field during transportation, storage and application, to avoid change of set/reset voltage.

Disclaimer

The specification is for reference only. See to "Terminology and Guidelines" for more information. Specifications subject to change without notice. We could not evaluate all the performance and all the parameters for every possible application. Thus the user should be in a right position to choose the suitable product for their own application. If there is any query, please contact Hongfa for the technical service. However, it is the user's responsibility to determine which product should be used only.

HF37F

MINIATURE HIGH POWER RELAY



File No.:E134517



File No.:40025378



File No.:CQC13002102287



Features

- 30A switching capability
- 70A withstands inrush current
- TV-15 (at 120VAC) available
- 1 Form A configuration
- Environmental friendly product (RoHS compliant)
- Outline Dimensions: (35.2 x 32.2 x 24.0) mm

CONTACT DATA

Contact arrangement	1A
Contact resistance	100mΩ max.(at 1A 6VDC)
Contact material	AgSnO ₂ , AgCdO
Contact rating (Res. load)	30A 250VAC
Max. switching voltage	277VAC
Max. switching current	30A
Max. switching power	7500VA
Mechanical endurance	5 x 10 ⁶ OPS
Electrical endurance	1HT, 1H type: 6 x 10 ³ OPS (30A 250VAC, Resistive load, at 40°C, 1s on 9s off) 1H type: 5 x 10 ⁴ OPS (23A cosφ=1 250VAC, Resistive load, at 70°C, 1.5s on 1.5s off)

CHARACTERISTICS

Insulation resistance	1000MΩ (at 500VDC)	
Dielectric strength	Between coil & contacts	4000VAC 1min
	Between open contacts	1200VAC 1min
Operate time (at nomi. volt.)	20ms max.	
Release time (at nomi. volt.)	5ms max.	
Shock resistance	Functional	196m/s ²
	Destructive	980m/s ²
Vibration resistance	10Hz to 55Hz 1.5mm DA	
Ambient temperature	-40°C to 70°C	
Humidity	5% to 85% RH	
Termination	QC	
Unit weight	Approx. 55g	
Construction	Dust protected	

- Notes:** 1) The data shown above are initial values.
2) Please find coil temperature curve in the characteristic curves below.
3) UL insulation system: Class A

COIL

Coil power	Approx. 1.2W
------------	--------------

COIL DATA

at 23°C

Nominal Voltage VDC	Pick-up Voltage VDC max.	Drop-out Voltage VDC min.	Max. Voltage VDC *	Coil Resistance Ω
5	3.50	0.50	6.0	20.8 x (1±10%)
6	4.20	0.60	7.2	30 x (1±10%)
9	6.30	0.90	10.8	67.5 x (1±10%)
12	8.40	1.20	14.4	120 x (1±10%)
24	16.8	2.40	28.8	480 x (1±10%)
48	33.6	4.80	57.6	1920 x (1±10%)
60	42.0	6.00	72.0	3000 x (1±10%)

Notes: *Maximum voltage refers to the maximum voltage which relay coil could endure in a short period of time.

SAFETY APPROVAL RATINGS

UL/CUL	AgSnO ₂	30A 250VAC 2HP 125VAC/250VAC TV-15 120VAC
	AgCdO	30A 250VAC 2HP 125VAC/250VAC TV-15 120VAC
VDE	AgCdO	23A 250VAC at 70°C

- Notes:** 1) All values unspecified are at room temperature.
2) Only typical loads are listed above. Other load specifications can be available upon request.



HONGFA RELAY

ISO9001, ISO/TS16949, ISO14001, OHSAS18001, IECQ QC 080000 CERTIFIED

ORDERING INFORMATION

Type	HF37F / 012 -1H T (XXX)		
Coil voltage	5, 6, 9, 12, 24, 48, 60VDC		
Contact arrangement	1H: 1 Form A		
Contact material	T: AgSnO ₂ Nil: AgCdO		
Special code ²⁾	XXX: Customer special requirement	Nil: Standard	

Notes: 1) The terminal for HF37F is QC type. Please don't weld directly on terminal.
 2) The customer special requirement express as special code after evaluating by Hongfa.

OUTLINE DIMENSIONS, WIRING DIAGRAM AND PC BOARD LAYOUT

Unit: mm

Outline Dimensions

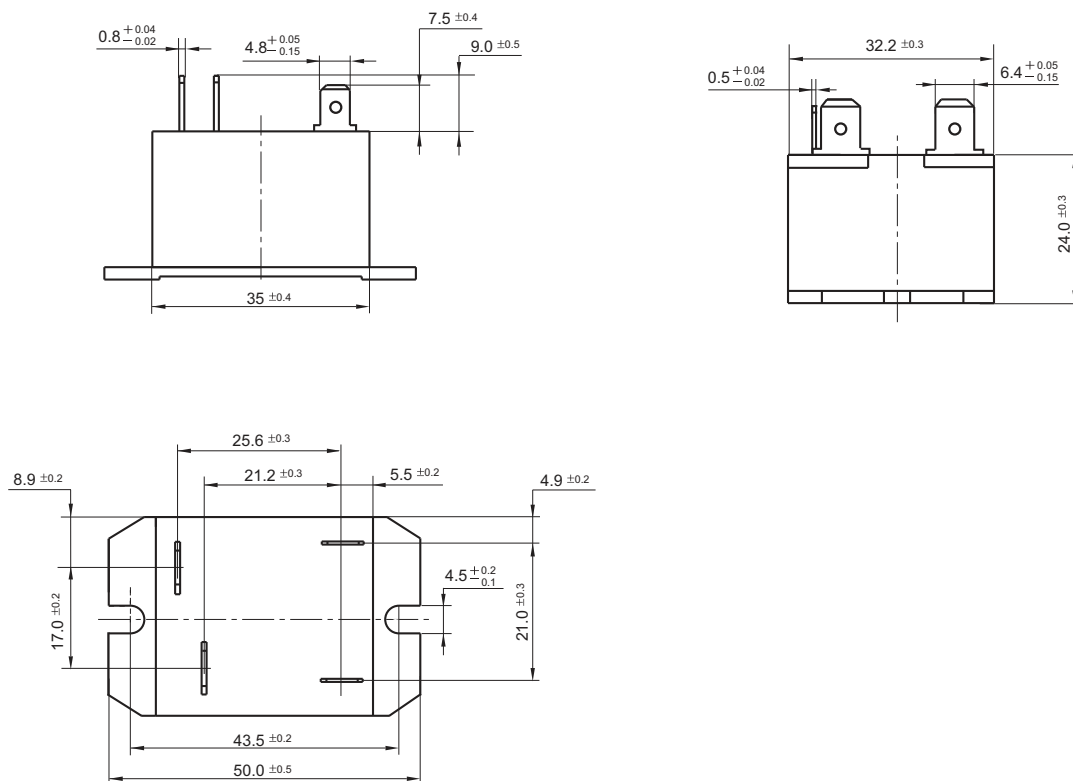

OUTLINE DIMENSIONS, WIRING DIAGRAM AND PC BOARD LAYOUT

Unit: mm

Wiring Diagram (Top view)

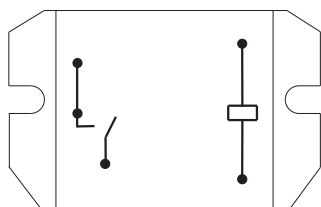

Mounting holes

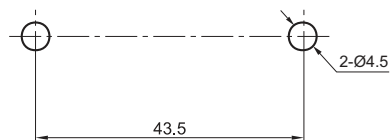

Remark: 1) In case of no tolerance shown in outline dimension: outline dimension $\leq 1\text{mm}$, tolerance should be $\pm 0.2\text{mm}$; outline dimension $> 1\text{mm}$ and $\leq 5\text{mm}$, tolerance should be $\pm 0.3\text{mm}$; outline dimension $> 5\text{mm}$, tolerance should be $\pm 0.4\text{mm}$.
2) The tolerance without indicating for PCB layout is always $\pm 0.1\text{mm}$.

CHARACTERISTIC CURVES

MAXIMUM SWITCHING POWER

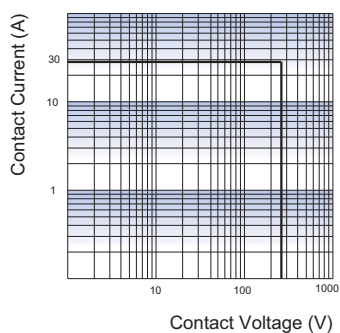

ENDURANCE CURVE

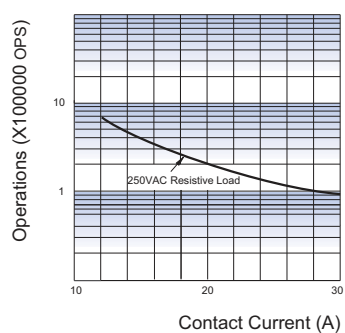

COIL TEMPERATURE RISE

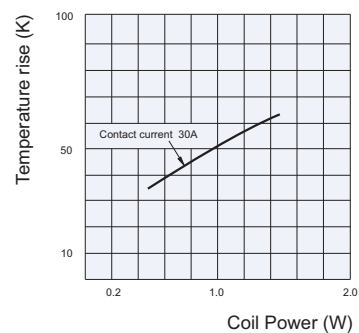

Notes:

- 1) Curve: 1HT type (or 1H type)
- 2) Test conditions: at 70°C , 1s on 9s off.

Disclaimer

The specification is for reference only. See to "Terminology and Guidelines" for more information. Specifications subject to change without notice. We could not evaluate all the performance and all the parameters for every possible application. Thus the user should be in a right position to choose the suitable product for their own application. If there is any query, please contact Hongfa for the technical service. However, it is the user's responsibility to determine which product should be used only.

HF165FD

MINIATURE HIGH POWER RELAY



File No.: E134517



File No.: 40043143



File No.: CQC15002130956



Features

- 30A switching capability
- Breakdown voltage (between contact and coil): 4kV
- Creepage distance: 5.5mm
- Plastic sealed and flux proofed types available
- Product in accordance to IEC 60335-1 available
- UL insulation system: Class F
- Environmental friendly product (RoHS compliant)
- Outline Dimensions: (32.2 x 27.5x 20.4) mm

CONTACT DATA

Contact arrangement	1A	1B	1C	
Contact resistance	100mΩ max. (at 1A 6VDC)			
Contact material	AgSnO ₂			
Contact rating (Res. load)	30A 277VAC	15A 277VAC	20A 277VAC	10A 277VAC
Max. switching voltage	277VAC			
Max. switching current	30A	30A	30A	15A
Max. switching power	8310VA	8310VA	8310VA	4155VA
Mechanical endurance	1 x 10 ⁷ OPS			
Electrical endurance ¹⁾	1 x 10 ⁵ OPS (NO: 30A 277VAC, Resistive load, Room temp., 1s on 9s off)			

Notes: 1) For plastic sealed type, the venting-hole should be opened in electrical endurance test.

CHARACTERISTICS

Insulation resistance	1000MΩ (at 500VDC)	
Dielectric strength	Between open contacts	1500VAC 1min
	Between coil & contacts	2500VAC 1min(Standard) 4000VAC 1min(V Type)
Surge voltage	6kV (1.2/50μs)	
Operate time (at nomi. volt.)	15ms max.	
Release time (at nomi. volt.)	10ms max.	
Shock resistance	Functional	98m/s ²
	Destructive	980m/s ²
Vibration resistance	10Hz to 55Hz 1.5mm DA	
Humidity	5% to 85% RH	
Ambient temperature	-40°C to 85°C	
Termination	PCB	
Unit weight	Approx. 25g	
Construction	Plastic sealed Flux proofed	

Notes: 1) The data shown above are initial values.

COIL

Coil power Approx. 900mW

COIL DATA

at 23°C

Nominal Voltage VDC	Pick-up Voltage VDC max.	Drop-out Voltage VDC min.	Max. Voltage VDC ¹⁾	Coil Resistance Ω
5	3.75	0.5	6.5	27 x (1±10%)
6	4.50	0.6	7.8	40 x (1±10%)
9	6.75	0.9	11.7	97 x (1±10%)
12	9.00	1.2	15.6	155 x (1±10%)
15	11.25	1.5	19.5	256 x (1±10%)
18	13.50	1.8	23.4	380 x (1±10%)
24	18.00	2.4	31.2	660 x (1±10%)
48 ²⁾	36.00	4.8	62.4	2560 x (1±10%)
70 ²⁾	52.50	7.0	91.0	5500 x (1±10%)
110 ²⁾	82.50	11.0	143.0	13450 x (1±10%)

Notes: 1) Maximum voltage refers to the maximum voltage which relay coil could endure in a short period of time.

2) For products with rated voltage ≥ 48V, measures should be taken to prevent coil overvoltage in order to protect coil in test and application (eg. Connect diodes in parallel).

SAFETY APPROVAL RATINGS

UL/CUL	NO	30A 277VAC at 85°C 20A 277VAC at 105°C 2HP 240VAC/1HP 120VAC at 40°C 96LRA 30FLA 277VAC at 40°C TV-8 125VAC at 40°C
		VDE
CO	30A 250VAC at 60°C 20A 250VAC at 85°C 15A 250VAC at 85°C 20A/10A 250VAC at 85°C	

Notes: 1) All values unspecified are at room temperature.

2) Only typical loads are listed above. Other load specifications can be available upon request.



HONGFA RELAY

ISO9001、ISO/TS16949、ISO14001、OHSAS18001、IECQ QC 080000 CERTIFIED

ORDERING INFORMATION

Type	HF165FD /12 -H Y1 S T F V (XXX)						
Coil voltage	5, 6, 9, 12, 15, 18, 24, 48, 70, 110						
Contact arrangement	H: 1 Form A D: 1 Form B Z: 1 Form C						
Termination	Y1: Without Pin NO.6			Y2: With Pin NO.6			
Construction ¹⁾	S: Plastic sealed			Nil: Flux proofed			
Contact material	T: AgSnO ₂						
Insulation standard	F: Class F						
Dielectric strength standard	Nil: Standard product(2500VAC Between coil & contacts)						
	V : High Dielectric strength(Only for Y1 Termination) (4000VAC Between coil & contacts)						
Special code ²⁾	XXX: Customer special requirement			Nil: Standard			

Notes: 1) We recommend flux proofed types for a clean environment (free from contaminations like H₂S, SO₂, NO₂, dust, etc.). We suggest to choose plastic sealed types and validate it in real application for an unclean environment (with contaminations like H₂S, SO₂, NO₂, dust, etc.).
2) The customer special requirement express as special code after evaluating by Hongfa. e.g.(335) stands for product in accordance to IEC 60335-1 (GWT).

OUTLINE DIMENSIONS, WIRING DIAGRAM AND PCB BOARD LAYOUT

Unit: mm

Outline Dimensions

PCB Layout (Bottom view)

HF165FD/□□-HY1□□□□

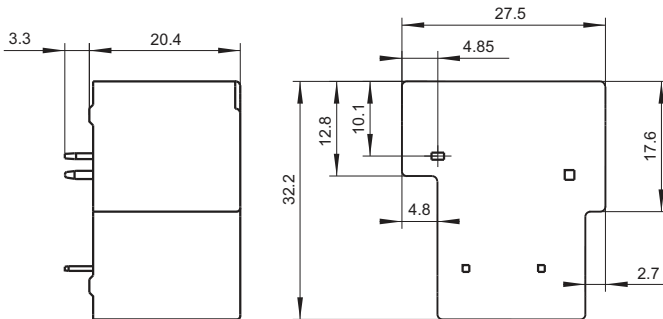

HF165FD/□□-HY1□□□□

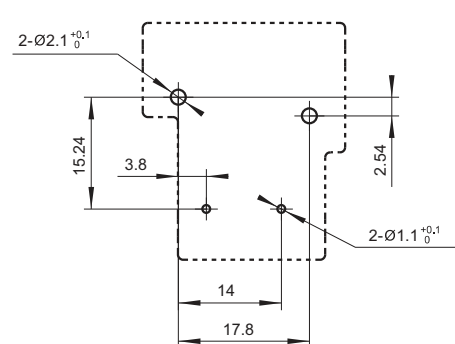

HF165FD/□□-HY2□□□□

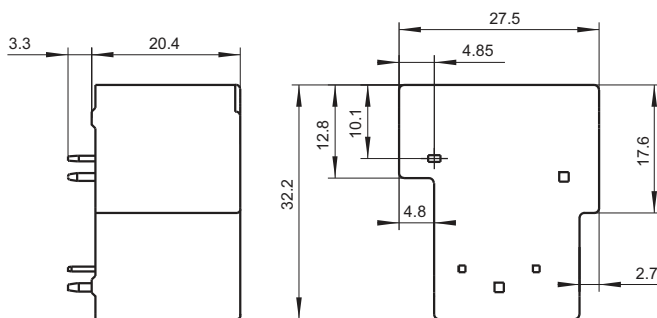

HF165FD/□□-HY2□□□□

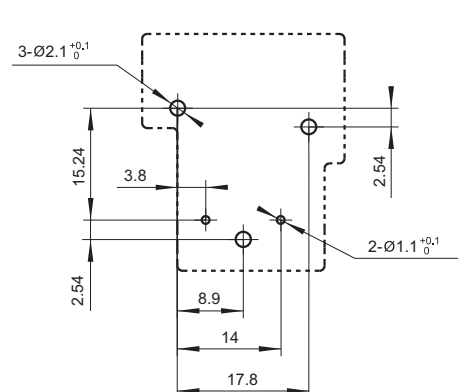

OUTLINE DIMENSIONS, WIRING DIAGRAM AND PC BOARD LAYOUT

Unit: mm

Outline Dimensions

HF165FD/□□-DY1□□□□

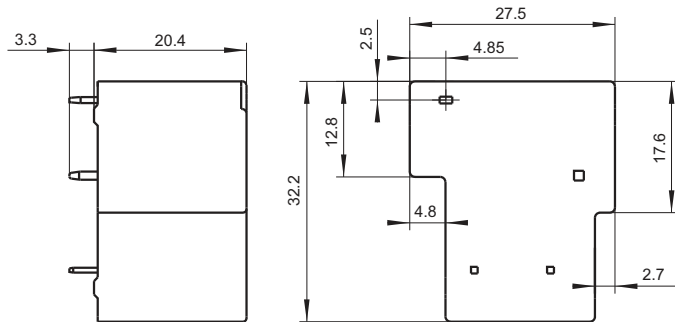

PCB Layout (Bottom view)

HF165FD/□□-DY1□□□□

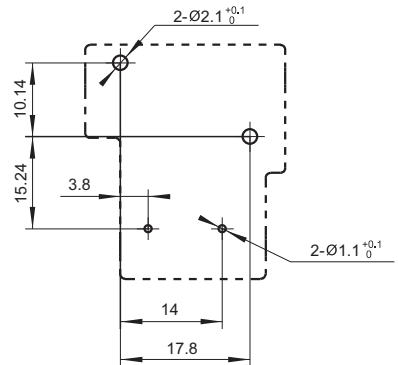

HF165FD/□□-DY2□□□□

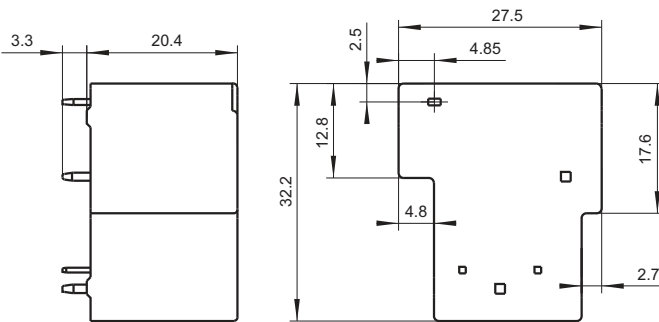

HF165FD/□□-DY2□□□□

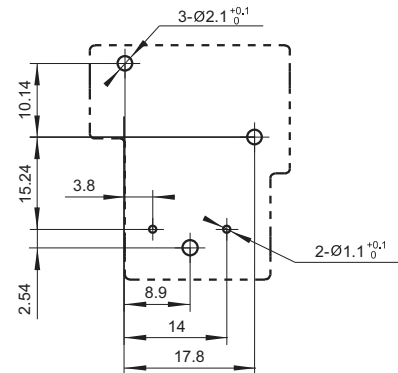

HF165FD/□□-ZY1□□□□

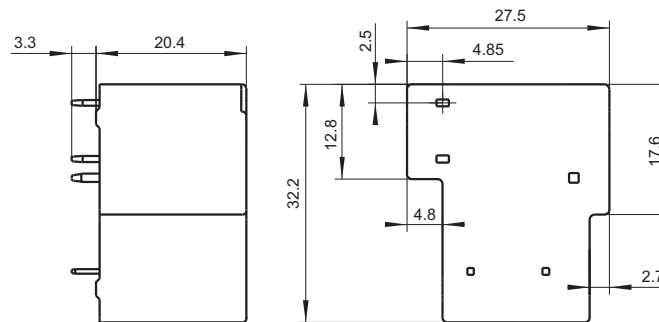

HF165FD/□□-ZY1□□□□

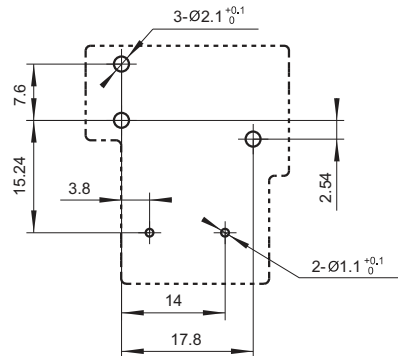

HF165FD/□□-ZY2□□□□

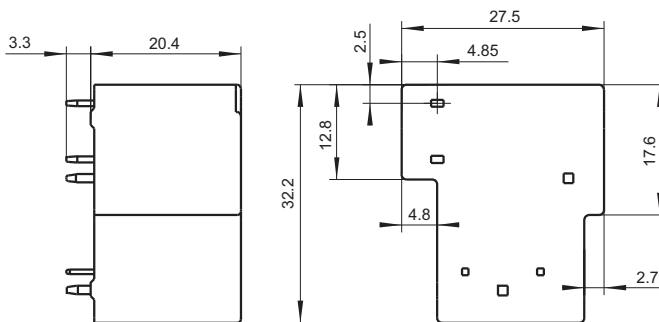

HF165FD/□□-ZY2□□□□

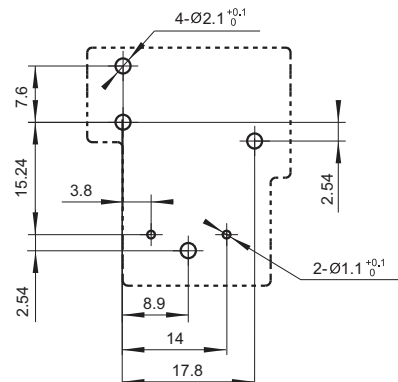

OUTLINE DIMENSIONS, WIRING DIAGRAM AND PC BOARD LAYOUT

Unit: mm

Wiring Diagram (Bottom view)

HF165FD/□□-HY1□□□□

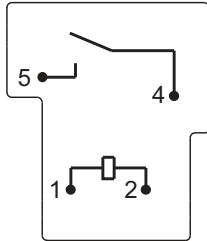

HF165FD/□□-DY1□□□□

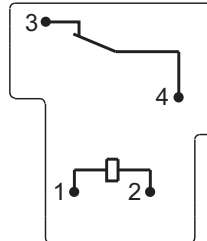

HF165FD/□□-ZY1□□□□

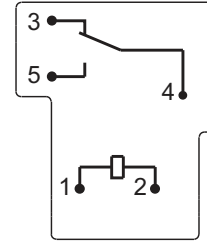

HF165FD/□□-HY2□□□□

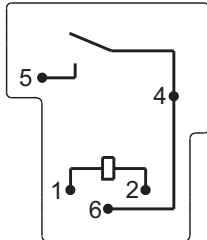

HF165FD/□□-DY2□□□□

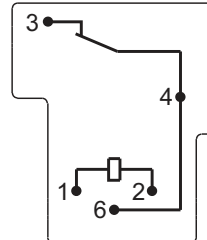

HF165FD/□□-ZY2□□□□

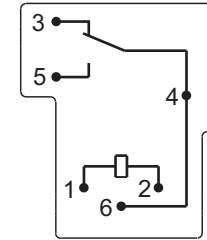

- Remark: 1) In case of no tolerance shown in outline dimension: outline dimension $\leq 1\text{mm}$, tolerance should be $\pm 0.2\text{mm}$; outline dimension $> 1\text{mm}$ and $\leq 5\text{mm}$, tolerance should be $\pm 0.3\text{mm}$; outline dimension $> 5\text{mm}$, tolerance should be $\pm 0.4\text{mm}$.
 2) The tolerance without indicating for PCB layout is always $\pm 0.1\text{mm}$.
 3) The width of the gridding is 2.5mm.

CHARACTERISTIC CURVES

MAXIMUM SWITCHING POWER

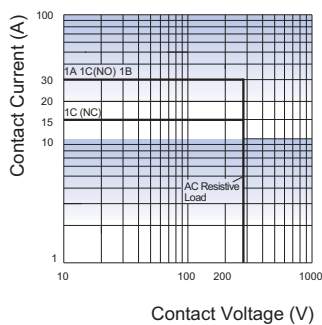

ENDURANCE CURVE

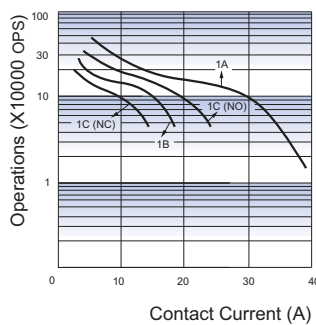

COIL OPERATING RANGE (AC)

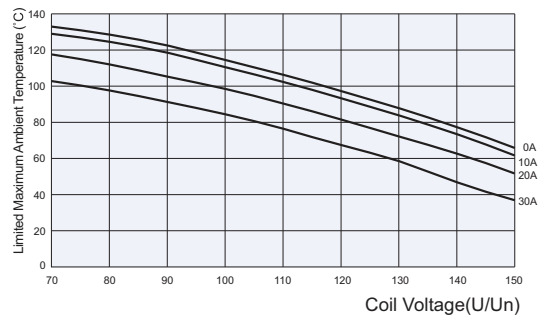

Test conditions:
 Flux proofed, Room temp.,
 1s on 9s off.

Disclaimer

The specification is for reference only. See to "Terminology and Guidelines" for more information. Specifications subject to change without notice. We could not evaluate all the performance and all the parameters for every possible application. Thus the user should be in a right position to choose the suitable product for their own application. If there is any query, please contact Hongfa for the technical service. However, it is the user's responsibility to determine which product should be used only.

HF165FD-G

MINIATURE HIGH POWER RELAY



File No.: E134517



File No.: 40043143



File No.: CQC15002130956



Features

- 40A switching capability
- Breakdown voltage (between contact and coil): 4kV
- Creepage distance: 5.5mm
- Plastic sealed and flux proofed types available
- Product in accordance to IEC 60335-1 available
- UL insulation system: Class F
- Environmental friendly product (RoHS compliant)
- Outline Dimensions: (32.2 x 27.5x 20.4) mm

CONTACT DATA

Contact arrangement	1A
Contact resistance	100mΩ max. (at 1A 6VDC)
Contact material	AgSnO ₂
Contact rating (Res. load)	40A 277VAC
Max. switching voltage	277VAC
Max. switching current	40A
Max. continuous current ¹⁾	30A
Max. switching power	11080VA
Mechanical endurance	1 x 10 ⁷ OPS
Electrical endurance ²⁾	1 x 10 ⁴ OPS (NO: 40A 277VAC, Resistive load, Room temp., 1s on 9s off, Flux proofed)

Notes: 1) Long time current-carrying under 40A condition is prohibited.
2) For plastic sealed type, the venting-hole should be opened in electrical endurance test.

CHARACTERISTICS

Insulation resistance	1000MΩ (at 500VDC)
Dielectric strength	Between open contacts 1500VAC 1min
	Between coil & contacts 2500VAC 1min(Standard) 4000VAC 1min(V Type)
Surge voltage	6kV (1.2/50μs)
Operate time (at nomi. volt.)	15ms max.
Release time (at nomi. volt.)	10ms max.
Shock resistance	Functional 98m/s ²
	Destructive 980m/s ²
Vibration resistance	10Hz to 55Hz 1.5mm DA
Humidity	5% to 85% RH
Ambient temperature	-40°C to 85°C
Termination	PCB
Unit weight	Approx. 25g
Construction ²⁾	Plastic sealed Flux proofed

Notes: 1) The data shown above are initial values.

COIL

Coil power Approx. 900mW

COIL DATA

at 23°C

Nominal Voltage VDC	Pick-up Voltage VDC max.	Drop-out Voltage VDC min.	Max. Voltage VDC ¹⁾	Coil Resistance Ω
5	3.75	0.5	6.5	27 x (1±10%)
6	4.50	0.6	7.8	40 x (1±10%)
9	6.75	0.9	11.7	97 x (1±10%)
12	9.00	1.2	15.6	155 x (1±10%)
15	11.25	1.5	19.5	256 x (1±10%)
18	13.50	1.8	23.4	380 x (1±10%)
24	18.00	2.4	31.2	660 x (1±10%)
48 ²⁾	36.00	4.8	62.4	2560 x (1±10%)
70 ²⁾	52.50	7.0	91.0	5500 x (1±10%)
110 ²⁾	82.50	11.0	143.0	13450 x (1±10%)

Notes: 1) Maximum voltage refers to the maximum voltage which relay coil could endure in a short period of time.

2) For products with rated voltage ≥ 48V, measures should be taken to prevent coil overvoltage in order to protect coil in test and application (eg. Connect diodes in parallel).

SAFETY APPROVAL RATINGS

UL/CUL	NO	40A 277VAC 40°C
		30A 277VAC 85°C
VDE	NO	2HP 240VAC/1HP 120VAC 40°C
		96LRA, 30FLA 40°C
		TV-8 125VAC 40°C
		40A 250VAC

Notes: 1) All values unspecified are at room temperature.

2) Only typical loads are listed above. Other load specifications can be available upon request.



HONGFA RELAY

ISO9001、ISO/TS16949、ISO14001、OHSAS18001、IECQ QC 080000 CERTIFIED

ORDERING INFORMATION

Type	HF165FD-G /12 -H Y1 S T F V (XXX)					
Coil voltage	5, 6, 9, 12, 15, 18, 24, 48, 70, 110					
Contact arrangement	H: 1 Form A					
Termination	Y1: Without Pin NO.6		Y2: With Pin NO.6			
Construction ¹⁾	S: Plastic sealed		Nil: Flux proofed			
Contact material	T: AgSnO ₂					
Insulation standard	F: Class F					
Dielectric strength standard	Nil: Standard product(2500VAC Between coil & contacts)					
	V : High Dielectric strength(Only for Y1 Termination) (4000VAC Between coil & contacts)					
Special code ²⁾	XXX: Customer special requirement			Nil: Standard		

Notes: 1) We recommend flux proofed types for a clean environment (free from contaminations like H₂S, SO₂, NO₂, dust, etc.). We suggest to choose plastic sealed types and validate it in real application for an unclean environment (with contaminations like H₂S, SO₂, NO₂, dust, etc.).
2) The customer special requirement express as special code after evaluating by Hongfa. e.g.(335) stands for product in accordance to IEC 60335-1 (GWT).

OUTLINE DIMENSIONS, WIRING DIAGRAM AND PC BOARD LAYOUT

Unit: mm

Outline Dimensions

HF165FD-G/□□-HY1□□□□

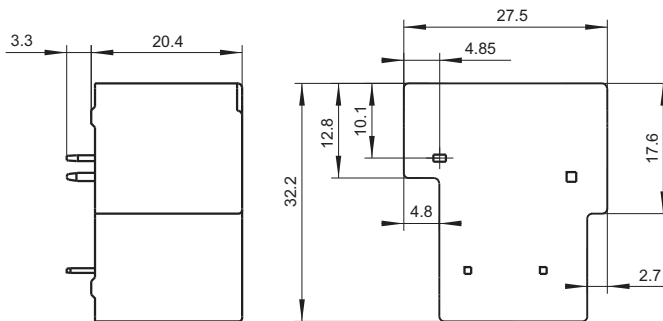

PCB Layout (Bottom view)

HF165FD-G/□□-HY1□□□□

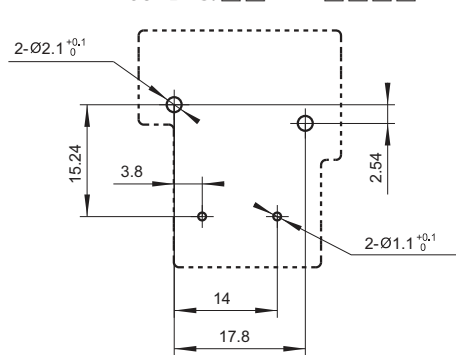

HF165FD-G/□□-HY2□□□□

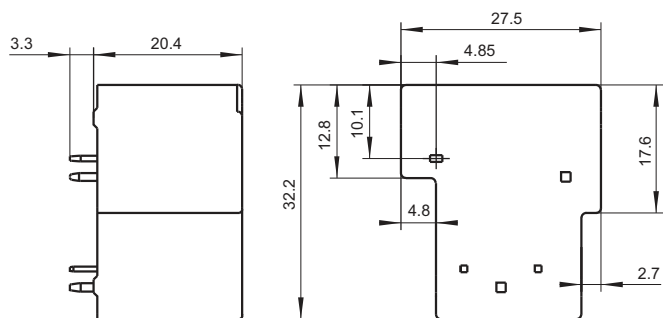

HF165FD-G/□□-HY2□□□□

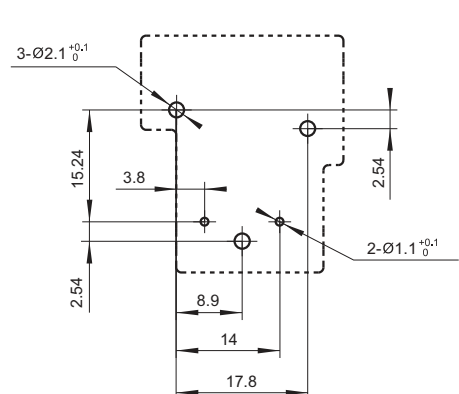

Wiring Diagram (Bottom view)

HF165FD-G/□□-HY1□□□□

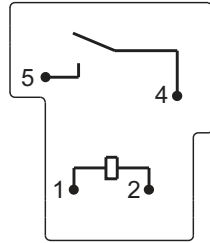

HF165FD-G/□□-HY2□□□□

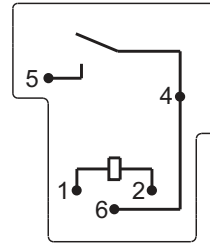

- Remark: 1) In case of no tolerance shown in outline dimension: outline dimension $\leq 1\text{mm}$, tolerance should be $\pm 0.2\text{mm}$; outline dimension $> 1\text{mm}$ and $\leq 5\text{mm}$, tolerance should be $\pm 0.3\text{mm}$; outline dimension $> 5\text{mm}$, tolerance should be $\pm 0.4\text{mm}$.
 2) The tolerance without indicating for PCB layout is always $\pm 0.1\text{mm}$.
 3) The width of the gridding is 2.5mm.

CHARACTERISTIC CURVES

MAXIMUM SWITCHING POWER

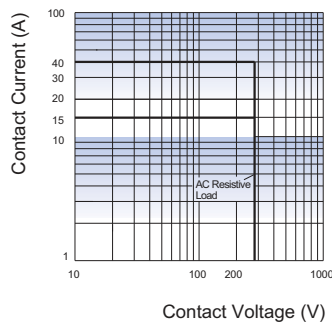

Disclaimer

The specification is for reference only. See to "Terminology and Guidelines" for more information. Specifications subject to change without notice. We could not evaluate all the performance and all the parameters for every possible application. Thus the user should be in a right position to choose the suitable product for their own application. If there is any query, please contact Hongfa for the technical service. However, it is the user's responsibility to determine which product should be used only.



File No:E134517



File No:40037289



Features

- 35A switching capitable.
- Applicable to inverter used for photovoltaic power generation systems.
- Ideal for UPS.
- 1.8mm contact gap(compliant to European Photovoltaic Standard VDE0126).
- Product in accordance to IEC 60335 available.
- Low coil holding voltage contributes to saving energy of equipment.
- UL insulation system: class F.
- Environmental friendly product (RoHS compliant).
- Outline Dimensions: (32.2 x 27.4 x 19.4) mm.

CONTACT DATA

Contact arrangement	1A
Voltage drop	Typ.: 15mV(at 10A) Max.: 100mV(at 10A)
Contact material	AgSnO ₂
Contact rating (Res. load)	Resistive: 35A 250VAC Inductive: 35A 277VAC (cosφ=0.8) 1s:9s
Max. switching voltage	277VAC
Max. switching current ¹⁾	35A
Max. switching power	9695VA
Mechanical endurance	1 x 10 ⁶ OPS
Electrical endurance	3 x 10 ⁴ OPS (35A 250VAC, Resistive load, at 85°C, 1s on 9s off)

Notes: 1)The relay connections and wiring have to be designed with an adequate cross sections to ensure the current flow and heat dissipation.

CHARACTERISTICS

Insulation resistance	1000MΩ (at 500VDC)
Dielectric strength	Between coil & contacts 4000VAC 1min
	Between open contacts 2500VAC 1min
Surge voltage (between coil & contacts)	6kV (1.2/50μs)
Operate time (at nomi. volt.)	15ms max.
Release time (at nomi. volt.)	10ms max.
Temperature rise (at nomi. volt.)	70K max.(Contact load current 35A, 50% of rated voltage excitation, at 85°C)
Shock resistance	Functional 98m/s ²
	Destructive 980m/s ²
Vibration resistance	10Hz to 55Hz 1.5mm DA
Ambient temperature	-40°C to 85°C (Apply holding voltage to coil)
Humidity	5% to 85% RH
Termination	PCB
Unit weight	Approx.36g
Construction	Flux proofed

Notes: The data shown above are initial values.



HONGFA RELAY

ISO9001、ISO/TS16949、ISO14001、OHSAS18001、IECQ QC 080000 CERTIFIED

COIL

Coil power	Approx.2.25W
Holding voltage	40% to 110%U _N (at 23°C) 50% to 70%U _N (at 85°C)

Notes: 1)The coil holding voltage is the voltage applied to coil 100ms after the rated voltage.
2)To avoid overheating and burning, the coil can not be consistently applied to with voltage larger than maximum holding voltage.

COIL DATA

at 23°C

Nominal Voltage VDC ¹⁾	Pick-up Voltage VDC max.	Drop-out Voltage VDC min.	Max. Voltage VDC *	Coil Resistance Ω
5	3.75	0.35	5.5	11.1 x (1±10%)
12	9	0.84	13.2	64 x (1±10%)
24	18	1.68	26.4	256 x (1±10%)
48	36	3.36	52.8	1024 x (1±10%)

Notes: *Maximum voltage refers to the maximum voltage which relay coil could endure in a short period of time.

SAFETY APPROVAL RATINGS

UL/CUL	35A 277VAC/250VAC general use 3 x 10 ⁴ OPS at 85°C
VDE	35A 250VAC 3 x 10 ⁴ OPS at 85°C

Notes: 1) All values unspecified are at room temperature.
2) Only typical loads are listed above. Other load specifications can be available upon request.

ORDERING INFORMATION

Type	HF165F /	12	-H	T	(XXX)
Coil voltage	5, 12, 24, 48VDC				
Contact arrangement	H:1 Form A				
Contact material	T: AgSnO ₂				
Special code ³⁾	XXX: Customer special requirement		Nil: Standard		

Notes: 1) Water cleaning or surface process is not suggested after the flux-proofed relays are assembled on PCB.

2) Flux-proofed relays can not be used in the environment with pollutants like H₂S, SO₂, NO₂, dust, etc.

3) The customer special requirement express as special code after evaluating by Hongfa. e.g.(335) stands for product in accordance to IEC 60335-1 (GWT).

OUTLINE DIMENSIONS, WIRING DIAGRAM AND PC BOARD LAYOUT

Unit: mm

Outline Dimensions

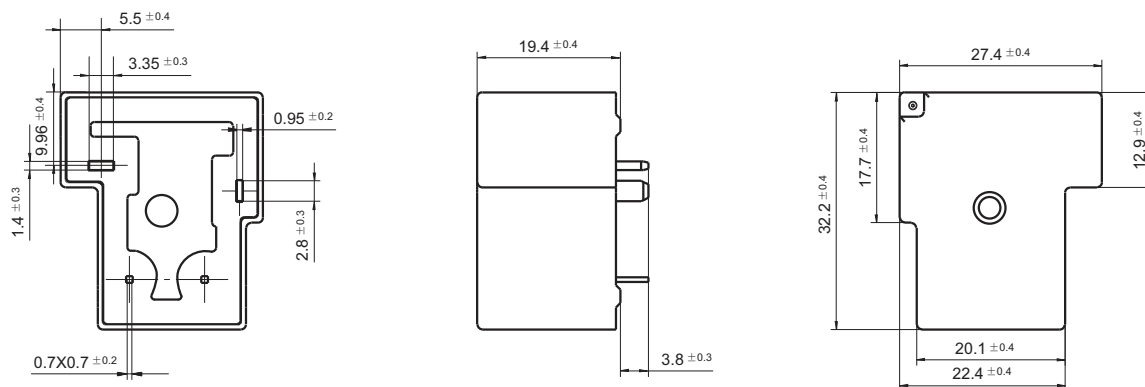

PCB Layout (Bottom view)

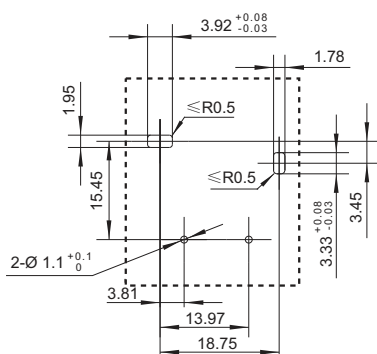

Wiring Diagram

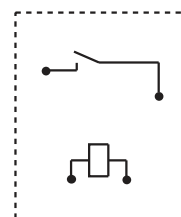

- Notes: 1) In case of no tolerance shown in outline dimension: outline dimension ≤ 1 mm, tolerance should be ± 0.2 mm; outline dimension > 1 mm and ≤ 5 mm, tolerance should be ± 0.3 mm; outline dimension > 5 mm, tolerance should be ± 0.4 mm.
2) The tolerance without indicating for PCB layout is always ± 0.1 mm.

CHARACTERISTIC CURVES

MAXIMUM SWITCHING POWER

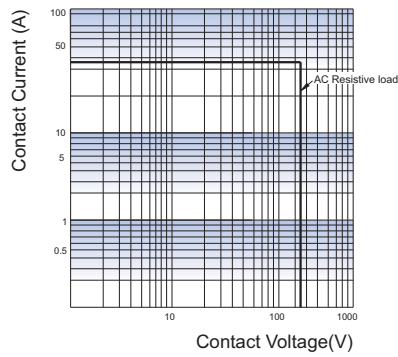

ENDURANCE CURVE

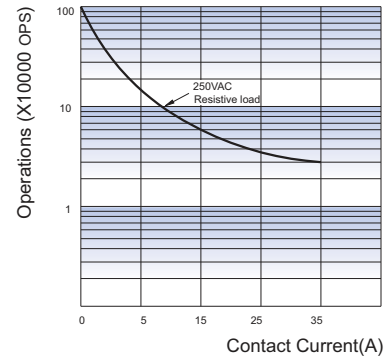

Test conditions:

Resistive load, 250VAC,

Flux proofed, at 85°C, 1s on 9s off

Disclaimer

The specification is for reference only. See to "Terminology and Guidelines" for more information. Specifications subject to change without notice. We could not evaluate all the performance and all the parameters for every possible application. Thus the user should be in a right position to choose the suitable product for their own application. If there is any query, please contact Hongfa for the technical service. However, it is the user's responsibility to determine which product should be used only.

HF105F-1

MINIATURE HIGH POWER RELAY



File No.:E134517



File No.:40025518 (DC Type)



File No.:CQC09002031229(Ningbo Factory, DC Type)
 CQC12002071130(Ningbo Factory, AC Type)
 CQC16002140270(Xiamen Factory, DC Type)



Features

- 40A switching capability
- 4kV dielectric strength (between coil and contacts)
- Heavy load up to 7200VA
- PCB coil terminals, ideal for heavy duty load
- Unenclosed, Plastic sealed and dust protected types available
- UL insulation system: Class F available
- Environmental friendly product (RoHS compliant)
- Outline Dimensions: (32.3 x 27.1x 20.0) mm

CONTACT DATA

Contact arrangement	1A	1B	1C (NO)	1C (NC)
Contact resistance	50mΩ max. (at 1A 24VDC)			
Contact material	AgSnO ₂ , AgCdO			
Max. switching capacity	7200VA/560W	3600VA/280W	4800VA/560W	2400VA/280W
Max. switching voltage	277VAC / 28VDC			
Max. switching current	40A	15A	20A	10A
HF105F-1 rating	30A 240VAC 20A 28VDC	15A 240VAC 10A 28VDC	20A 240VAC 20A 28VDC	10A 240VAC 10A 28VDC
HF105F-1L rating	25A 240VAC 20A 28VDC	15A 240VAC 10A 28VDC	20A 240VAC 20A 28VDC	10A 240VAC 10A 28VDC
Mechanical endurance	1 x 10 ⁷ OPS			
Electrical endurance	1H type(Non-plastic sealed): 1 x 10 ⁵ OPS (28A 277VAC, Resistive load, AgCdO, Room temp., 1s on 9s off)			

CHARACTERISTICS

Insulation resistance	1000MΩ (at 500VDC)	
Dielectric strength	Between coil & contacts	2500VAC/4000VAC 1min
	Between open contacts	1500VAC 1min
Operate time (at nomi. volt.)	DC type: 15ms max.	
Release time (at nomi. volt.)	DC type: 10ms max.	
Ambient temperature	DC: -55°C to 85°C AC: -55°C to 60°C	
Shock resistance	Functional	98m/s ²
	Destructive	980m/s ²
Vibration resistance	10Hz to 55Hz 1.5mm DA	
Humidity	5% to 85% RH	
Termination	PCB	
Unit weight	Approx.36g	
Construction	Unenclosed (Only for DC coil), Plastic sealed, Dust protected	

- Notes:** 1) For plastic sealed type, the venting-hole should be opened in test.
 2) The data shown above are initial values.
 3) Please find coil temperature curve in the characteristic curves below.
 4) UL insulation system: Class F, Class B.

COIL

Coil power	DC type: Approx. 900mW; AC type: Approx. 2VA
------------	---

SAFETY APPROVAL RATINGS

UL / CUL	1 Form A	AgSnO ₂ AgCdO	30A 277VAC	
			40A 277VAC	
		AgCdO	2HP 250VAC	
			1HP 125VAC	
	1 Form B	AgCdO	30A 28VDC	
			28A 277VAC	
		277VAC(FLA=20)(LRA=60)		
		15A 277VAC		
	1 Form C	NO	AgSnO ₂ AgCdO	30A 277VAC
				2HP 250VAC
		AgCdO	1HP 125VAC	
			20A 277VAC	
20A 28VDC				
277VAC(FLA=20)(LRA=60)				
NC		AgSnO ₂ AgCdO	20A 277VAC	
			1/2HP 250VAC	
	AgCdO	1/4HP 125VAC		
		10A 277VAC		
10A 28VDC				
277VAC(FLA=10)(LRA=33)				

- Notes:** 1) All values unspecified are at room temperature.
 2) Only typical loads are listed above. Other load specifications can be available upon request.



HONGFA RELAY

ISO9001, ISO/TS16949, ISO14001, OHSAS18001, IECQ QC 080000 CERTIFIED

COIL DATA

at 23°C

DC type

Nominal Voltage VDC	Pick-up Voltage VDC max.	Drop-out Voltage VDC min.	Max. Voltage VDC *	Coil Resistance Ω
5	3.75	0.5	6.5	27 x (1±10%)
6	4.50	0.6	7.8	40 x (1±10%)
9	6.75	0.9	11.7	97 x (1±10%)
12	9.00	1.2	15.6	155 x (1±10%)
15	11.25	1.5	19.5	256 x (1±10%)
18	13.50	1.8	23.4	380 x (1±10%)
24	18.00	2.4	31.2	660 x (1±10%)
48	36.00	4.8	62.4	2560 x (1±10%)
70	52.50	7.0	91	5500 x (1±10%)
110	82.50	11	143	13450 x (1±10%)

AC type

Nominal Voltage VAC	Pick-up Voltage VAC max.	Drop-out Voltage VAC min.	Max. Voltage VDC *	Coil Resistance Ω
12	9.6	2.4	15.6	25 x (1±10%)
24	19.2	4.8	31.2	100 x (1±10%)
120	96.0	24.0	156	2500 x (1±10%)
208	166.4	41	270.4	11000 x (1±10%)
220	176	44	286	13490 x (1±10%)
240	192	48	286	13490 x (1±10%)
277	220	54	360.1	15000 x (1±10%)

- Notes:**
- 1) When requiring pick-up voltage < 80% of nominal voltage, special order allowed.
 - 2) The data shown above are initial values at 50Hz. When requiring 60Hz, special order allowed.
 - 3) *Maximum voltage refers to the maximum voltage which relay coil could endure in a short period of time.

ORDERING INFORMATION

Type	HF105F-1 / 018 D T -1H S T F (XXX)	
	HF105-1: 30A (Unenclosed, only for DC coil) HF105-1L: 25A (Unenclosed, only for DC coil) HF105F-1: 30A HF105F-1L: 25A	
Coil voltage	DC: 5VDC to 110VDC AC: 12VAC to 277VAC	
Coil voltage form	D: DC A: AC	
Termination	6: With Pin NO.6, Dielectric Strength Between Coil and Contact: 2500VAC T: Without Pin NO.6, Dielectric Strength Between Coil and Contact: 4000VAC Nil: Without Pin NO.6, Dielectric Strength Between Coil and Contact: 2500VAC	
Contact arrangement	1H: 1 Form A 1D: 1 Form B 1Z: 1 Form C	
Construction ¹⁾²⁾	S: Plastic sealed Nil: Dust protected (For HF105F-1, HF105F-1L) Unenclosed (For HF105-1, HF105-1L)	
Contact material	T: AgSnO ₂ Nil: AgCdO	
Insulation standard	F: Class F Nil: Class B	
Special code ³⁾	XXX: Customer special requirement Nil: Standard	

Notes: 1) We recommend dust protected types for a clean environment (free from contaminations like H₂S, SO₂, NO₂, dust, etc.).

We suggest to choose plastic sealed types and validate it in real application for an unclean environment (with contaminations like H₂S, SO₂, NO₂, dust, etc.).

2) Contact is recommended for suitable condition and specifications if water cleaning or surface process is involved in assembling relays on PCB.

3) The customer special requirement express as special code after evaluating by Hongfa.

OUTLINE DIMENSIONS, WIRING DIAGRAM AND PC BOARD LAYOUT

Unit: mm

HF105F-1

1 Form A

Outline Dimensions

Wiring Diagram
(Bottom view)

PCB Layout
(Bottom view)

With 6# terminal

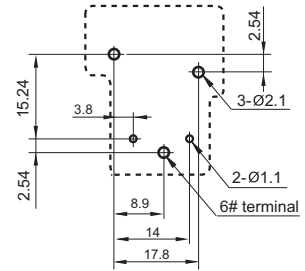
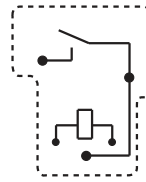
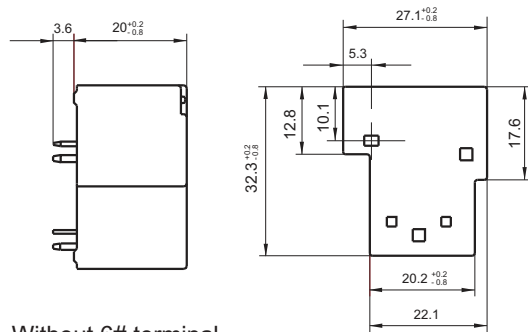

Without 6# terminal

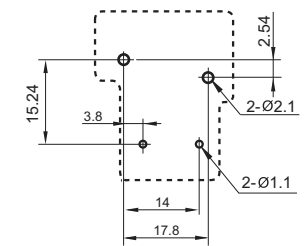
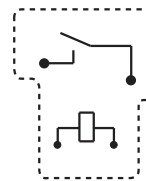
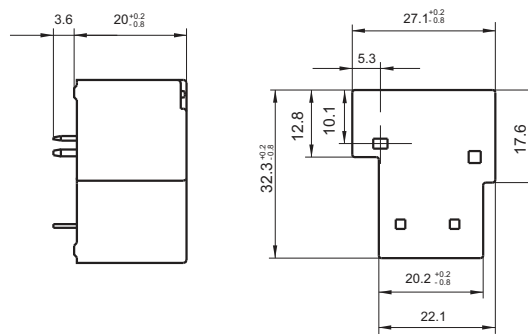

1 Form B

With 6# terminal

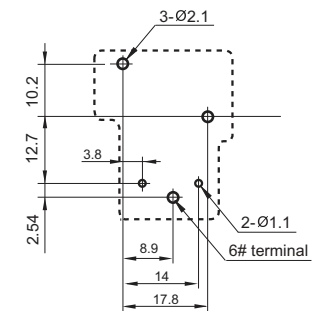
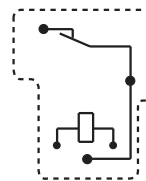
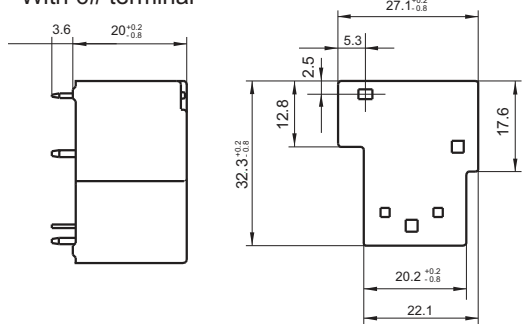

Without 6# terminal

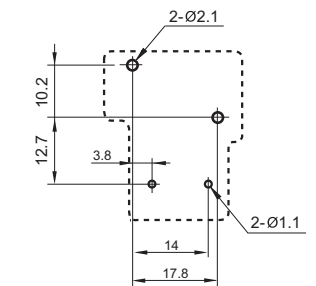
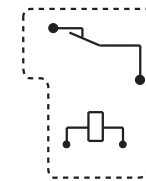
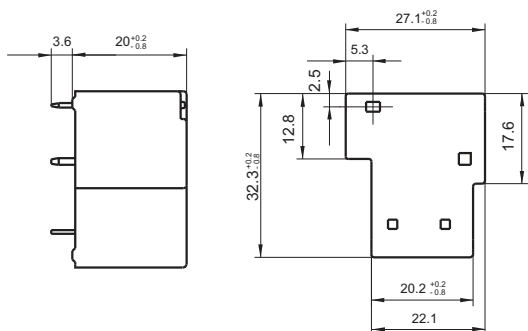

OUTLINE DIMENSIONS, WIRING DIAGRAM AND PC BOARD LAYOUT

Unit: mm

1 Form C

Outline Dimensions

Wiring Diagram (Bottom view)

PCB Layout (Bottom view)

With 6# terminal

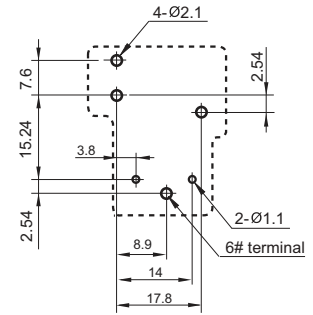
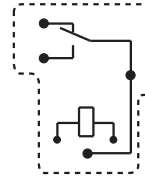
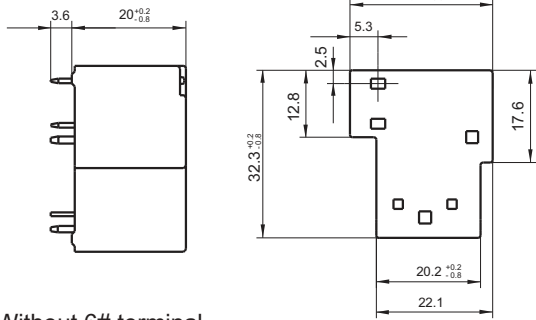

Without 6# terminal

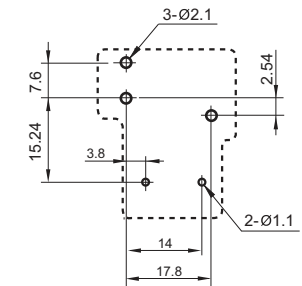
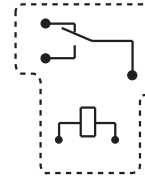
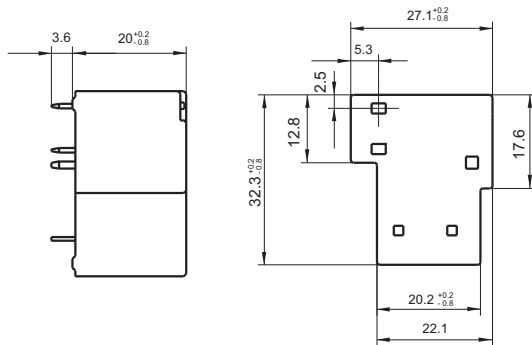

HF105-1

1 Form A

With 6# terminal

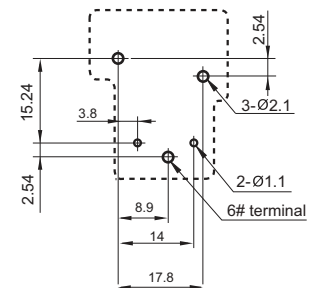
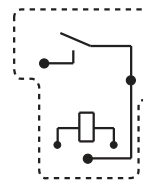
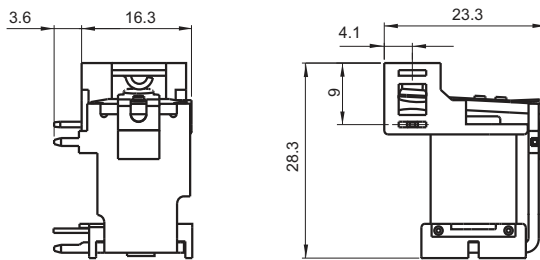

Without 6# terminal

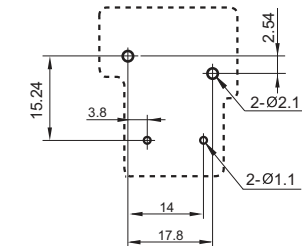
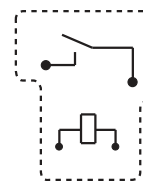
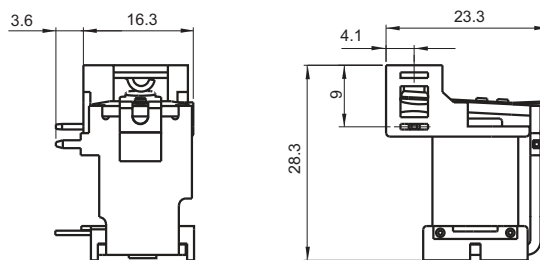

OUTLINE DIMENSIONS, WIRING DIAGRAM AND PC BOARD LAYOUT

Unit: mm

1 Form B

Outline Dimensions

With 6# terminal

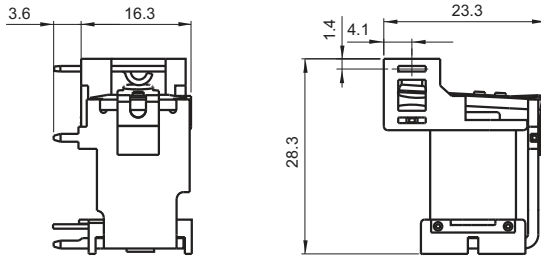

Wiring Diagram (Bottom view)

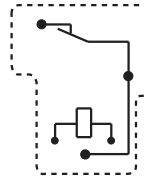

PCB Layout (Bottom view)

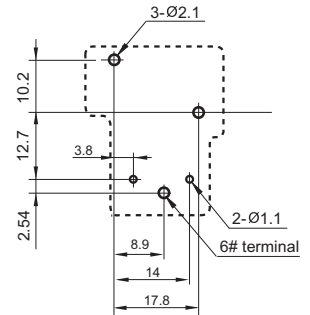

Without 6# terminal

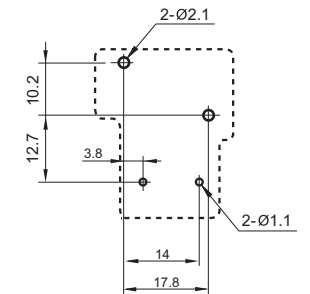
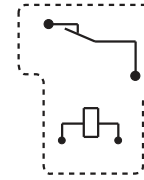
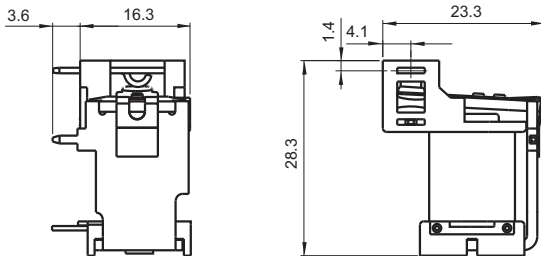

1 Form C

With 6# terminal

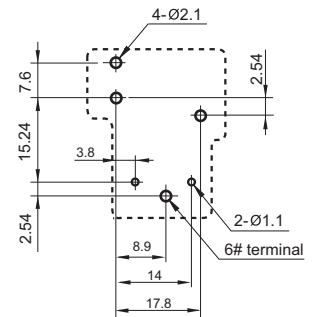
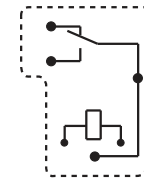
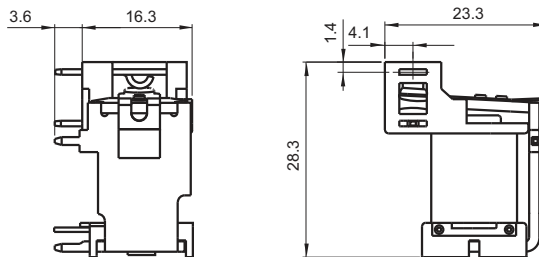

Without 6# terminal

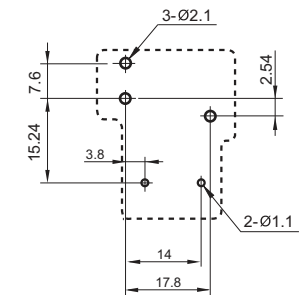
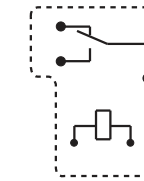
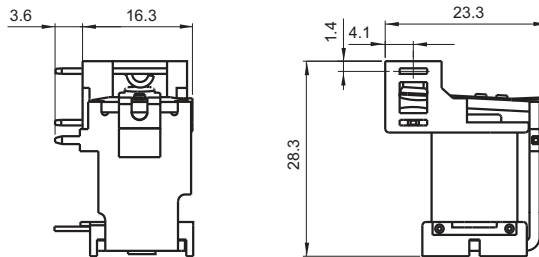

- Remark: 1) In case of no tolerance shown in outline dimension: outline dimension $\leq 1\text{mm}$, tolerance should be $\pm 0.2\text{mm}$; outline dimension $> 1\text{mm}$ and $\leq 5\text{mm}$, tolerance should be $\pm 0.3\text{mm}$; outline dimension $> 5\text{mm}$, tolerance should be $\pm 0.4\text{mm}$.
 2) The tolerance without indicating for PCB layout is always $\pm 0.1\text{mm}$.

CHARACTERISTIC CURVES

MAXIMUM SWITCHING POWER

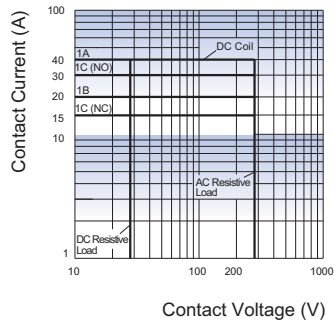

ENDURANCE CURVE

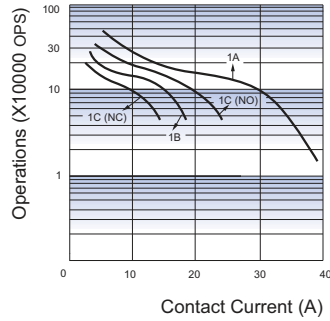

COIL TEMPERATURE RISE

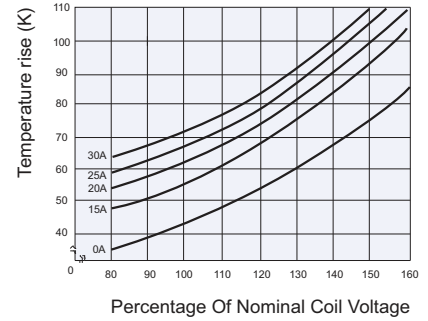

Test conditions:

Resistive load, Dust protected,
AgCdO, Room temp., 1s on 9s off.

Disclaimer

The specification is for reference only. See to "Terminology and Guidelines" for more information. Specifications subject to change without notice. We could not evaluate all the performance and all the parameters for every possible application. Thus the user should be in a right position to choose the suitable product for their own application. If there is any query, please contact Hongfa for the technical service. However, it is the user's responsibility to determine which product should be used only.

HF105F-2

MINIATURE HIGH POWER RELAY



File No.:E134517



File No.:40025518 (DC type)



File No.:CQC09002031229(DC type)



Features

- 40A switching capability
- Heavy load up to 7200VA
- PCB coil terminals, ideal for heavy duty load
- Plastic sealed and dust protected types available
- UL insulation system: Class F available
- Environmental friendly product (RoHS compliant)
- Outline Dimensions: (32.4 x 27.5 x 27.8)mm

CONTACT DATA

Contact arrangement	1A	1B	1C (NO)	1C (NC)
Contact resistance	50mΩ max.(at 1A 24VDC)			
Contact material	AgSnO ₂ , AgCdO			
Max. switching capacity	7200VA/560W	3600VA/280W	4800VA/560W	2400VA/280W
Max. switching voltage	277VAC/28VDC			
Max. switching current	40A	15A	20A	10A
HF105F-2 rating	30A 240VAC 20A 28VDC	15A 240VAC 10A 28VDC	20A 240VAC 20A 28VDC	10A 240VAC 10A 28VDC
HF105F-2L rating	25A 240VAC 20A 28VDC	15A 240VAC 10A 28VDC	20A 240VAC 20A 28VDC	10A 240VAC 10A 28VDC
Mechanical endurance	1 x 10 ⁷ OPS			
Electrical endurance	1H type(Non-plastic sealed): 1 x 10 ⁵ OPS (28A 277VAC, Resistive load, AgCdO, Room temp., 1s on 9s off)			

CHARACTERISTICS

Insulation resistance	1000MΩ (at 500VDC)	
Dielectric strength	Between coil & contacts	2500VAC 1min
	Between open contacts	1500VAC 1min
Operate time (at nomi. volt.)	DC type: 15ms max.	
Release time (at nomi. volt.)	DC type: 10ms max.	
Ambient temperature	DC: -55°C to 85°C AC: -55°C to 60°C	
Shock resistance	Functional	98m/s ²
	Destructive	980m/s ²
Vibration resistance	10Hz to 55Hz 1.5mm DA	
Humidity	5% to 85% RH	
Termination	PCB & QC	
Unit weight	Approx. 36g	
Construction	Plastic sealed, Dust protected	

- Notes:** 1) For plastic sealed type, the venting-hole should be opened in test.
2) The data shown above are initial values.
3) Please find coil temperature curve in the characteristic curves below.
4) UL insulation system: Class F, Class B.

COIL

Coil power	DC type: Approx. 900mW; AC type: Approx. 2VA
------------	---

SAFETY APPROVAL RATINGS

UL/ CUL	1 Form A	AgSnO ₂ AgCdO	30A 277VAC	
			40A 277VAC	
		AgCdO	2HP 250VAC	
			1HP 125VAC	
	1 Form B	AgCdO	30A 28VDC	
			28A 277VAC	
		AgCdO	277VAC(FLA=20)(LRA=60)	
			15A 277VAC	
	1 Form C	NO	AgSnO ₂ AgCdO	10A 28VDC
				1/2HP 250VAC
			AgCdO	1/4HP 125VAC
				277VAC(FLA=10)(LRA=33)
NC		AgSnO ₂ AgCdO	30A 277VAC	
			2HP 250VAC	
		AgCdO	1HP 125VAC	
			20A 277VAC	
1 Form C	AgSnO ₂ AgCdO	20A 28VDC		
		277VAC(FLA=20)(LRA=60)		
	AgCdO	20A 277VAC		
		1/2HP 250VAC		
1 Form C	AgSnO ₂ AgCdO	1/4HP 125VAC		
		10A 277VAC		
	AgCdO	10A 28VDC		
		277VAC(FLA=10)(LRA=33)		

- Notes:** 1) All values unspecified are at room temperature.
2) Only typical loads are listed above. Other load specifications can be available upon request.



HONGFA RELAY

ISO9001, ISO/TS16949, ISO14001, OHSAS18001, IECQ QC 080000 CERTIFIED

COIL DATA

at 23°C

DC type

Nominal Voltage VDC	Pick-up Voltage VDC max.	Drop-out Voltage VDC min.	Max. Voltage VDC *	Coil Resistance Ω
5	3.75	0.5	6.5	27 x (1±10%)
6	4.50	0.6	7.8	40 x (1±10%)
9	6.75	0.9	11.7	97 x (1±10%)
12	9.00	1.2	15.6	155 x (1±10%)
15	11.25	1.5	19.5	256 x (1±10%)
18	13.50	1.8	23.4	380 x (1±10%)
24	18.00	2.4	31.2	660 x (1±10%)
48	36.00	4.8	62.4	2560 x (1±10%)
70	52.50	7.0	91	5500 x (1±10%)
110	82.50	11	143	13450 x (1±10%)

AC type

Nominal Voltage VAC	Pick-up Voltage VAC max.	Drop-out Voltage VAC min.	Max. Voltage VDC *	Coil Resistance Ω
12	9.6	2.4	15.6	25 x (1±10%)
24	19.2	4.8	31.2	100 x (1±10%)
120	96.0	24.0	156	2500 x (1±10%)
208	166.4	41	270.4	11000 x (1±10%)
220	176	44	286	13490 x (1±10%)
240	192	48	286	13490 x (1±10%)
277	220	54	360.1	15000 x (1±10%)

- Notes:** 1) When requiring pick-up voltage < 80% of nominal voltage, special order allowed.
 2) The data shown above are initial values at 50Hz. When requiring 60Hz, special order allowed.
 3) *Maximum voltage refers to the maximum voltage which relay coil could endure in a short period of time.

ORDERING INFORMATION

HF105F-2 / 018 D -1H S T F (XXX)	
Type	HF105F-2: 30A HF105F-2L: 25A
Coil voltage	DC: 5VDC to 110VDC AC: 12VAC to 277VAC
Coil voltage form	D: DC A: AC
Contact arrangement	1H:1 Form A 1D:1 Form B 1Z:1 Form C
Construction ¹⁾	S: Plastic sealed Nil: Dust protected
Contact material	T: AgSnO ₂ Nil: AgCdO
Insulation standard	F: Class F Nil: Class B
Special code³⁾	XXX: Customer special requirement Nil: Standard

- Notes:** 1) We recommend dust protected types for a clean environment (free from contaminations like H₂S, SO₂, NO₂, dust, etc.).
 We suggest to choose plastic sealed types and validate it in real application for an unclean environment (with contaminations like H₂S, SO₂, NO₂, dust, etc.).
 2) Contact is recommended for suitable condition and specifications if water cleaning or surface process is involved in assembling relays on PCB.
 3) The customer special requirement express as special code after evaluating by Hongfa.

1 Form A

Outline Dimensions

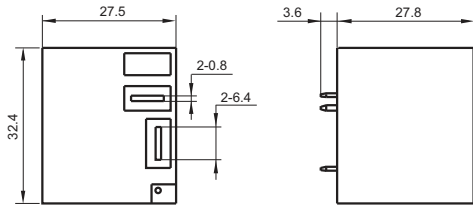

Wiring Diagram

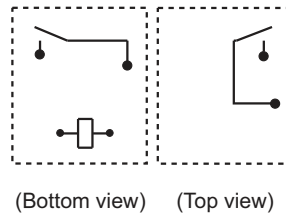

PCB Layout (Bottom view)

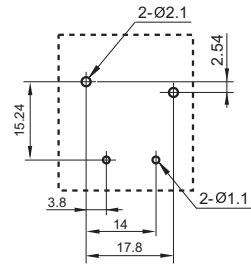

1 Form B

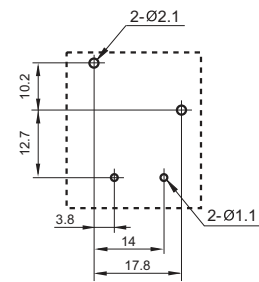
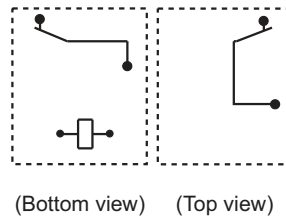
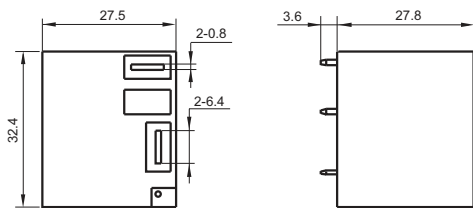

1 Form C

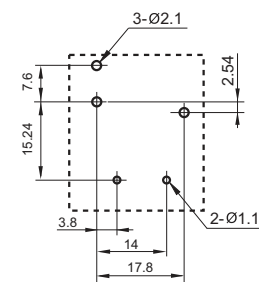
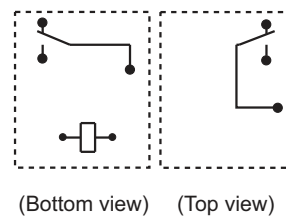
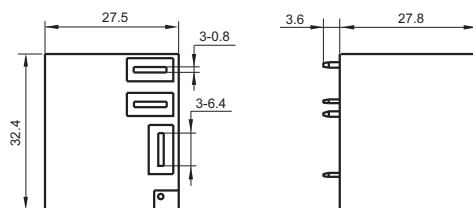

Remark: 1) In case of no tolerance shown in outline dimension: outline dimension $\leq 1\text{mm}$, tolerance should be $\pm 0.2\text{mm}$; outline dimension $> 1\text{mm}$ and $\leq 5\text{mm}$, tolerance should be $\pm 0.3\text{mm}$; outline dimension $> 5\text{mm}$, tolerance should be $\pm 0.4\text{mm}$.
 2) The tolerance without indicating for PCB layout is always $\pm 0.1\text{mm}$.

CHARACTERISTIC CURVES

MAXIMUM SWITCHING POWER

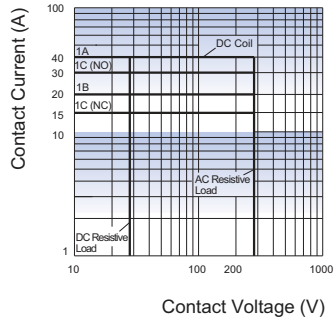

ENDURANCE CURVE

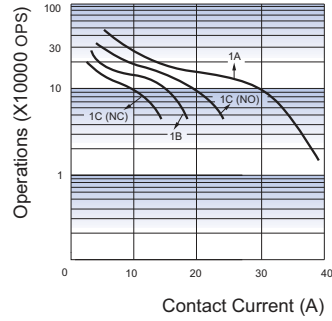

Test conditions:
Resistive load, Dust protected,
AgCdO, Room temp., 1s on 9s off.

COIL TEMPERATURE RISE

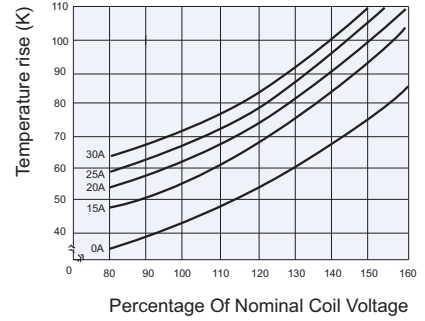

Disclaimer

The specification is for reference only. See to "Terminology and Guidelines" for more information. Specifications subject to change without notice. We could not evaluate all the performance and all the parameters for every possible application. Thus the user should be in a right position to choose the suitable product for their own application. If there is any query, please contact Hongfa for the technical service. However, it is the user's responsibility to determine which product should be used only.

HF105F-4

MINIATURE HIGH POWER RELAY



File No.:E134517



File No.:40025518 (DC type)



File No.:CQC09002031229(DC type)



Features

- 40A switching capability
- 2.5kV dielectric strength
(between coil and contacts)
- Heavy load up to 7200VA
- UL insulation system: Class F available
- Environmental friendly product (RoHS compliant)
- Outline Dimensions: (50 x 27.2 x 27.8) mm

CONTACT DATA

Contact arrangement	1A	1B	1C (NO)	1C (NC)
Contact resistance	50mΩ max.(at 1A 24VDC)			
Contact material	AgSnO ₂ , AgCdO			
Max. switching capacity	7200VA/560W	3600VA/280W	4800VA/560W	2400VA/280W
Max. switching voltage	277VAC/28VDC			
Max. switching current	40A	15A	20A	10A
HF105F-4 rating	30A 240VAC 20A 28VDC	15A 240VAC 10A 28VDC	20A 240VAC 20A 28VDC	10A 240VAC 10A 28VDC
HF105F-4L rating	25A 240VAC 20A 28VDC	15A 240VAC 10A 28VDC	20A 240VAC 20A 28VDC	10A 240VAC 10A 28VDC
Mechanical endurance	1 x 10 ⁷ OPS			
Electrical endurance	1H type(Non-plastic sealed): 1 x 10 ⁵ OPS (28A 277VAC, Resistive load, AgCdO, Room temp., 1s on 9s off)			

CHARACTERISTICS

Insulation resistance	1000MΩ (at 500VDC)	
Dielectric strength	Between coil & contacts	2500VAC 1min
	Between open contacts	1500VAC 1min
Operate time (at nomi. volt.)	DC type: 15ms max.	
Release time (at nomi. volt.)	DC type: 10ms max.	
Ambient temperature	DC: -55°C to 85°C AC: -55°C to 60°C	
Shock resistance	Functional	98m/s ²
	Destructive	980m/s ²
Vibration resistance	10Hz to 55Hz 1.5mm DA	
Humidity	5% to 85% RH	
Termination	QC	
Unit weight	Approx. 36g	
Construction	Plastic sealed, Dust protected	

Notes: 1) For plastic sealed type, the venting-hole should be opened in test.

2) The data shown above are initial values.

3) Please find coil temperature curve in the characteristic curves below.

4) UL insulation system: Class F, Class B.

COIL

Coil power	DC type: Approx. 900mW; AC type: Approx. 2VA
------------	---

SAFETY APPROVAL RATINGS

UL/ CUL	1 Form A	AgSnO ₂ AgCdO	30A 277VAC 40A 277VAC 2HP 250VAC 1HP 125VAC	
		AgCdO	30A 28VDC 28A 277VAC 277VAC(FLA=20)(LRA=60)	
	1 Form B	AgCdO	15A 277VAC 10A 28VDC 1/2HP 250VAC 1/4HP 125VAC 277VAC(FLA=10)(LRA=33)	
			30A 277VAC 2HP 250VAC 1HP 125VAC	
	1 Form C	NO	AgSnO ₂ AgCdO	20A 277VAC 20A 28VDC 277VAC(FLA=20)(LRA=60)
			AgCdO	20A 277VAC 1/2HP 250VAC 1/4HP 125VAC
1 Form C	NC	AgSnO ₂ AgCdO	10A 277VAC 10A 28VDC 277VAC(FLA=10)(LRA=33)	
		AgCdO	10A 277VAC 10A 28VDC 277VAC(FLA=10)(LRA=33)	

Notes: 1) All values unspecified are at room temperature.

2) Only typical loads are listed above. Other load specifications can be available upon request.



HONGFA RELAY

ISO9001, ISO/TS16949, ISO14001, OHSAS18001, IECQ QC 080000 CERTIFIED

COIL DATA

at 23°C

DC type

Nominal Voltage VDC	Pick-up Voltage VDC max.	Drop-out Voltage VDC min.	Max. Voltage VDC *	Coil Resistance Ω
5	3.75	0.5	6.5	27 x (1±10%)
6	4.50	0.6	7.8	40 x (1±10%)
9	6.75	0.9	11.7	97 x (1±10%)
12	9.00	1.2	15.6	155 x (1±10%)
15	11.25	1.5	19.5	256 x (1±10%)
18	13.50	1.8	23.4	380 x (1±10%)
24	18.00	2.4	31.2	660 x (1±10%)
48	36.00	4.8	62.4	2560 x (1±10%)
70	52.50	7.0	91	5500 x (1±10%)
110	82.50	11	143	13450 x (1±10%)

AC type

Nominal Voltage VAC	Pick-up Voltage VAC max.	Drop-out Voltage VAC min.	Max. Voltage VDC*	Coil Resistance Ω
12	9.6	2.4	15.6	25 x (1±10%)
24	19.2	4.8	31.2	100 x (1±10%)
120	96.0	24.0	156	2500 x (1±10%)
208	166.4	41	270.4	11000 x (1±10%)
220	176	44	286	13490 x (1±10%)
240	192	48	286	13490 x (1±10%)
277	220	54	360.1	15000 x (1±10%)

- Notes:**
- 1) When requiring pick-up voltage < 80% of nominal voltage, special order allowed.
 - 2) The data shown above are initial values at 50Hz. When requiring 60Hz, special order allowed.
 - 3) *Maximum voltage refers to the maximum voltage which relay coil could endure in a short period of time.

ORDERING INFORMATION

Type		HF105F-4: 30A HF105F-4L: 25A	
Coil voltage		DC: 5VDC to 110VDC AC: 12VAC to 277VAC	
Coil voltage form		D: DC	A: AC
Coil terminal width		K: 4.8mm	Nil: 2.8mm
Contact arrangement 1H:1 Form A 1D:1 Form B 1Z:1 Form C			
Construction ¹⁾		S: Plastic sealed	Nil: Dust protected
Contact material		T: AgSnO ₂	Nil: AgCdO
Insulation standard		F: Class F	Nil: Class B
Special code ³⁾		XXX: Customer special requirement	Nil: Standard

- Notes:**
- 1) We recommend dust protected types for a clean environment (free from contaminations like H₂S, SO₂, NO₂, dust, etc.). We suggest to choose plastic sealed types and validate it in real application for an unclean environment (with contaminations like H₂S, SO₂, NO₂, dust, etc.).
 - 2) Contact is recommended for suitable condition and specifications if water cleaning or surface process is involved in assembling relays on PCB.
 - 3) The customer special requirement express as special code after evaluating by Hongfa.

1 Form A

Outline Dimensions

**Wiring Diagram
(Top view)**

2.8mm Terminal width

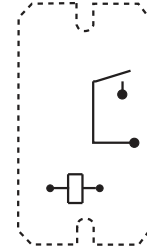
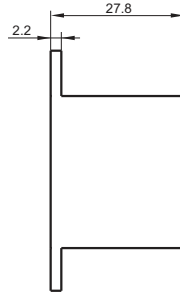
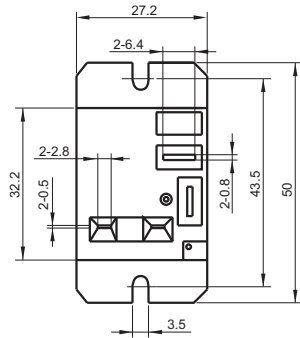

4.8mm Terminal width

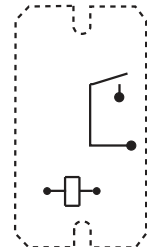
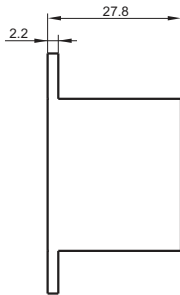
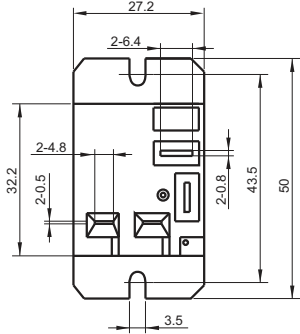

1 Form B

2.8mm Terminal width

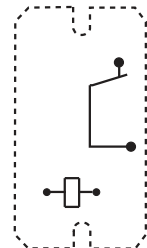
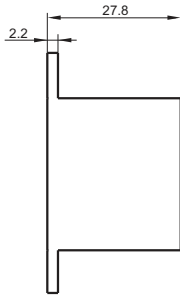
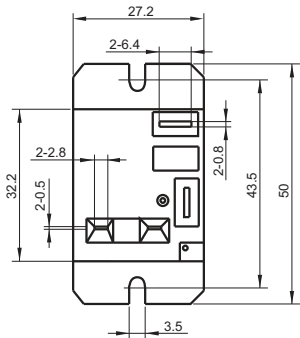

4.8mm Terminal width

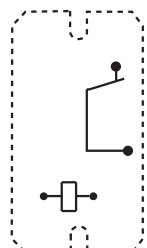
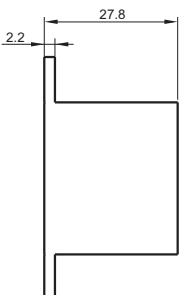
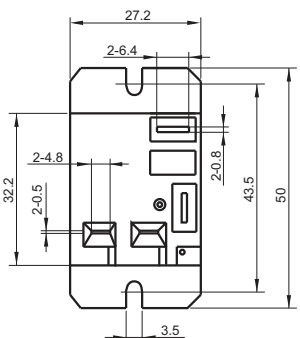

OUTLINE DIMENSIONS, WIRING DIAGRAM AND PC BOARD LAYOUT

Unit: mm

1 Form C

Outline Dimensions

Wiring Diagram (Top view)

2.8mm Terminal width

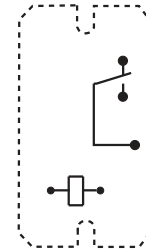
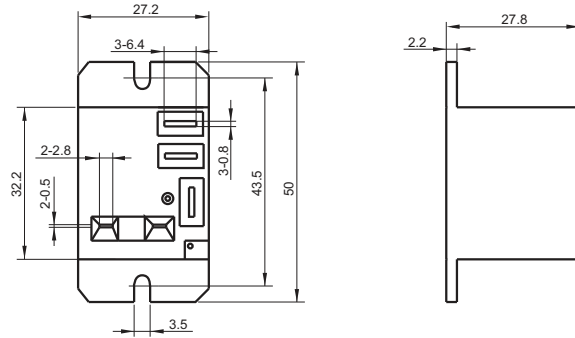

4.8mm Terminal width

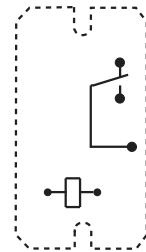
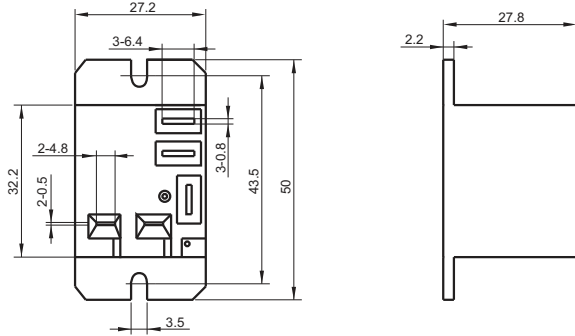

Remark: In case of no tolerance shown in outline dimension: outline dimension $\leq 1\text{mm}$, tolerance should be $\pm 0.2\text{mm}$; outline dimension $> 1\text{mm}$ and $\leq 5\text{mm}$, tolerance should be $\pm 0.3\text{mm}$; outline dimension $> 5\text{mm}$, tolerance should be $\pm 0.4\text{mm}$.

CHARACTERISTIC CURVES

MAXIMUM SWITCHING POWER

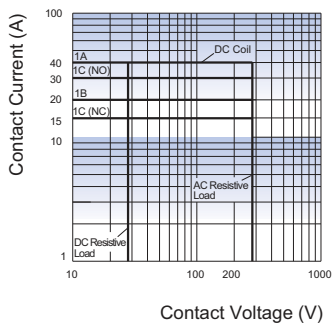

ENDURANCE CURVE

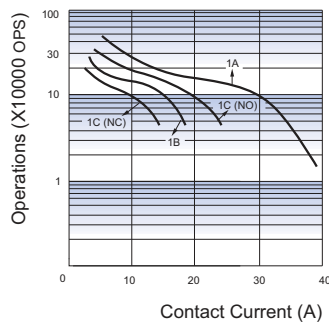

COIL TEMPERATURE RISE

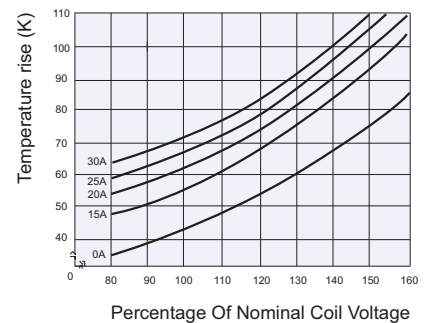

Test conditions:
Resistive load, Dust protected,
AgCdO, Room temp., 1s on 9s off.

Disclaimer

The specification is for reference only. See to "Terminology and Guidelines" for more information. Specifications subject to change without notice. We could not evaluate all the performance and all the parameters for every possible application. Thus the user should be in a right position to choose the suitable product for their own application. If there is any query, please contact Hongfa for the technical service. However, it is the user's responsibility to determine which product should be used only.

© Xiamen Hongfa Electroacoustic Co., Ltd. All rights of Hongfa are reserved.

HF105F-5

MINIATURE HIGH POWER RELAY



File No.:E134517



File No.:40025518 (DC type)



File No.:CQC09002031229(DC type)



Features

- 40A switching capability
- Heavy load up to 7200VA
- PCB coil terminals, ideal for heavy duty load
- Plastic sealed and dust protected types available
- 4kV dielectric strength (between coil and contacts)
- UL insulation system: Class F available
- Environmental friendly product (RoHS compliant)
- Outline Dimensions: (32.4 x 27.3 x 27.8) mm

CONTACT DATA

Contact arrangement	1A	1B	1C (NO)	1C (NC)
Contact resistance	50mΩ max.(at 1A 24VDC)			
Contact material	AgSnO ₂ , AgCdO			
Max. switching capacity	7200VA/560W	3600VA/280W	4800VA/560W	2400VA/280W
Max. switching voltage	277VAC / 28VDC			
Max. switching current	40A	15A	20A	10A
HF105F-5 rating	30A 240VAC 20A 28VDC	15A 240VAC 10A 28VDC	20A 240VAC 20A 28VDC	10A 240VAC 10A 28VDC
HF105F-5L rating	25A 240VAC 20A 28VDC	15A 240VAC 10A 28VDC	20A 240VAC 20A 28VDC	10A 240VAC 10A 28VDC
Mechanical endurance	1 x 10 ⁷ OPS			
Electrical endurance	1H type(Non-plastic sealed): 1 x 10 ⁵ OPS (28A 277VAC, Resistive load, AgCdO, Room temp., 1s on 9s off)			

CHARACTERISTICS

Insulation resistance	1000MΩ (at 500VDC)	
Dielectric strength	Between coil & contacts	2500VAC/4000VAC 1min
	Between open contacts	1500VAC 1min
Operate time (at nomi. volt.)	DC type: 15ms max.	
Release time (at nomi. volt.)	DC type: 10ms max.	
Ambient temperature	DC: -55°C to 85°C AC: -55°C to 60°C	
Shock resistance	Functional	98m/s ²
	Destructive	980m/s ²
Vibration resistance	10Hz to 55Hz 1.5mm DA	
Humidity	5% to 85% RH	
Termination	PCB & QC	
Unit weight	Approx. 36g	
Construction	Plastic sealed, Dust protected	

Notes: 1) For plastic sealed type, the venting-hole should be opened in test.

2) The data shown above are initial values.

3) Please find coil temperature curve in the characteristic curves below.

4) UL insulation system: Class F, Class B.

COIL

Coil power	DC type: Approx. 900mW; AC type: Approx. 2VA
------------	---

SAFETY APPROVAL RATINGS

UL/ CUL	1 Form A	AgSnO ₂ AgCdO	30A 277VAC 40A 277VAC 2HP 250VAC 1HP 125VAC
		AgCdO	30A 28VDC 28A 277VAC 277VAC(FLA=20)(LRA=60)
	1 Form B	AgCdO	15A 277VAC 10A 28VDC 1/2HP 250VAC 1/4HP 125VAC 277VAC(FLA=10)(LRA=33)
		NO	30A 277VAC 2HP 250VAC 1HP 125VAC
	1 Form C	AgCdO	20A 277VAC 20A 28VDC 277VAC(FLA=20)(LRA=60)
		NC	20A 277VAC 1/2HP 250VAC 1/4HP 125VAC
		AgCdO	10A 277VAC 10A 28VDC 277VAC(FLA=10)(LRA=33)

Notes: 1) All values unspecified are at room temperature.

2) Only typical loads are listed above. Other load specifications can be available upon request.



HONGFA RELAY

ISO9001, ISO/TS16949, ISO14001, OHSAS18001, IECQ QC 080000 CERTIFIED

COIL DATA

at 23°C

DC type

Nominal Voltage VDC	Pick-up Voltage VDC max.	Drop-out Voltage VDC min.	Max. Voltage VDC *	Coil Resistance Ω
5	3.75	0.5	6.5	27 x (1±10%)
6	4.50	0.6	7.8	40 x (1±10%)
9	6.75	0.9	11.7	97 x (1±10%)
12	9.00	1.2	15.6	155 x (1±10%)
15	11.25	1.5	19.5	256 x (1±10%)
18	13.50	1.8	23.4	380 x (1±10%)
24	18.00	2.4	31.2	660 x (1±10%)
48	36.00	4.8	62.4	2560 x (1±10%)
70	52.50	7.0	91	5500 x (1±10%)
110	82.50	11	143	13450 x (1±10%)

AC type

Nominal Voltage VAC	Pick-up Voltage VAC max.	Drop-out Voltage VAC min.	Max. Voltage VDC *	Coil Resistance Ω
12	9.6	2.4	15.6	25 x (1±10%)
24	19.2	4.8	31.2	100 x (1±10%)
120	96.0	24.0	156	2500 x (1±10%)
208	166.4	41	270.4	11000 x (1±10%)
220	176	44	286	13490 x (1±10%)
240	192	48	286	13490 x (1±10%)
277	220	54	360.1	15000 x (1±10%)

- Notes:** 1) When requiring pick-up voltage < 80% of nominal voltage, special order allowed.
 2) The data shown above are initial values at 50Hz. When requiring 60Hz, special order allowed.
 3) *Maximum voltage refers to the maximum voltage which relay coil could endure in a short period of time.

ORDERING INFORMATION

HF105F-5 / 018 D T -1H S T F (XXX)	
Type	HF105F-5: 30A HF105F-5L: 25A
Coil voltage	DC: 5VDC to 110VDC AC: 12VAC to 277VAC
Coil voltage form	D: DC A: AC
Dielectric strength (between coil & contacts)	T: 4000VAC Nil: 2500VAC
Contact arrangement	1H: 1 Form A 1D: 1 Form B 1Z: 1 Form C
Construction ¹⁾	S: Plastic sealed Nil: Dust protected
Contact material	T: AgSnO ₂ Nil: AgCdO
Insulation standard	F: Class F Nil: Class B
Special code ³⁾	XXX: Customer special requirement Nil: Standard

Notes: 1) We recommend dust protected types for a clean environment (free from contaminations like H₂S, SO₂, NO₂, dust, etc.).

We suggest to choose plastic sealed types and validate it in real application for an unclean environment (with contaminations like H₂S, SO₂, NO₂, dust, etc.).

2) Contact is recommended for suitable condition and specifications if water cleaning or surface process is involved in assembling relays on PCB.

3) The customer special requirement express as special code after evaluating by Hongfa.

1 Form A

Outline Dimensions

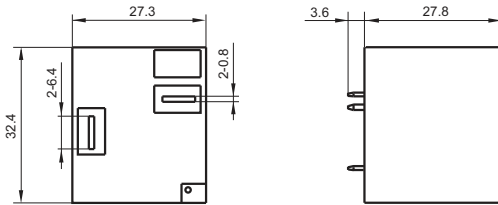

Wiring Diagram

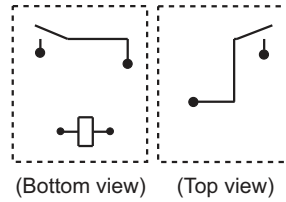

PCB Layout (Bottom view)

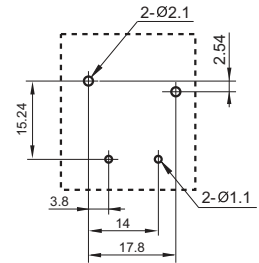

1 Form B

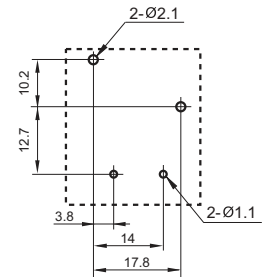
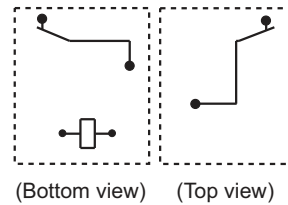
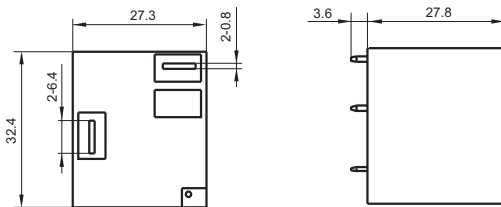

1 Form C

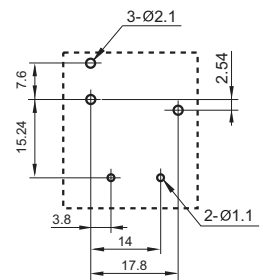
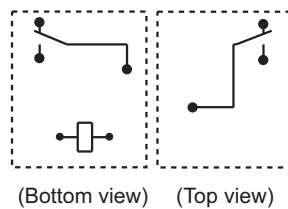
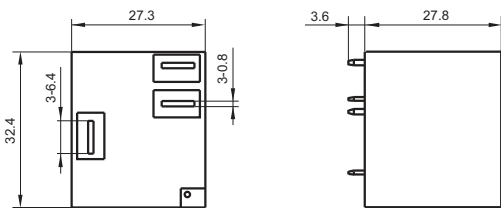

Remark: 1) In case of no tolerance shown in outline dimension: outline dimension ≤ 1 mm, tolerance should be ± 0.2 mm; outline dimension > 1 mm and ≤ 5 mm, tolerance should be ± 0.3 mm; outline dimension > 5 mm, tolerance should be ± 0.4 mm.
 2) The tolerance without indicating for PCB layout is always ± 0.1 mm.

CHARACTERISTIC CURVES

MAXIMUM SWITCHING POWER

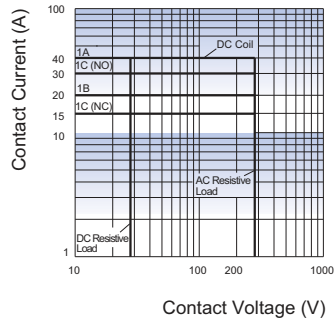

ENDURANCE CURVE

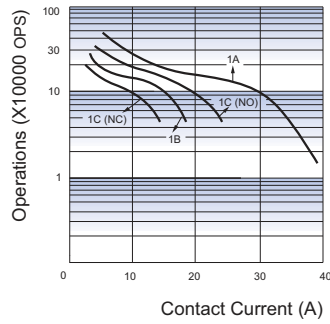

COIL TEMPERATURE RISE

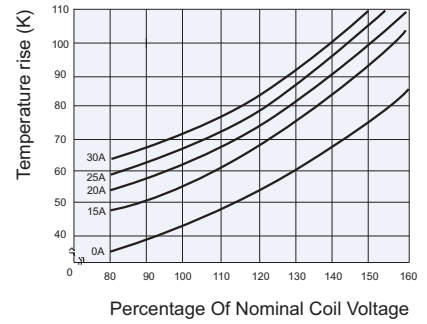

Test conditions:
Resistive load, Dust protected,
AgCdO, Room temp., 1s on 9s off.

Disclaimer

The specification is for reference only. See to "Terminology and Guidelines" for more information. Specifications subject to change without notice. We could not evaluate all the performance and all the parameters for every possible application. Thus the user should be in a right position to choose the suitable product for their own application. If there is any query, please contact Hongfa for the technical service. However, it is the user's responsibility to determine which product should be used only.

HF2100

MINIATURE HIGH POWER RELAY



File No.:E134517



File No.:R50153835



File No.:CQC10002049166



Features

- 30A switching capability
- PCB coil terminals, ideal for heavy duty load
- 2.5kV dielectric strength (between coil and contacts)
- Plastic sealed and Dust protected types available
- UL insulation system: Class F available
- Environmental friendly product (RoHS compliant)
- Outline Dimensions: (32 x 27.5 x 28.0) mm

CONTACT DATA

Contact arrangement	1A	1B	1C (NO)	1C (NC)
Contact resistance	50mΩ max.(at 1A 24VDC)			
Contact material	AgSnO ₂ , AgCdO			
Contact rating (Res. load)	30A 240VAC 20A 30VDC	15A 240VAC 10A 30VDC	20A 240VAC 20A 30VDC	10A240VAC 10A 30VDC
Max. switching power	7200VA 600W	3600VA 300W	4800VA 600W	2400VA 300W
Max. switching voltage	277VAC / 30VDC			
Max. switching current	40A	15A	20A	10A
Mechanical endurance	1 x 10 ⁷ OPS			
Electrical endurance	1A type(Non-plastic sealed): 1 x 10 ⁵ OPS (30A 240VAC, Resistive load, AgCdO, Room temp., 1s on 9s off)			

CHARACTERISTICS

Insulation resistance	1000MΩ (at 500VDC)	
Dielectric strength	Between coil & contacts	2500VAC 1min
	Between open contacts	1500VAC 1min
Operate time (at nomi. volt.)	15ms max.	
Release time (at nomi. volt.)	10ms max.	
Ambient temperature	-55°C to 85°C	
Shock resistance	Functional	98m/s ²
	Destructive	980m/s ²
Vibration resistance	10Hz to 55Hz 1.5mm DA	
Humidity	5% to 85% RH	
Termination	PCB & QC	
Unit weight	Approx. 35g	
Construction	Plastic sealed, Dust protected	

- Notes:** 1) For plastic sealed type, the venting-hole should be opened in test.
 2) The data shown above are initial values.
 3) Please find coil temperature curve in the characteristic curves below.
 4) UL insulation system: Class F, Class B.

COIL

Coil power	Approx. 900mW
------------	---------------

COIL DATA

at 23°C

Nominal Voltage VDC	Pick-up Voltage VDC max.	Drop-out Voltage VDC min.	Max. Voltage VDC*	Coil Resistance Ω
5	3.75	0.5	6.5	27 x (1±10%)
6	4.50	0.6	7.8	40 x (1±10%)
9	6.75	0.9	11.7	97 x (1±10%)
12	9.00	1.2	15.6	155 x (1±10%)
15	11.25	1.5	19.5	256 x (1±10%)
18	13.50	1.8	23.4	380 x (1±10%)
24	18.00	2.4	31.2	660 x (1±10%)
48	36.00	4.8	62.4	2560 x (1±10%)
70	52.50	7.0	91.0	5500 x (1±10%)
110	82.50	11.0	143.0	13450 x (1±10%)

Notes: *Maximum voltage refers to the maximum voltage which relay coil could endure in a short period of time.



HONGFA RELAY

ISO9001, ISO/TS16949, ISO14001, OHSAS18001, IECQ QC 080000 CERTIFIED

SAFETY APPROVAL RATINGS

UL/CUL

Contact material	Load type	Volts	1 Form A	1 Form B	1 Form C (NO)	1 Form C (NC)
AgCdO	General purpose	125/240VAC	30A	15A	30A	15A
		277VAC	30A	30A	30A	30A
	Resistive	125/240VAC	30A	15A	--	--
		30VDC	20A	10A	20A	10A
		277VAC	20A	--	--	--
		240VAC	15A	--	--	--
		250VAC	40A		40A	
	Ballast	125/240/277VAC	6A	3A	6A	3A
	Pilot duty	125VAC	800VA	290VA	800VA	290VA
		125VAC	690VA	--	690VA	--
		125VAC	800VA	--	800VA	--
		240VAC	1152VA	768VA	1152VA	768VA
		277VAC	764VA	--	764VA	--
	Motor load	125VAC	1HP	1/4HP	1HP	1/4HP
		240VAC	2HP	1HP	2HP	1HP
		125VAC	1HP	--	1HP	--
		125/277VAC	3/4HP	--	3/4HP	--
	Definite purpose (LRA-loaded rotor) (FLA-full load)	120VAC	82.8LRA, 13.8FLA	--	82.8LRA, 13.8FLA	--
		125VAC	96LRA, 30FLA	33LRA, 10FLA	60LRA, 20FLA	33LRA, 10FLA
		125VAC	60LRA, 20FLA	30LRA, 12FLA	60LRA, 20FLA	30LRA, 12FLA
		125VAC	82.8LRA, 27FLA	--	82.8LRA, 27FLA	--
		240VAC	80LRA, 30FLA	33LRA, 10FLA	60LRA, 20FLA	33LRA, 10FLA
		240VAC	41.4LRA, 6.9FLA	--	41.4LRA, 6.9FLA	--
	Tungsten	277VAC	60LRA, 20FLA	--	60LRA, 20FLA	--
		125VAC	15A	--	15A	--
		240VAC	5A	--	5A	3A
120VAC		--	3A	--	--	
AgSnO ₂	240VAC	--	3A	--	--	
	General purpose	125/240VAC	30A	--	--	--
	Resistive	250VAC	40A	--	--	--
	General purpose	240VAC	--	15A	--	--

Notes: 1) All values unspecified are at room temperature.

2) Only typical loads are listed above. Other load specifications can be available upon request.

ORDERING INFORMATION

Type	HF2100	-1A	-12D	E	T	F	(XXX)
Contact arrangement	1A: 1 Form A 1B: 1 Form B 1C: 1 Form C						
Coil voltage	5, 6, 9, 12, 15, 18, 24, 48, 70, 110VDC						
Construction ¹⁾	E: Plastic sealed		Nil: Dust protected				
Contact material	T: AgSnO ₂		Nil: AgCdO				
Insulation standard	F: Class F		Nil: Class B				
Special code ³⁾	XXX: Customer special requirement		Nil: Standard				

- Notes:** 1) We recommend dust protected types for a clean environment (free from contaminations like H₂S, SO₂, NO₂, dust, etc.). We suggest to choose plastic sealed types and validate it in real application for an unclean environment (with contaminations like H₂S, SO₂, NO₂, dust, etc.).
- 2) Contact is recommended for suitable condition and specifications if water cleaning or surface process is involved in assembling relays on PCB.
- 3) The customer special requirement express as special code after evaluating by Hongfa.

OUTLINE DIMENSIONS, WIRING DIAGRAM AND PC BOARD LAYOUT

Unit: mm

1 Form A

Outline Dimensions

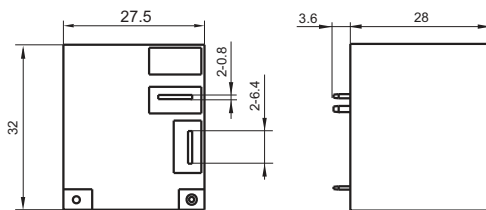

Wiring Diagram

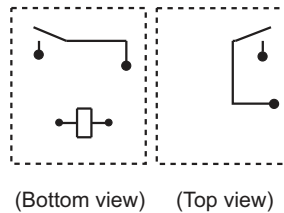

PCB Layout
(Bottom view)

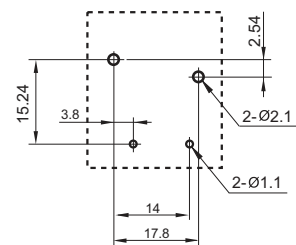

1 Form B

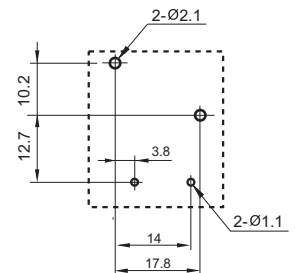
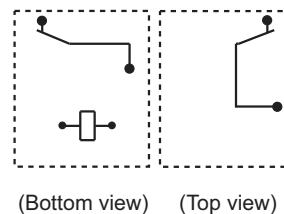
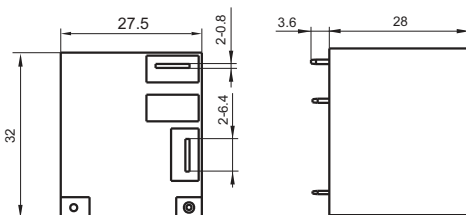

OUTLINE DIMENSIONS, WIRING DIAGRAM AND PC BOARD LAYOUT

Unit: mm

1 Form C

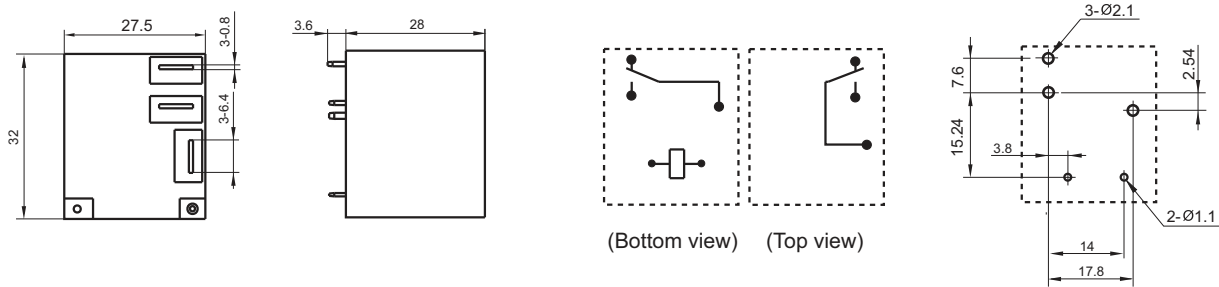

- Remark: 1) In case of no tolerance shown in outline dimension: outline dimension ≤ 1 mm, tolerance should be ± 0.2 mm; outline dimension > 1 mm and ≤ 5 mm, tolerance should be ± 0.3 mm; outline dimension > 5 mm, tolerance should be ± 0.4 mm.
 2) The tolerance without indicating for PCB layout is always ± 0.1 mm.

CHARACTERISTIC CURVES

MAXIMUM SWITCHING POWER

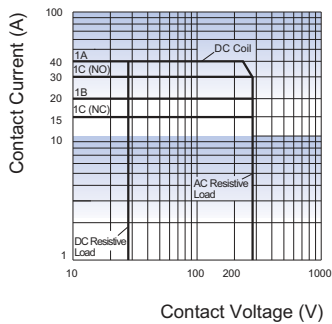

ENDURANCE CURVE

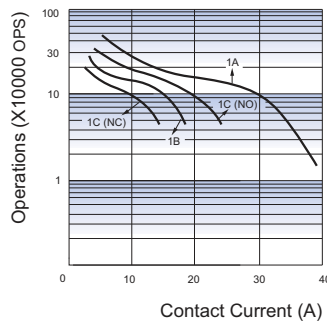

COIL TEMPERATURE RISE

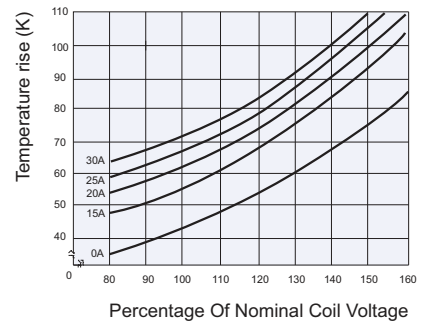

Test conditions:
 Resistive load, AgCdO, Dust protected,
 Room temp., 1s on 9s off.

Disclaimer

The specification is for reference only. See to "Terminology and Guidelines" for more information. Specifications subject to change without notice. We could not evaluate all the performance and all the parameters for every possible application. Thus the user should be in a right position to choose the suitable product for their own application. If there is any query, please contact Hongfa for the technical service. However, it is the user's responsibility to determine which product should be used only.

© Xiamen Hongfa Electroacoustic Co., Ltd. All rights of Hongfa are reserved.

HF2110/HF2120

MINIATURE HIGH POWER RELAY



File No.:E134517



File No.:CQC10002049166



Features

- 30A switching capability
- PCB coil terminals, ideal for heavy duty load
- 2.5kV dielectric strength (between coil and contacts)
- Unenclosed type available
- UL insulation system: Class F available
- Environmental friendly product (RoHS compliant)
- Outline Dimensions: (HF2110)(28.4 x 23.5 x 15.3) mm

CONTACT DATA

Contact arrangement	1A	1B	1C(NO)	1C(NC)
Contact resistance	50mΩ max.(at 1A 24VDC)			
Contact material	AgSnO ₂ , AgCdO			
Contact rating (Res. load)	30A 240VAC 20A 30VDC	15A 240VAC 10A 30VDC	20A 240VAC 20A 30VDC	10A 240VAC 10A 30VDC
Max. switching power	7200VA 600W	3600VA 300W	4800VA 600W	2400VA 300W
Max. switching voltage	277VAC / 30VDC			
Max. switching current	40A	15A	20A	10A
Mechanical endurance	1 x 10 ⁷ OPS			
Electrical endurance	1A type: 1 x 10 ⁵ OPS (30A 240VAC, Resistive load, AgCdO, Room temp., 1s on 9s off)			

COIL

Coil power	Approx. 900mW
------------	---------------

COIL DATA

at 23°C

Nominal Voltage VDC	Pick-up Voltage VDC max.	Drop-out Voltage VDC min.	Max. Voltage VDC*	Coil Resistance Ω
5	3.75	0.5	6.5	27 x (1±10%)
6	4.50	0.6	7.8	40 x (1±10%)
9	6.75	0.9	11.7	97 x (1±10%)
12	9.00	1.2	15.6	155 x (1±10%)
15	11.25	1.5	19.5	256 x (1±10%)
18	13.50	1.8	23.4	380 x (1±10%)
24	18.00	2.4	31.2	660 x (1±10%)
48	36.00	4.8	62.4	2560 x (1±10%)
70	52.50	7.0	91.0	5500 x (1±10%)
110	82.50	11.0	143.0	13450 x (1±10%)

Notes: *Maximum voltage refers to the maximum voltage which relay coil could endure in a short period of time.

CHARACTERISTICS

Insulation resistance	1000MΩ (at 500VDC)	
Dielectric strength	Between coil & contacts	HF2110/HF2120: 2500VAC 1min HF2111/HF2121: 2000VAC 1min
	Between open contacts	1500VAC 1min
Operate time (at nomi. volt.)	15ms max.	
Release time (at nomi. volt.)	10ms max.	
Ambient temperature	-55°C to 85°C	
Shock resistance	Functional	98m/s ²
	Destructive	980m/s ²
Vibration resistance	10Hz to 55Hz 1mm DA	
Humidity	5% to 85% RH	
Termination	HF2110/2111: PCB HF2120/2121: PCB & QC	
Unit weight	Approx. 25g	
Construction	Unenclosed	

- Notes:** 1) The data shown above are initial values.
2) Please find coil temperature curve in the characteristic curves below.
3) UL insulation system: Class F, Class B.



HONGFA RELAY

ISO9001, ISO/TS16949, ISO14001, OHSAS18001, IECQ QC 080000 CERTIFIED

SAFETY APPROVAL RATINGS

UL/CUL

Load type	Volts	1 Form A	1 Form B	1 Form C (NO)	1 Form C (NC)
General purpose	125/240VAC	30A	15A	30A	15A
	277VAC	30A	30A	30A	30A
Resistive	125/240VAC	30A	15A	--	--
	30VDC	20A	10A	20A	10A
	277VAC	20A	--	--	--
	240VAC	15A	--	--	--
	250VAC	40A	--	40A	--
Ballast	125/240/277VAC	6A	3A	6A	3A
Pilot duty	125VAC	800VA	290VA	800VA	290VA
	125VAC	690VA	--	690VA	--
	125VAC	800VA	--	800VA	--
	240VAC	1152VA	768VA	1152VA	768VA
	277VAC	764VA	--	764VA	--
Motor load	125VAC	1HP	1/4HP	1HP	1/4HP
	240VAC	2HP	1HP	2HP	1HP
	125VAC	1HP	--	1HP	--
	125/277VAC	3/4HP	--	3/4HP	--
Definite purpose (LRA-loaded rotor) (FLA-full load)	120VAC	82.8LRA, 13.8FLA	--	82.8LRA, 13.8FLA	--
	125VAC	96LRA, 30FLA	33LRA, 10FLA	60LRA, 20FLA	33LRA, 10FLA
	125VAC	60LRA, 20FLA	30LRA, 12FLA	60LRA, 20FLA	30LRA, 12FLA
	125VAC	82.8LRA, 27FLA	--	82.8LRA, 27FLA	--
	240VAC	80LRA, 30FLA	33LRA, 10FLA	60LRA, 20FLA	33LRA, 10FLA
	240VAC	41.4LRA, 6.9FLA	--	41.4LRA, 6.9FLA	--
Tungsten	277VAC	60LRA, 20FLA	--	60LRA, 20FLA	--
	125VAC	15A	--	15A	--
	240VAC	5A	--	5A	3A
	120VAC	--	3A	--	--
	240VAC	--	3A	--	--

Notes: 1) All values unspecified are at room temperature.

2) Only typical loads are listed above. Other load specifications can be available upon request.

ORDERING INFORMATION

	HF2110 HF2120	-1A	-12D	T	F	(XXX)
Type						
Contact arrangement	1A: 1 Form A 1B: 1 Form B 1C: 1 Form C					
Coil voltage	5, 6, 9, 12, 15, 18, 24, 48, 70, 110VDC					
Contact material	T: AgSnO ₂		Nil: AgCdO			
Insulation standard	F: Class F		Nil: Class B			
Special code ⁵⁾	XXX: Customer special requirement		Nil: Standard			

Notes: 1) To avoid using relays under strong magnetic field which will change the parameters of relays such as pick-up voltage and drop-out voltage.

2) Relays may be damaged because of falling or when shocking conditions exceed the requirement.

3) About preferable condition of operation, storage and transportation, please refer to "Explanation to terminology and guidelines of relay".

4) For unenclosed type, because there is no cover protection, the products may be contaminated by particles during transportation assembly or usage, which may cause relay failure, so the products should be effectively protected at customer side, Hongfa suggest to use HF2150/HF2160 type, if no other special requirement.

5) The customer special requirement express as special code after evaluating by Hongfa.

OUTLINE DIMENSIONS, WIRING DIAGRAM AND PC BOARD LAYOUT

Unit: mm

1 Form A

HF2111 Outline Dimensions

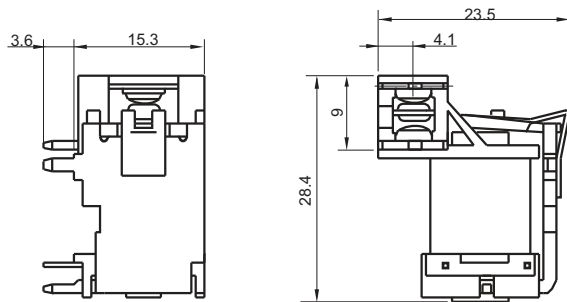

Wiring Diagram (Bottom view)

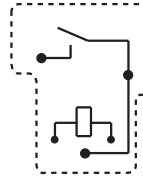

PCB Layout (Bottom view)

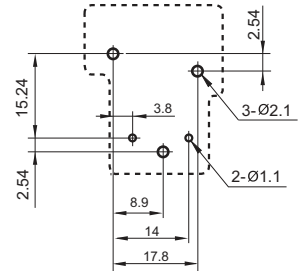

HF2110

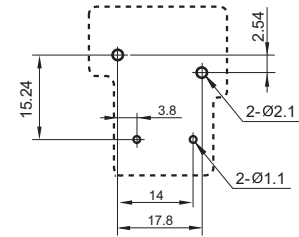
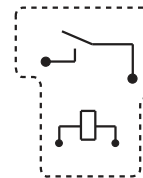
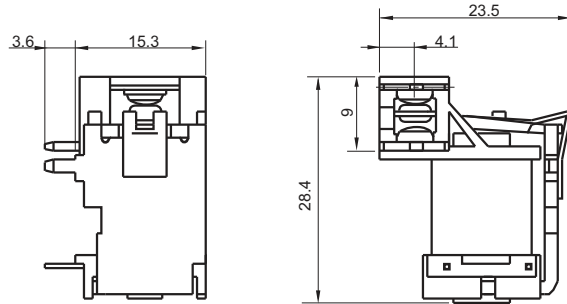

1 Form B

HF2111

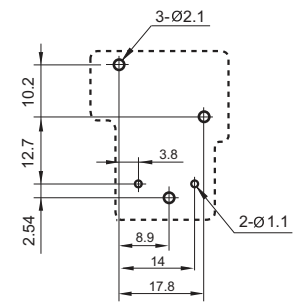
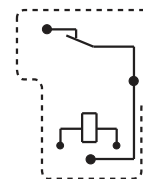
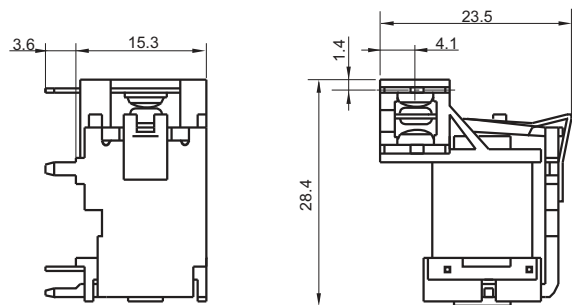

HF2110

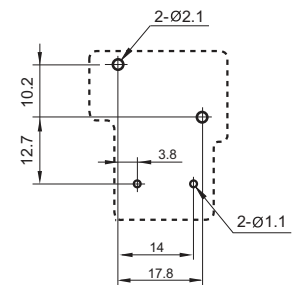
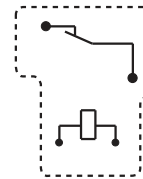
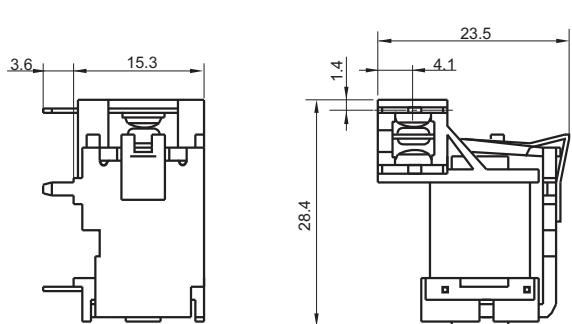

1 Form C

Outline Dimensions

HF2111

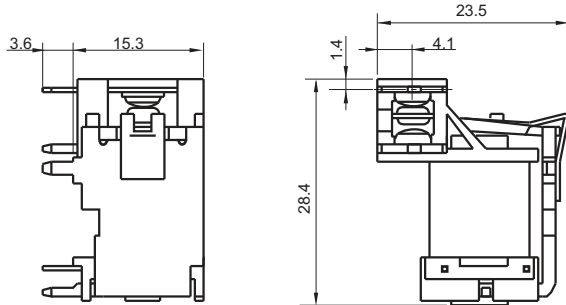

Wiring Diagram
(Bottom view)

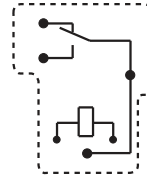

PCB Layout
(Bottom view)

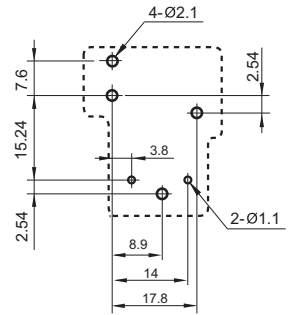

HF2110

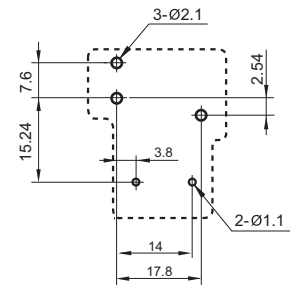
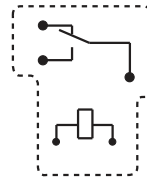
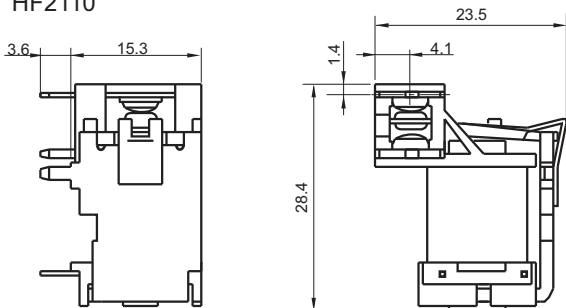

1 Form A

HF2121

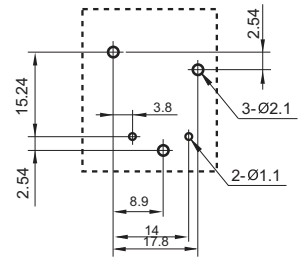
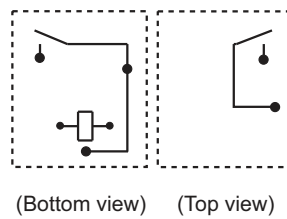
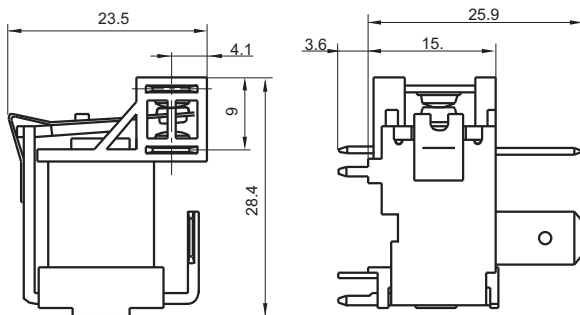

HF2120

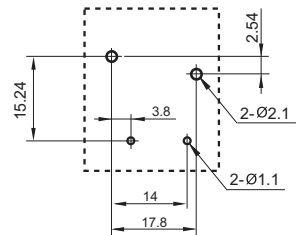
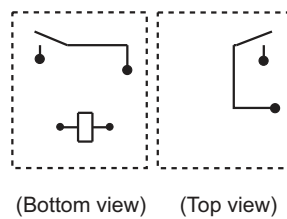
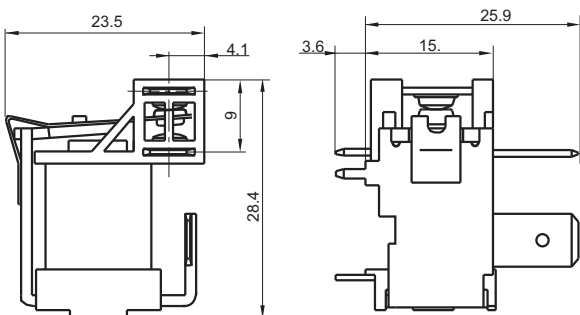

OUTLINE DIMENSIONS, WIRING DIAGRAM AND PC BOARD LAYOUT

Unit: mm

1 Form B

Outline Dimensions

HF2121

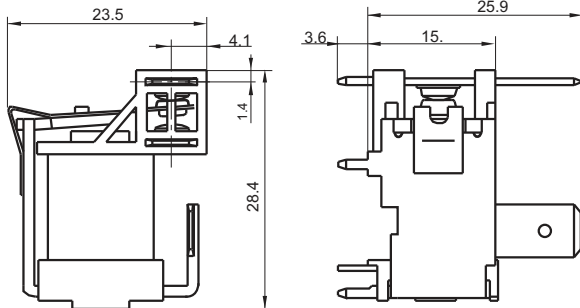

Wiring Diagram

(Bottom view)

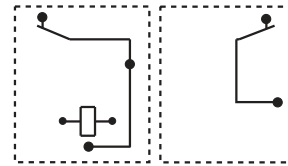

(Bottom view) (Top view)

PCB Layout

(Bottom view)

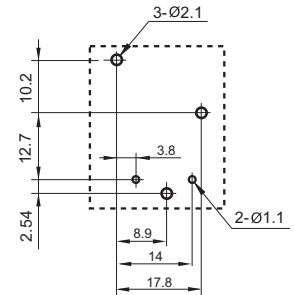

HF2120

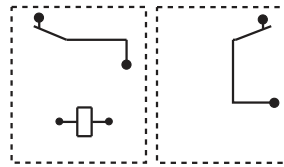
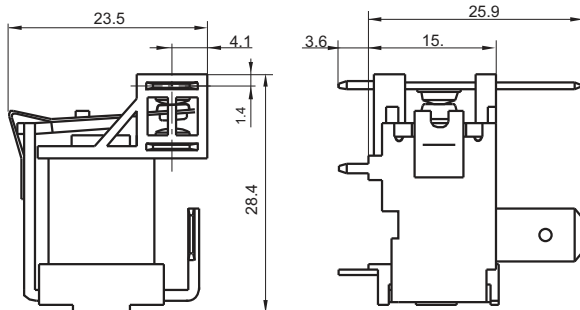

(Bottom view) (Top view)

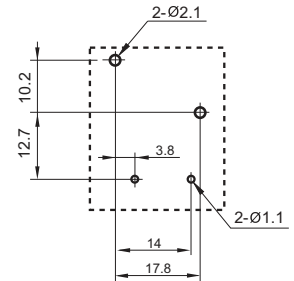

1 Form C

HF2121

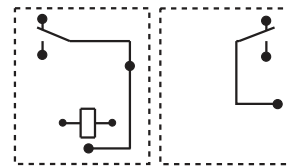
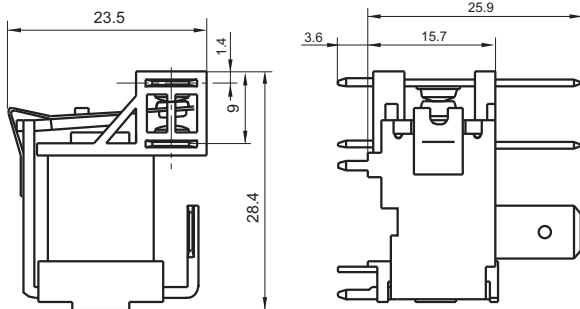

(Bottom view) (Top view)

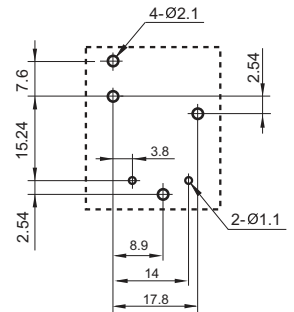

HF2120

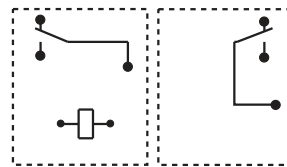
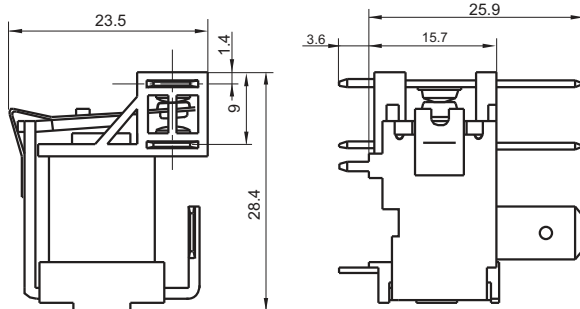

(Bottom view) (Top view)

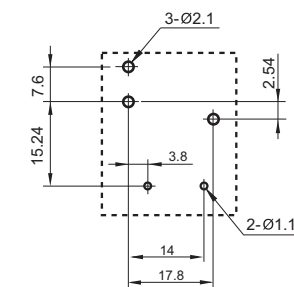

Remark: 1) In case of no tolerance shown in outline dimension: outline dimension $\leq 1\text{mm}$, tolerance should be $\pm 0.2\text{mm}$; outline dimension $> 1\text{mm}$ and $\leq 5\text{mm}$, tolerance should be $\pm 0.3\text{mm}$; outline dimension $> 5\text{mm}$, tolerance should be $\pm 0.4\text{mm}$.
2) The tolerance without indicating for PCB layout is always $\pm 0.1\text{mm}$.

CHARACTERISTIC CURVES

MAXIMUM SWITCHING POWER

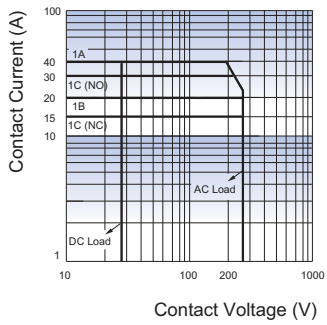

ENDURANCE CURVE

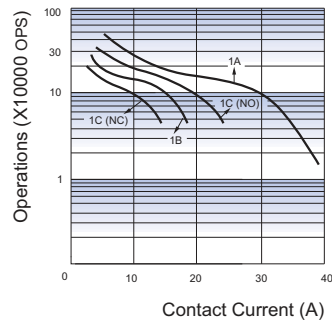

COIL TEMPERATURE RISE

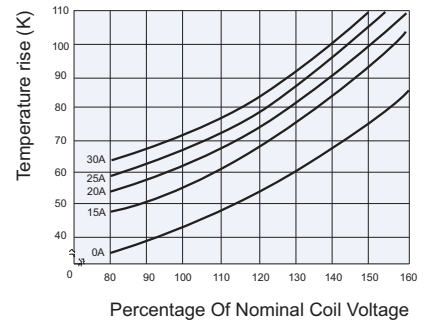

Test conditions:

Resistive load, AgCdO, Room temp.,
1s on 9s off.

Disclaimer

The specification is for reference only. See to "Terminology and Guidelines" for more information. Specifications subject to change without notice. We could not evaluate all the performance and all the parameters for every possible application. Thus the user should be in a right position to choose the suitable product for their own application. If there is any query, please contact Hongfa for the technical service. However, it is the user's responsibility to determine which product should be used only.

HF2150/HF2151

MINIATURE HIGH POWER RELAY



File No.:E134517



File No.: R50153835



File No.:CQC10002049166



Features

- 30A switching capability
- PCB coil terminals, ideal for heavyduty load
- Heavy load up to 7200VA
- Plastic sealed and Dust protected type available
- UL insulation system: Class F available
- Environmental friendly product (RoHS compliant)
- Outline Dimensions: (31.8 x 27.0 x 19.1) mm

CONTACT DATA

Contact arrangement	1A	1B	1C(NO)	1C(NC)
Contact resistance	50mΩ max.(at 1A 24VDC)			
Contact material	AgSnO ₂ , AgCdO			
Contact rating (Res. load)	30A 240VAC 20A 30VDC	15A 240VAC 10A 30VDC	20A 240VAC 20A 30VDC	10A 240VAC 10A 30VDC
Max. switching power	7200VA 600W	3600VA 300W	4800VA 600W	2400VA 300W
Max. switching voltage	277VAC / 30VDC			
Max. switching current	40A	15A	20A	10A
Mechanical endurance	1 x 10 ⁷ OPS			
Electrical endurance	1A type(Non-plastic sealed): 1 x 10 ⁵ OPS (30A 240VAC, Resistive load, AgCdO, Room temp., 1s on 9s off)			

CHARACTERISTICS

Insulation resistance	1000MΩ (at 500VDC)	
Dielectric strength	Between coil & contacts	HF2150: 2500VAC 1min HF2151: 2000VAC 1min
	Between open contacts	1500VAC 1min
Operate time (at nomi. volt.)	15ms max.	
Release time (at nomi. volt.)	10ms max.	
Ambient temperature	-55°C to 85°C	
Shock resistance	Functional	98m/s ²
	Destructive	980m/s ²
Vibration resistance	10Hz to 55Hz 1.5mm DA	
Humidity	5% to 85% RH	
Termination	PCB	
Unit weight	Approx. 30g	
Construction	Plastic sealed, Dust protected	

Notes: 1) For plastic sealed type, the venting-hole should be opened in test.

2) The data shown above are initial values.

3) Please find coil temperature curve in the characteristic curves below.

4) UL insulation system: Class F, Class B.

COIL

Coil power Approx. 900mW

COIL DATA

at 23°C

Nominal Voltage VDC	Pick-up Voltage VDC max.	Drop-out Voltage VDC min.	Max. Voltage VDC*	Coil Resistance Ω
5	3.75	0.5	6.5	27 x (1±10%)
6	4.50	0.6	7.8	40 x (1±10%)
9	6.75	0.9	11.7	97 x (1±10%)
12	9.00	1.2	15.6	155 x (1±10%)
15	11.25	1.5	19.5	256 x (1±10%)
18	13.50	1.8	23.4	380 x (1±10%)
24	18.00	2.4	31.2	660 x (1±10%)
48	36.00	4.8	62.4	2560 x (1±10%)
70	52.50	7.0	91.0	5500 x (1±10%)
110	82.50	11.0	143.0	13450 x (1±10%)

Notes: *Maximum voltage refers to the maximum voltage which relay coil could endure in a short period of time.



HONGFA RELAY

ISO9001, ISO/TS16949, ISO14001, OHSAS18001, IECQ QC 080000 CERTIFIED

SAFETY APPROVAL RATINGS

UL/CUL

Contact material	Load type	Volts	1 Form A	1 Form B	1 Form C (NO)	1 Form C (NC)	
AgCdO	General purpose	125/240VAC	30A	15A	30A	15A	
		277VAC	30A	30A	30A	30A	
	Resistive	125/240VAC	30A	15A	--	--	
		30VDC	20A	10A	20A	10A	
		277VAC	20A	--	--	--	
		240VAC	15A	--	--	--	
		250VAC	40A			40A	
	Ballast	125/240/277VAC	6A	3A	6A	3A	
	Pilot duty	125VAC	800VA	290VA	800VA	290VA	
		125VAC	690VA	--	690VA	--	
		125VAC	800VA	--	800VA	--	
		240VAC	1152VA	768VA	1152VA	768VA	
		277VAC	764VA	--	764VA	--	
	Motor load	125VAC	1HP	1/4HP	1HP	1/4HP	
		240VAC	2HP	1HP	2HP	1HP	
		125VAC	1HP	--	1HP	--	
		125/277VAC	3/4HP	--	3/4HP	--	
	Definite purpose (LRA-loaded rotor) (FLA-full load)	120VAC	82.8LRA, 13.8FLA	--	82.8LRA, 13.8FLA	--	
		125VAC	96LRA, 30FLA	33LRA, 10FLA	60LRA, 20FLA	33LRA, 10FLA	
		125VAC	60LRA, 20FLA	30LRA, 12FLA	60LRA, 20FLA	30LRA, 12FLA	
		125VAC	82.8LRA, 27FLA	--	82.8LRA, 27FLA	--	
		240VAC	80LRA, 30FLA	33LRA, 10FLA	60LRA, 20FLA	33LRA, 10FLA	
		240VAC	41.4LRA, 6.9FLA	--	41.4LRA, 6.9FLA	--	
	Tungsten	277VAC	60LRA, 20FLA	--	60LRA, 20FLA	--	
		125VAC	15A	--	15A	--	
		240VAC	5A	--	5A	3A	
		120VAC	--	3A	--	--	
	AgSnO ₂	240VAC	--	3A	--	--	
		General purpose	125/240VAC	30A	--	--	--
		Resistive	250VAC	40A	--	--	--
General purpose	240VAC	--	15A	--	--		

Notes: 1) All values unspecified are at room temperature.

2) Only typical loads are listed above. Other load specifications can be available upon request.

ORDERING INFORMATION

Type	HF2150	-1A	-12D	E	T	F	(XXX)
	HF2151						
Contact arrangement	1A: 1 Form A 1B: 1 Form B 1C: 1 Form C						
Coil voltage	5, 6, 9, 12, 15, 18, 24, 48, 70, 110VDC						
Construction ¹⁾	E: Plastic sealed		Nil: Dust protected				
Contact material	T: AgSnO ₂		Nil: AgCdO				
Insulation standard	F: Class F		Nil: Class B				
Special code ³⁾	XXX: Customer special requirement			Nil: Standard			

Notes: 1) We recommend dust protected types for a clean environment (free from contaminations like H₂S, SO₂, NO₂, dust, etc.). We suggest to choose plastic sealed types and validate it in real application for an unclean environment (with contaminations like H₂S, SO₂, NO₂, dust, etc.).

2) Contact is recommended for suitable condition and specifications if water cleaning or surface process is involved in assembling relays on PCB.

3) The customer special requirement express as special code after evaluating by Hongfa.

1 Form A

Outline Dimensions

Wiring Diagram
(Bottom view)

PCB Layout
(Bottom view)

HF2151

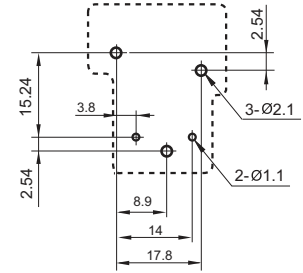
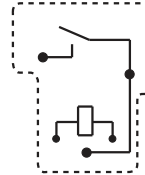
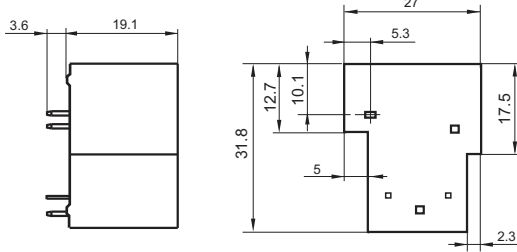

HF2150

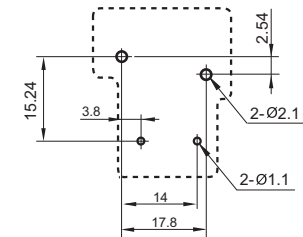
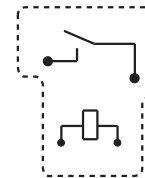
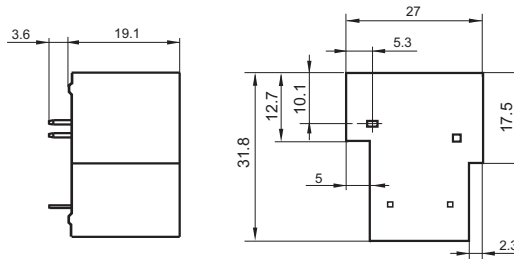

1 Form B

HF2151

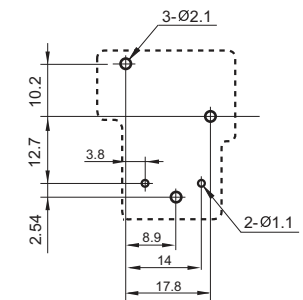
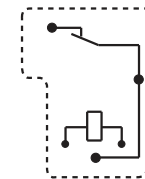
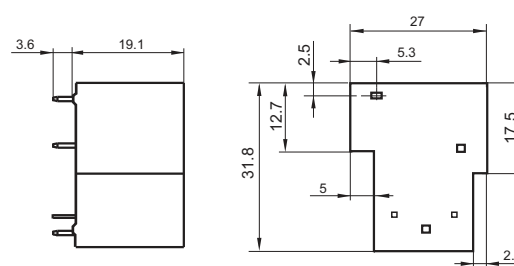

HF2150

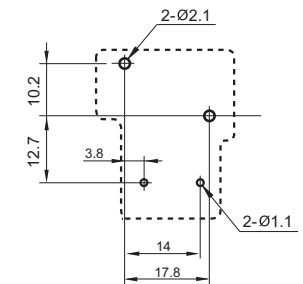
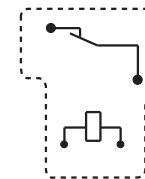
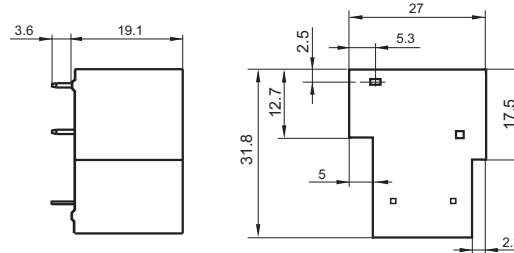

OUTLINE DIMENSIONS, WIRING DIAGRAM AND PC BOARD LAYOUT

Unit: mm

1 Form C

Outline Dimensions

Wiring Diagram (Bottom view)

PCB Layout (Bottom view)

HF2151

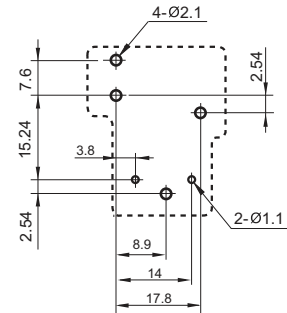
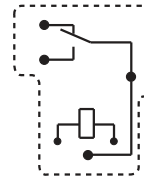
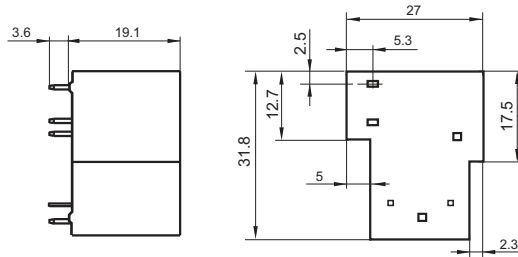

HF2150

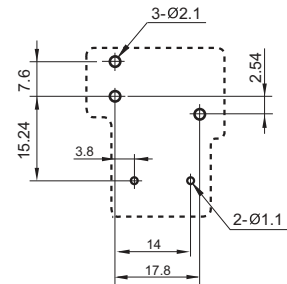
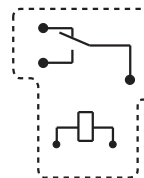
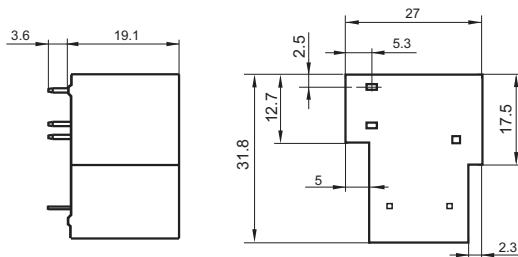

Remark: 1) In case of no tolerance shown in outline dimension: outline dimension $\leq 1\text{mm}$, tolerance should be $\pm 0.2\text{mm}$; outline dimension $> 1\text{mm}$ and $\leq 5\text{mm}$, tolerance should be $\pm 0.3\text{mm}$; outline dimension $> 5\text{mm}$, tolerance should be $\pm 0.4\text{mm}$.
2) The tolerance without indicating for PCB layout is always $\pm 0.1\text{mm}$.

CHARACTERISTIC CURVES

MAXIMUM SWITCHING POWER

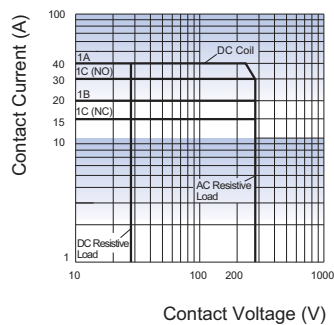

ENDURANCE CURVE

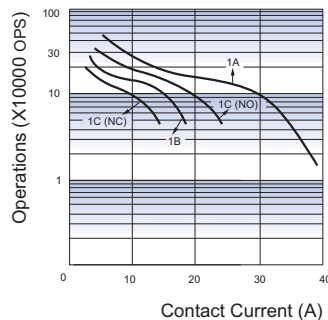

COIL TEMPERATURE RISE

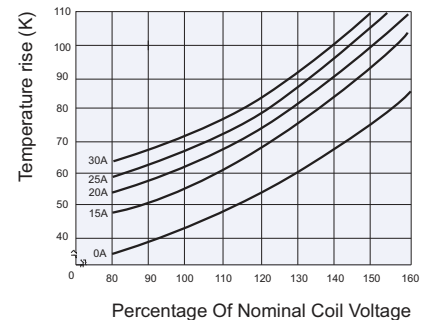

Test conditions:

Resistive load, AgCdO, Dust protected,
Room temp., 1s on 9s off.

Disclaimer

The specification is for reference only. See to "Terminology and Guidelines" for more information. Specifications subject to change without notice. We could not evaluate all the performance and all the parameters for every possible application. Thus the user should be in a right position to choose the suitable product for their own application. If there is any query, please contact Hongfa for the technical service. However, it is the user's responsibility to determine which product should be used only.

HF2160

MINIATURE HIGH POWER RELAY



File No.:E134517



File No.: R50153835



File No.:CQC10002049166



Features

- 30A switching capability
- PCB coil terminals, ideal for heavy duty load
- 2.5kV dielectric strength (between coil and contacts)
- Plastic sealed and Dust protected types available
- UL insulation system: Class F available
- Environmental friendly product (RoHS compliant)
- Outline Dimensions: (32 x 27.5 x 19.8) mm

CONTACT DATA

Contact arrangement	1A	1B	1C (NO)	1C (NC)
Contact resistance	50mΩ max.(at 1A 24VDC)			
Contact material	AgSnO ₂ , AgCdO			
Contact rating (Res. load)	30A 240VAC 20A 30VDC	15A 240VAC 10A 30VDC	20A 240VAC 20A 30VDC	10A 240VAC 10A 30VDC
Max. switching power	7200VA 600W	3600VA 300W	4800VA 600W	2400VA 300W
Max. switching voltage	277VAC / 30VDC			
Max. switching current	40A	15A	20A	10A
Mechanical endurance	1 x 10 ⁷ OPS			
Electrical endurance	1A type(Non-plastic sealed): 1 x 10 ⁵ OPS (30A 240VAC, Resistive load, AgCdO, Room temp., 1s on 9s off)			

CHARACTERISTICS

Insulation resistance	1000MΩ (at 500VDC)	
Dielectric strength	Between coil & contacts	2500VAC 1min
	Between open contacts	1500VAC 1min
Operate time (at nomi. volt.)	15ms max.	
Release time (at nomi. volt.)	10ms max.	
Ambient temperature	-55°C to 85°C	
Shock resistance	Functional	98m/s ²
	Destructive	980m/s ²
Vibration resistance	10Hz to 55Hz 1.5mm DA	
Humidity	5% to 85% RH	
Termination	PCB & QC	
Unit weight	Approx. 30g	
Construction	Plastic sealed, Dust protected	

- Notes:** 1) For plastic sealed type, the venting-hole should be opened in test.
 2) The data shown above are initial values.
 3) Please find coil temperature curve in the characteristic curves below.
 4) UL insulation system: Class F, Class B.

COIL

Coil power	Approx. 900mW
------------	---------------

COIL DATA

at 23°C

Nominal Voltage VDC	Pick-up Voltage VDC max.	Drop-out Voltage VDC min.	Max. Voltage VDC*	Coil Resistance Ω
5	3.75	0.5	6.5	27 x (1±10%)
6	4.50	0.6	7.8	40 x (1±10%)
9	6.75	0.9	11.7	97 x (1±10%)
12	9.00	1.2	15.6	155 x (1±10%)
15	11.25	1.5	19.5	256 x (1±10%)
18	13.50	1.8	23.4	380 x (1±10%)
24	18.00	2.4	31.2	660 x (1±10%)
48	36.00	4.8	62.4	2560 x (1±10%)
70	52.50	7.0	91.0	5500 x (1±10%)
110	82.50	11.0	143.0	13450 x (1±10%)

Notes: *Maximum voltage refers to the maximum voltage which relay coil could endure in a short period of time.



HONGFA RELAY

ISO9001, ISO/TS16949, ISO14001, OHSAS18001, IECQ QC 080000 CERTIFIED

SAFETY APPROVAL RATINGS

UL/CUL

Contact material	Load type	Volts	1 Form A	1 Form B	1 Form C (NO)	1 Form C (NC)	
AgCdO	General purpose	125/240VAC	30A	15A	30A	15A	
		277VAC	30A	30A	30A	30A	
	Resistive	125/240VAC	30A	15A	--	--	
		30VDC	20A	10A	20A	10A	
		277VAC	20A	--	--	--	
		240VAC	15A	--	--	--	
		250VAC	40A		40A		
	Ballast	125/240/277VAC	6A	3A	6A	3A	
	Pilot duty	125VAC	800VA	290VA	800VA	290VA	
		125VAC	690VA	--	690VA	--	
		125VAC	800VA	--	800VA	--	
		240VAC	1152VA	768VA	1152VA	768VA	
		277VAC	764VA	--	764VA	--	
	Motor load	125VAC	1HP	1/4HP	1HP	1/4HP	
		240VAC	2HP	1HP	2HP	1HP	
		125VAC	1HP	--	1HP	--	
		125/277VAC	3/4HP	--	3/4HP	--	
	Definite purpose (LRA-loaded rotor) (FLA-full load)	120VAC	82.8LRA, 13.8FLA	--	82.8LRA, 13.8FLA	--	
		125VAC	96LRA, 30FLA	33LRA, 10FLA	60LRA, 20FLA	33LRA, 10FLA	
		125VAC	60LRA, 20FLA	30LRA, 12FLA	60LRA, 20FLA	30LRA, 12FLA	
		125VAC	82.8LRA, 27FLA	--	82.8LRA, 27FLA	--	
		240VAC	80LRA, 30FLA	33LRA, 10FLA	60LRA, 20FLA	33LRA, 10FLA	
		240VAC	41.4LRA, 6.9FLA	--	41.4LRA, 6.9FLA	--	
		277VAC	60LRA, 20FLA	--	60LRA, 20FLA	--	
	Tungsten	125VAC	15A	--	15A	--	
		240VAC	5A	--	5A	3A	
		120VAC	--	3A	--	--	
		240VAC	--	3A	--	--	
	AgSnO ₂	General purpose	125/240VAC	30A	--	--	--
		Resistive	250VAC	40A	--	--	--
General purpose		240VAC	--	15A	--	--	

Notes: 1) All values unspecified are at room temperature.

2) Only typical loads are listed above. Other load specifications can be available upon request.

ORDERING INFORMATION

Type	HF2160	-1A	-12D	E	T	F	(XXX)
Contact arrangement	1A: 1 Form A 1B: 1 Form B 1C: 1 Form C						
Coil voltage	5, 6, 9, 12, 15, 18, 24, 48, 70, 110VDC						
Construction ¹⁾²⁾	E: Plastic sealed Nil: Dust protected						
Contact material	T: AgSnO ₂		Nil: AgCdO				
Insulation standard	F: Class F		Nil: Class B				
Special code ³⁾	XXX: Customer special requirement			Nil: Standard			

- Notes:** 1) We recommend dust protected types for a clean environment (free from contaminations like H₂S, SO₂, NO₂, dust, etc.). We suggest to choose plastic sealed types and validate it in real application for an unclean environment (with contaminations like H₂S, SO₂, NO₂, dust, etc.).
 2) Contact is recommended for suitable condition and specifications if water cleaning or surface process is involved in assembling relays on PCB.
 3) The customer special requirement express as special code after evaluating by Hongfa.

OUTLINE DIMENSIONS, WIRING DIAGRAM AND PC BOARD LAYOUT

Unit: mm

1 Form A

Outline Dimensions

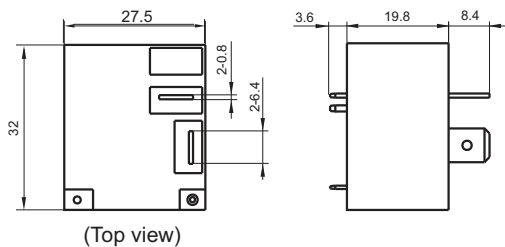

Wiring Diagram

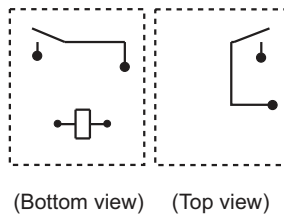

PCB Layout
(Bottom view)

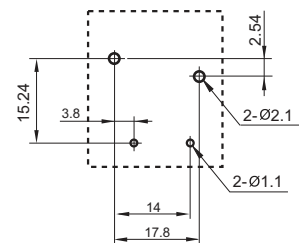

1 Form B

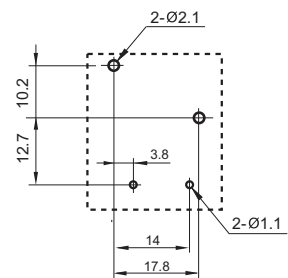
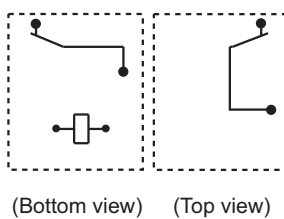
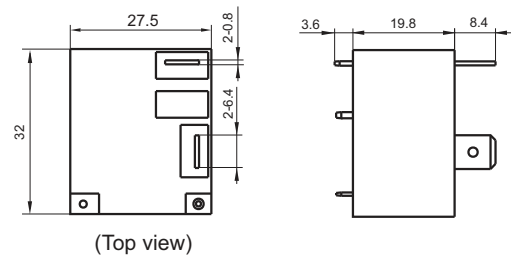

OUTLINE DIMENSIONS, WIRING DIAGRAM AND PC BOARD LAYOUT

Unit: mm

1 Form C

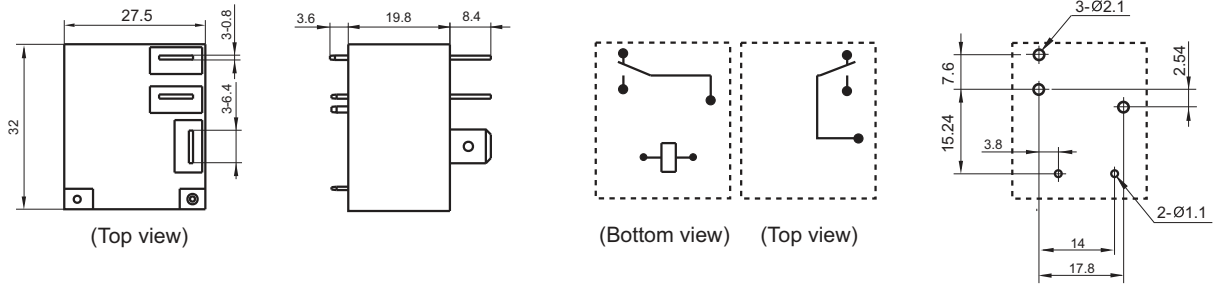

Remark: 1) In case of no tolerance shown in outline dimension: outline dimension $\leq 1\text{mm}$, tolerance should be $\pm 0.2\text{mm}$; outline dimension $> 1\text{mm}$ and $\leq 5\text{mm}$, tolerance should be $\pm 0.3\text{mm}$; outline dimension $> 5\text{mm}$, tolerance should be $\pm 0.4\text{mm}$.
 2) The tolerance without indicating for PCB layout is always $\pm 0.1\text{mm}$.

CHARACTERISTIC CURVES

MAXIMUM SWITCHING POWER

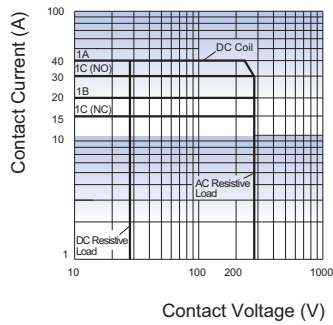

ENDURANCE CURVE

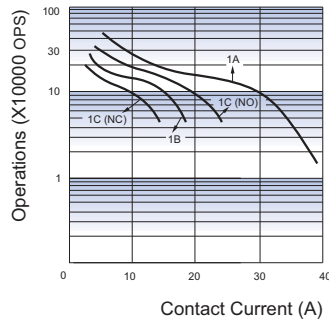

COIL TEMPERATURE RISE

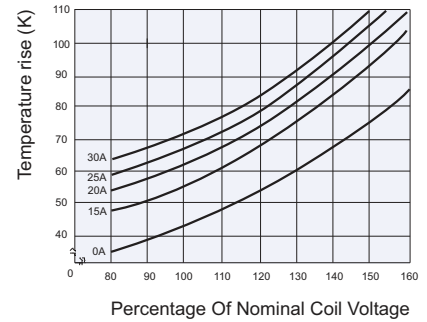

Test conditions:
 Resistive load, AgCdO, Dust protected,
 Room temp., 1s on 9s off.

Disclaimer

The specification is for reference only. See to "Terminology and Guidelines" for more information. Specifications subject to change without notice. We could not evaluate all the performance and all the parameters for every possible application. Thus the user should be in a right position to choose the suitable product for their own application. If there is any query, please contact Hongfa for the technical service. However, it is the user's responsibility to determine which product should be used only.

HF116F-1

MINIATURE HIGH POWER RELAY



File No.:E134517



File No.:R50154722



File No.:CQC09002031231(DC type)



Features

- 30A switching capability
- 4kV dielectric strength (between coil and contacts)
- 3mm contact gap available
- UL insulation system: Class F available
- Environmental friendly product (RoHS compliant)
- Outline Dimensions: (50.5 x 32.9 x 36.0) mm

CONTACT DATA

Contact arrangement	1A	2A
Contact resistance	100mΩ max.(at 1A 24VDC)	
Contact material	AgSnO ₂ , AgCdO	
Contact rating (Res. load)	30A 240VAC 30A 277VAC	25A 240VAC 25A 277VAC
Max. switching voltage	277VAC	
Max. switching current	30A	25A
Max. switching power	8310VA	6925VA
Mechanical endurance	1 x 10 ⁷ OPS	
Electrical endurance	1H,1HT type: 1 x 10 ⁵ OPS (30A 240VAC, Resistive load, Room temp., 1s on 9s off) 2H,2HT type: 1 x 10 ⁵ OPS (25A 240VAC, Resistive load, Room temp., 1s on 9s off)	

CHARACTERISTICS

Insulation resistance	1000MΩ (at 500VDC)	
Dielectric strength	Between coil & contacts	4000VAC 1min
	Between open contacts	2000VAC 1min
Operate time (at nomi. volt.)	30ms max.(DC type)	
Release time (at nomi. volt.)	30ms max.(DC type)	
Shock resistance	Functional	Standard:98m/s ² Pulse width 11ms W type:98m/s ² Pulse width 6ms
	Destructive	980m/s ² Pulse width 6ms
Vibration resistance	Standard:10H to 55Hz 1.5mm DA W type:10H to 55Hz 1.0mm DA	
Ambient temperature	-55°C to 70°C	
Humidity	5% to 85% RH	
Termination	PCB, QC, Screw	
Unit weight	Approx. 120g	
Construction	Dust protected	

- Notes: 1) The data shown above are initial values.
2) Please find coil temperature curve in the characteristic curves below.
3) UL insulation system: Class F, Class B.

COIL

Coil power	DC type: Approx. 1.9W; AC type: Approx. 2.7VA
------------	--

COIL DATA

at 23°C

Nominal Voltage VDC	Pick-up Voltage VDC max.	Drop-out Voltage VDC min.	Max. Voltage VDC*	Coil Resistance Ω
3	2.25	0.3	3.3	4.7 x (1±10%)
6	4.50	0.6	6.6	18.8 x (1±10%)
12	9.00	1.2	13.2	75 x (1±10%)
24	18.0	2.4	26.4	300 x (1±10%)
48	36.0	4.8	52.8	1200 x (1±10%)
100	75.0	10.0	110	5200 x (1±10%)
110	82.5	11.0	121	6300 x (1±10%)
200	150	20.0	220	21000 x (1±10%)

Nominal Voltage VAC	Pick-up Voltage VAC	Drop-out Voltage VAC	Max. Voltage VAC*	Coil Resistance Ω
6	4.80	0.90	6.6	18.8 x (1±10%)
12	9.60	1.80	13.2	75 x (1±10%)
24	19.2	3.60	26.4	300 x (1±10%)
48	38.4	7.20	52.8	1200 x (1±10%)
120	96.0	18.0	132	5200 x (1±10%)
220/240	176	33.0	242	20800 x (1±10%)

Notes: * Maximum voltage refers to the maximum voltage which relay coil could endure in a short period of time.

SAFETY APPROVAL RATINGS

UL/CUL	AgSnO ₂	30A 277VAC 1.5HP 120VAC 3HP 240VAC 10A 120VAC Tungsten
	AgCdO	30A 277VAC 1.5HP 120VAC 3HP 240VAC 10A 120VAC Tungsten TV-10 120VAC
TÜV		27A 240VAC COSφ=0.8 25A 240VAC COSφ=0.4 25A 240VAC COSφ=1

- Notes: 1) All values unspecified are at room temperature.
2) Only typical loads are listed above. Other load specifications can be available upon request.



HONGFA RELAY

ISO9001, ISO/TS16949, ISO14001, OHSAS18001, IECQ QC 080000 CERTIFIED

ORDERING INFORMATION

HF116F-1 / 012 D A -1H T F W C (XXX)	
Type	
Coil voltage	DC: 3VDC to 200VDC AC: 6VAC to 220VAC
Coil voltage form	D: DC A: AC
Mounting	A: Mount P: PCB F: Flanged
Contact arrangement	1H:1 Form A 2H: 2 Form A
Contact material	T: AgSnO ₂ Nil: AgCdO
Insulation standard	F: Class F Nil: Class B
Contact Gap	W: 3.0mm Nil: Standard
Capacitor	C: With Capacitor(Only for AC) Nil: Without Capacitor
Special code ³⁾	XXX: Customer special requirement Nil: Standard

Notes: 1) Water cleaning or surface process is not suggested after the dust-protected relays are assembled on PCB.
 2) Dust-protected relays can not be used in the environment with pollutants like H₂S, SO₂, NO₂, dust, etc.
 3) The customer special requirement express as special code after evaluating by Hongfa.

OUTLINE DIMENSIONS, WIRING DIAGRAM AND PC BOARD LAYOUT

Unit: mm

Outline Dimensions

HF116F-1/□□□□ -□ -P-1H-□

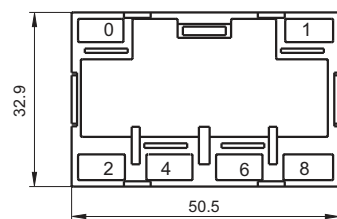

(Bottom view)

HF116F-1/□□□□ -□ -P-2H-□

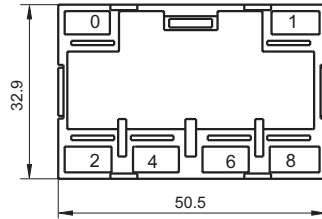

(Bottom view)

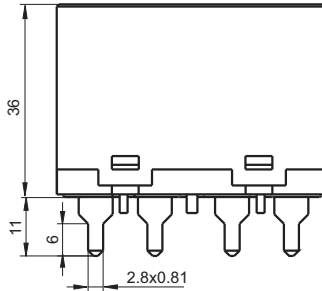
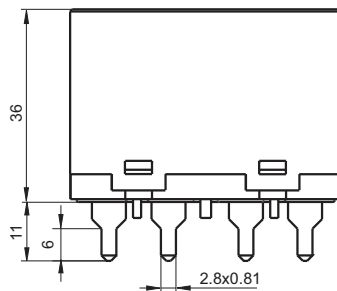

PCB Layout (Bottom view)

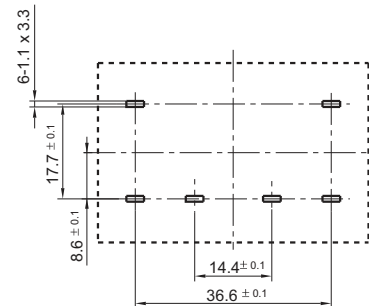

Outline Dimensions

HF116F-1/□□□□-□-F-1H-□

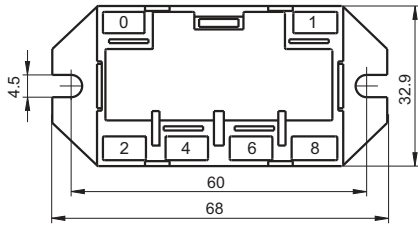

(Bottom view)

HF116F-1/□□□□-□-F-2H-□

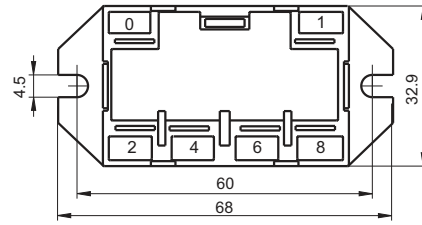

(Bottom view)

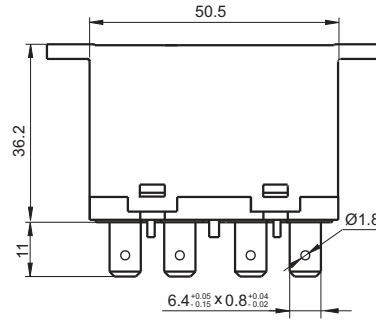
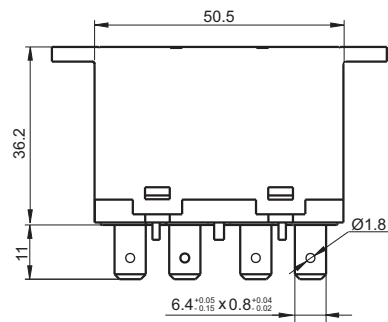

HF116F-1/□□□□-□-A-1H-□

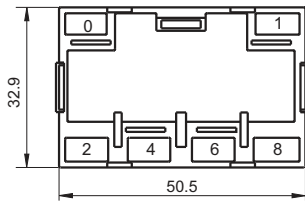

(Bottom view)

HF116F-1/□□□□-□-A-2H-□

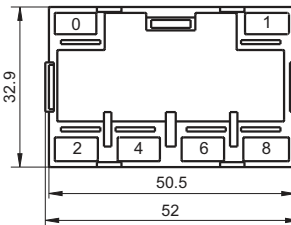

(Bottom view)

Mounting Holes

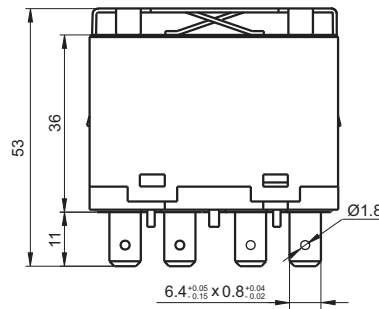
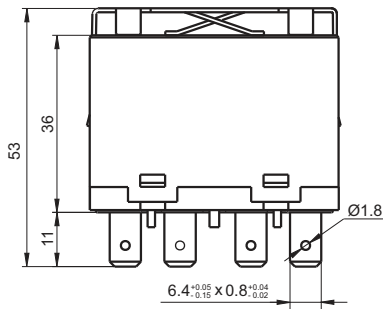
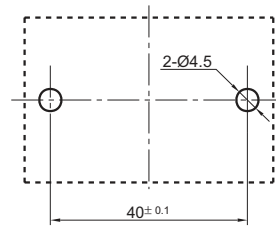

- Remark: 1) In case of no tolerance shown in outline dimension: outline dimension ≤ 1 mm, tolerance should be ± 0.2 mm; outline dimension > 1 mm and ≤ 5 mm, tolerance should be ± 0.3 mm; outline dimension > 5 mm, tolerance should be ± 0.4 mm.
 2) The tolerance without indicating for PCB layout is always ± 0.1 mm.

Wiring Diagram
(Bottom view)

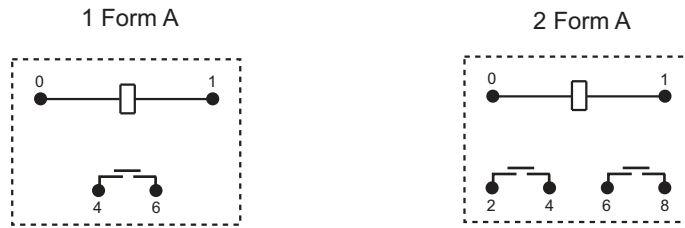

Coil Inner Circuit

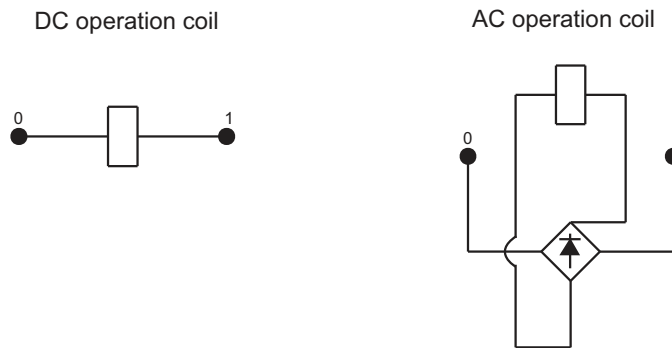

CHARACTERISTIC CURVES

MAXIMUM SWITCHING POWER

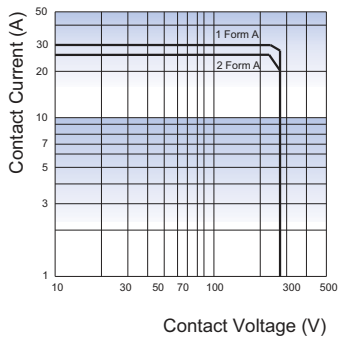

ENDURANCE CURVE

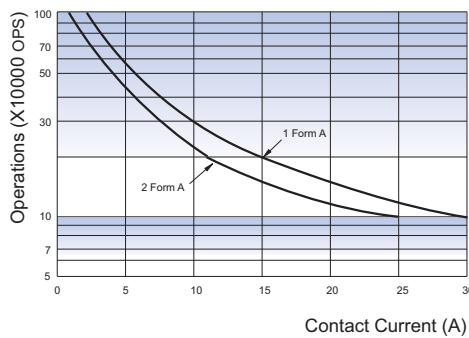

COIL TEMPERATURE RISE

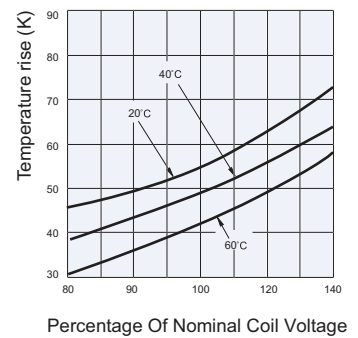

Test conditions:
250VAC, Resistive load, Room temp.,
1s on 9s off

Disclaimer

The specification is for reference only. See to "Terminology and Guidelines" for more information. Specifications subject to change without notice. We could not evaluate all the performance and all the parameters for every possible application. Thus the user should be in a right position to choose the suitable product for their own application. If there is any query, please contact Hongfa for the technical service. However, it is the user's responsibility to determine which product should be used only.

HF116F-2

MINIATURE HIGH POWER RELAY



File No.:E134517



File No.:R50154722



File No.:CQC09002031231(DC type)



Features

- 30A switching capability
- 4kV dielectric strength (between coil and contacts)
- 3mm contact gap available
- UL insulation system: Class F available
- Environmental friendly product (RoHS compliant)
- Outline Dimensions: (51.5 x 34.9 x 36.0) mm

CONTACT DATA

Contact arrangement	1A	2A
Contact resistance	100mΩ max.(at 1A 24VDC)	
Contact material	AgSnO ₂ , AgCdO	
Contact rating (Res. load)	30A 240VAC 30A 277VAC	25A 240VAC 25A 277VAC
Max. switching voltage	277VAC	
Max. switching current	30A	25A
Max. switching power	8310VA	6925VA
Mechanical endurance	1 x 10 ⁷ OPS	
Electrical endurance	1H,1HT type: 1 x 10 ⁵ OPS (30A 240VAC, Resistive load, Room temp., 1s on 9s off) 2H,2HT type: 1 x 10 ³ OPS (25A 240VAC, Resistive load, Room temp., 1s on 9s off)	

CHARACTERISTICS

Insulation resistance	1000MΩ (at 500VDC)	
Dielectric strength	Between coil & contacts	4000VAC 1min
	Between open contacts	2000VAC 1min
Operate time (at nomi. vot.)	30ms max.(DC type)	
Release time (at nomi. vot.)	30ms max.(DC type)	
Shock resistance	Functional	Standard:98m/s ² Pulse width 11ms W type:98m/s ² Pulse width 6ms
	Destructive	980m/s ² Pulse width 6ms
Vibration resistance	Standard:10H to 55Hz 1.5mm DA W type:10H to 55Hz 1.0mm DA	
Ambient temperature	-55°C to 70°C	
Humidity	5% to 85% RH	
Termination	PCB, QC, Screw	
Unit weight	Approx. 120g	
Construction	Plastic sealed, Flux proofed	

- Notes:** 1) The data shown above are initial values.
2) Please find coil temperature curve in the characteristic curves below.
3) For the plastic sealed type, please open two vent holes after installing relay (or cleansing PCB board) in order to increase the relay reliability.
4) UL insulation system: Class F, Class B.

COIL

Coil power	DC type: Approx. 1.9W; AC type: Approx. 2.7VA
------------	--

COIL DATA

at 23°C

Nominal Voltage VDC	Pick-up Voltage VDC max.	Drop-out Voltage VDC min.	Max. Voltage VDC*	Coil Resistance Ω
3	2.25	0.3	3.3	4.7 x (1±10%)
6	4.50	0.6	6.6	18.8 x (1±10%)
12	9.00	1.2	13.2	75 x (1±10%)
24	18.0	2.4	26.4	300 x (1±10%)
48	36.0	4.8	52.8	1200 x (1±10%)
100	75.0	10.0	110	5200 x (1±10%)
110	82.5	11.0	121	6300 x (1±10%)
200	150	20.0	220	21000 x (1±10%)

Nominal Voltage VAC	Pick-up Voltage VAC max.	Drop-out Voltage VAC min.	Max. Voltage VAC*	Coil Resistance Ω
6	4.80	0.90	6.6	18.8 x (1±10%)
12	9.60	1.80	13.2	75 x (1±10%)
24	19.2	3.60	26.4	300 x (1±10%)
48	38.4	7.20	52.8	1200 x (1±10%)
120	96.0	18.0	132	5200 x (1±10%)
220/240	176	33.0	242	20800 x (1±10%)

Notes: * Maximum voltage refers to the maximum voltage which relay coil could endure in a short period of time.

SAFETY APPROVAL RATINGS

UL/CUL	AgSnO ₂	30A 277VAC 1.5HP 120VAC 3HP 240VAC 10A 120VAC Tungsten
	AgCdO	30A 277VAC 1.5HP 120VAC 3HP 240VAC 10A 120VAC Tungsten TV-10 120VAC
TÜV		27A 240VAC COSØ = 0.8 25A 240VAC COSØ = 0.4 25A 240VAC COSØ = 1

- Notes:** 1) All values unspecified are at room temperature.
2) Only typical loads are listed above. Other load specifications can be available upon request.



HONGFA RELAY

ISO9001, ISO/TS16949, ISO14001, OHSAS18001, IECQ QC 080000 CERTIFIED

ORDERING INFORMATION

HF116F-2 / 012 D L -1H S T F W (XXX)		
Type		
Coil voltage	DC: 3VDC to 200VDC AC: 6VAC to 220VAC	
Coil input	D: DC	A: AC
Mounting	P: PCB	L: Screw
Contact arrangement	1H: 1 Form A	2H: 2 Form A
Construction ¹⁾²⁾	S: Plastic sealed	Nil: Flux proofed
Contact material ³⁾	T: AgSnO ₂	Nil: AgCdO
Insulation standard	F: Class F	Nil: Class B
Contact Gap	W: 3.0mm	Nil: Standard
Special code ⁴⁾	XXX: Customer special requirement	Nil: Standard

- Notes: 1) We recommend flux proofed types for a clean environment (free from contaminations like H₂S, SO₂, NO₂, dust, etc.). We suggest to choose plastic sealed types and validate it in real application for an unclean environment (with contaminations like H₂S, SO₂, NO₂, dust, etc).
- 2) Contact is recommended for suitable condition and specifications if water cleaning or surface process is involved in assembling relays on PCB.
- 3) For the applications of motor load, capacitive load and high inrush current, AgSnO₂ contact material is recommended. For the applications of resistive load or low inductive load, AgCdO contact material is recommended.
- 4) The customer special requirement express as special code after evaluating by Hongfa.

OUTLINE DIMENSIONS, WIRING DIAGRAM AND PC BOARD LAYOUT

Unit: mm

Outline Dimensions

Mounting Holes

HF116F-2/□□□□ -□ -L-1H-□

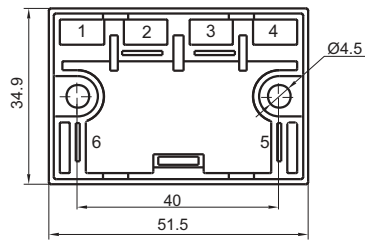

(Bottom view)

HF116F-2/□□□□ -□ -L-2H-□

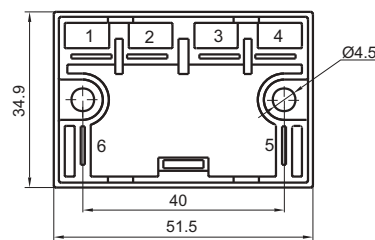

(Bottom view)

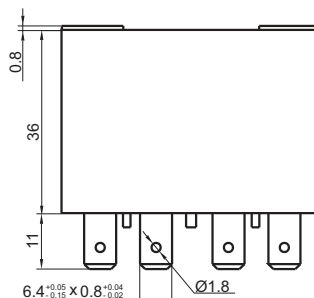
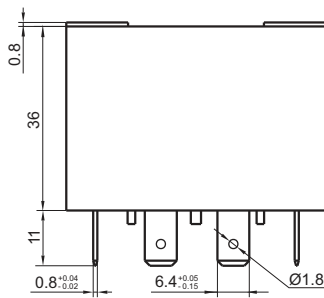
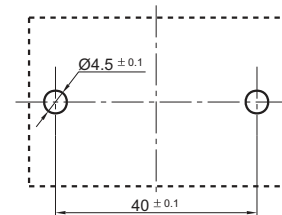

OUTLINE DIMENSIONS, WIRING DIAGRAM AND PC BOARD LAYOUT

Unit: mm

Outline Dimensions

PCB Layout (Bottom view)

HF116F-2/□□□□-□-P-1H-□

HF116F-2/□□□□-□-P-2H-□

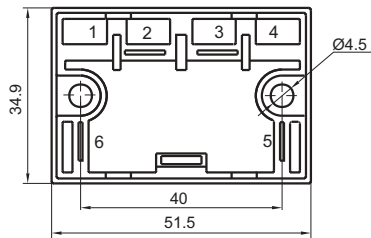

(Bottom view)

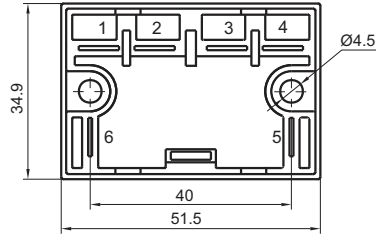

(Bottom view)

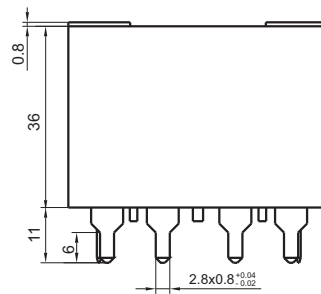
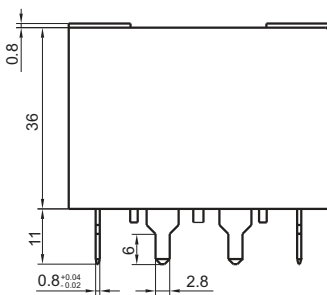
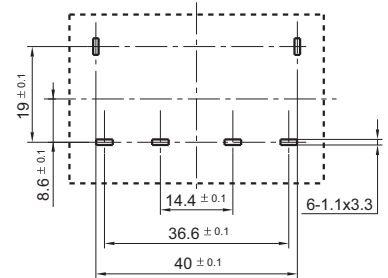

Remark: 1) In case of no tolerance shown in outline dimension: outline dimension ≤ 1 mm, tolerance should be ± 0.2 mm; outline dimension > 1 mm and ≤ 5 mm, tolerance should be ± 0.3 mm; outline dimension > 5 mm, tolerance should be ± 0.4 mm.
2) The tolerance without indicating for PCB layout is always ± 0.1 mm.

Wiring Diagram (Bottom view)

1 Form A

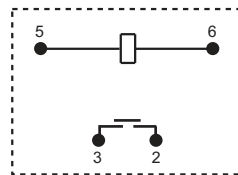

2 Form A

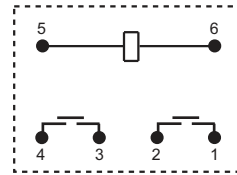

Coil Inner Circuit

DC operation coil

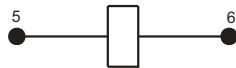

AC operation coil

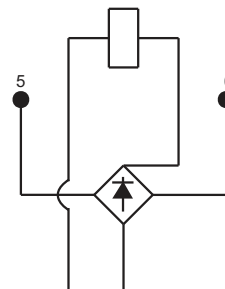

CHARACTERISTIC CURVES

MAXIMUM SWITCHING POWER

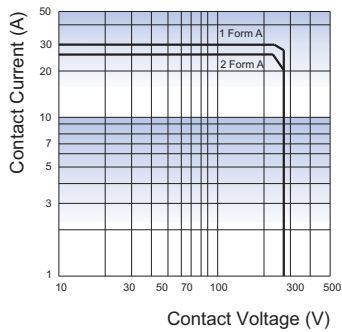

ENDURANCE CURVE

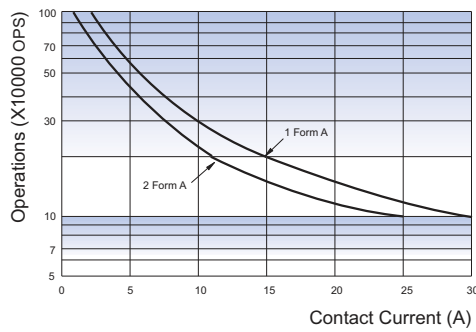

Test conditions:
250VAC, Resistive load, Flux proofed,
Room temp., 1s on 9s off

COIL TEMPERATURE RISE

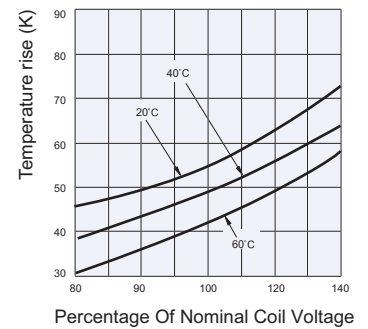

Disclaimer

The specification is for reference only. See to "Terminology and Guidelines" for more information. Specifications subject to change without notice. We could not evaluate all the performance and all the parameters for every possible application. Thus the user should be in a right position to choose the suitable product for their own application. If there is any query, please contact Hongfa for the technical service. However, it is the user's responsibility to determine which product should be used only.

HF116F-3

MINIATURE HIGH POWER RELAY



File No.:E134517



File No.:R50154722



File No.:CQC09002031231(DC type)



Features

- 30A switching capability
- 4kV dielectric strength (between coil and contacts)
- 3mm contact gap available
- UL insulation system: Class F available
- Environmental friendly product (RoHS compliant)
- Outline Dimensions: (50.5 x 32.9 x 51.0) mm

CONTACT DATA

Contact arrangement	1A	2A
Contact resistance	100mΩ max.(at 1A 24VDC)	
Contact material	AgSnO ₂ , AgCdO	
Contact rating (Res. load)	30A 240VAC 30A 277VAC	25A 240VAC 25A 277VAC
Max. switching voltage	277VAC	
Max. switching current	30A	25A
Max. switching power	8310VA	6925VA
Mechanical endurance	1 x 10 ⁷ OPS	
Electrical endurance	1H, 1HT type: 1 x 10 ⁵ OPS (30A 240VAC, Resistive load, Room temp., 1s on 9s off) 2H, 2HT type: 1 x 10 ⁵ OPS (25A 240VAC, Resistive load, Room temp., 1s on 9s off)	

CHARACTERISTICS

Insulation resistance	1000MΩ (at 500VDC)	
Dielectric strength	Between coil & contacts	4000VAC 1min
	Between open contacts	2000VAC 1min
Operate time (at nomi. volt.)	30ms max.(DC type)	
Release time (at nomi. volt.)	30ms max.(DC type)	
Shock resistance	Functional	Standard:98m/s ² Pulse width 11ms W type:98m/s ² Pulse width 6ms
	Destructive	980m/s ² Pulse width 6ms
Vibration resistance	Standard:10H to 55Hz 1.5mm DA W type:10H to 55Hz 1.0mm DA	
Ambient temperature	-55°C to 70°C	
Humidity	5% to 85% RH	
Termination	PCB, QC, Screw	
Unit weight	Approx.120g	
Construction	Dust protected	

Notes: 1) The data shown above are initial values.
2) Please find coil temperature curve in the characteristic curves below.
3) UL insulation system: Class F, Class B.

COIL

Coil power	DC type: Approx. 1.9W; AC type: Approx. 2.7VA
------------	--

COIL DATA

at 23°C

Nominal Voltage VDC	Pick-up Voltage VDC max.	Drop-out Voltage VDC min.	Max. Voltage VDC*	Coil Resistance Ω
3	2.25	0.3	3.3	4.7 x (1±10%)
6	4.50	0.6	6.6	18.8 x (1±10%)
12	9.00	1.2	13.2	75 x (1±10%)
24	18.0	2.4	26.4	300 x (1±10%)
48	36.0	4.8	52.8	1200 x (1±10%)
100	75.0	10.0	110	5200 x (1±10%)
110	82.5	11.0	121	6300 x (1±10%)
200	150	20.0	220	21000 x (1±10%)

Nominal Voltage VAC	Pick-up Voltage VAC max.	Drop-out Voltage VAC min.	Max. Voltage VAC*	Coil Resistance Ω
6	4.80	0.90	6.6	18.8 x (1±10%)
12	9.60	1.80	13.2	75 x (1±10%)
24	19.2	3.60	26.4	300 x (1±10%)
48	38.4	7.20	52.8	1200 x (1±10%)
120	96.0	18.0	132	5200 x (1±10%)
220/240	176	33.0	242	20800 x (1±10%)

Notes: * Maximum voltage refers to the maximum voltage which relay coil could endure in a short period of time.

SAFETY APPROVAL RATINGS

UL/CUL	AgSnO ₂	30A 277VAC 1.5HP 120VAC, 3HP 240VAC 10A 120VAC Tungsten
	AgCdO	30A 277VAC 1.5HP 120VAC, 3HP 240VAC 10A 120VAC Tungsten
TÜV		TV-10 120VAC
		27A 240VAC COSØ =0.8
		25A 240VAC COSØ =0.4 25A 240VAC COSØ =1

Notes: 1) All values unspecified are at room temperature.
2) Only typical loads are listed above. Other load specifications can be available upon request.



HONGFA RELAY

ISO9001, ISO/TS16949, ISO14001, OHSAS18001, IECQ QC 080000 CERTIFIED

ORDERING INFORMATION

Type		HF116F-3 / 012 D F -1H T F W C (XXX)	
Coil voltage	DC: 3VDC to 200VDC AC: 6VAC to 240VAC		
Coil voltage form	D: DC	A: AC	
Mouting	A: Mount	F: Flanged	
Contact arrangement	1H: 1 Form A	2H: 2 Form A	
Contact material	T: AgSnO ₂	Nil: AgCdO	
Insulation standard	F: Class F	Nil: Class B	
Contact Gap	W: 3.0mm	Nil: Standard	
Capacitor	C: With Capacitor(Only for AC)	Nil: Without Capacitor	
Special code ³⁾	XXX: Customer special requirement	Nil: Standard	

Notes: 1) Water cleaning or surface process is not suggested after the dust-protected relays are assembled on PCB.

2) dust-protected relays can not be used in the environment with pollutants like H₂S, SO₂, NO₂, dust, etc.

3) The customer special requirement express as special code after evaluating by Hongfa.

OUTLINE DIMENSIONS, WIRING DIAGRAM AND PC BOARD LAYOUT

Unit: mm

Outline Dimensions

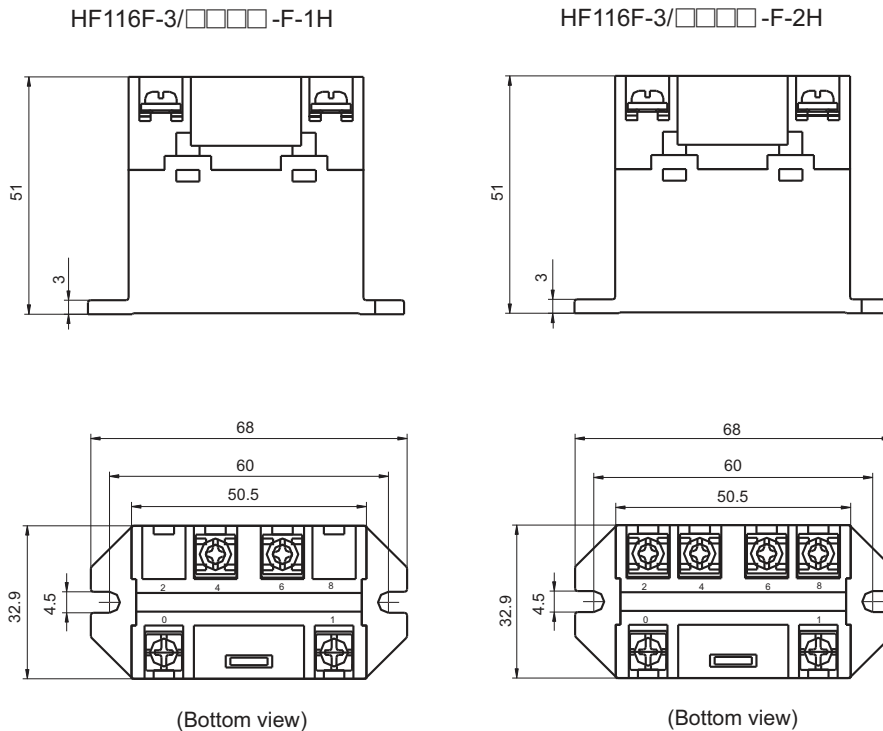

Outline Dimensions

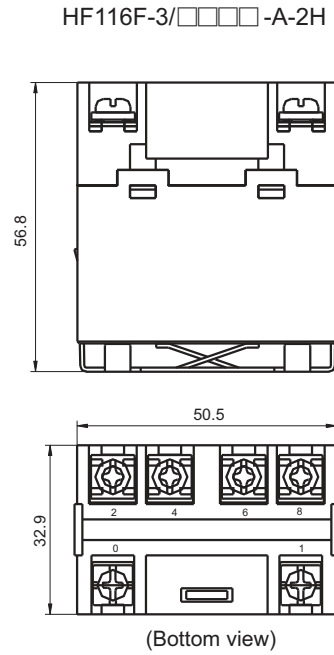
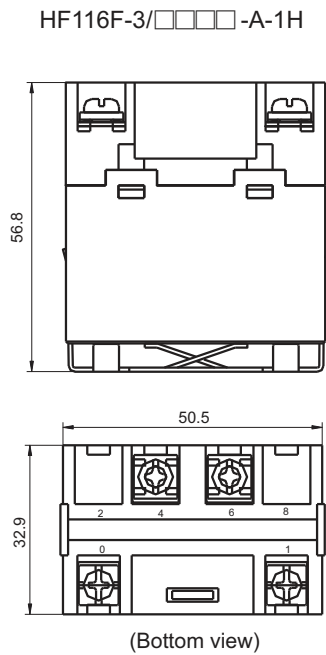

Remark: In case of no tolerance shown in outline dimension: outline dimension ≤ 1 mm, tolerance should be ± 0.2 mm; outline dimension > 1 mm and ≤ 5 mm, tolerance should be ± 0.3 mm; outline dimension > 5 mm, tolerance should be ± 0.4 mm.

Wiring Diagram
(Bottom view)

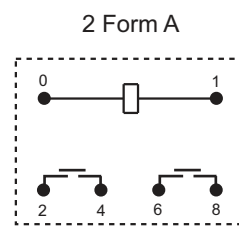
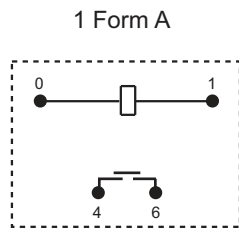

Coil Inner Circuit

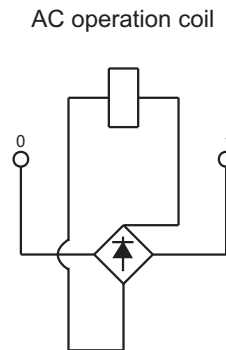
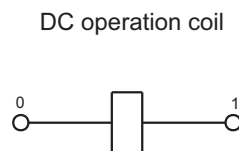

CHARACTERISTIC CURVES

MAXIMUM SWITCHING POWER

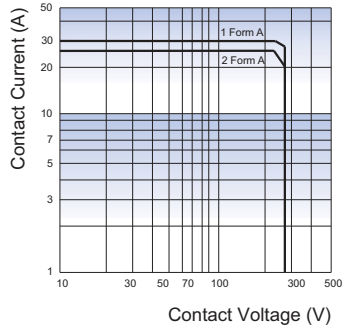

ENDURANCE CURVE

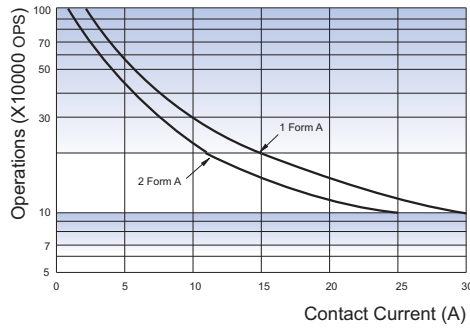

COIL TEMPERATURE RISE

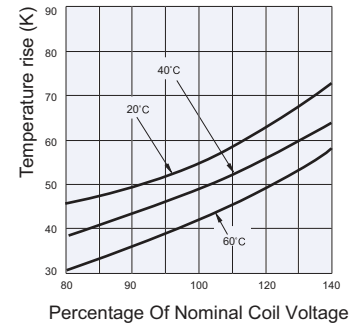

Test conditions:

250VAC, Resistive load,
Room temp., 1s on 9s off

Disclaimer

The specification is for reference only. See to "Terminology and Guidelines" for more information. Specifications subject to change without notice. We could not evaluate all the performance and all the parameters for every possible application. Thus the user should be in a right position to choose the suitable product for their own application. If there is any query, please contact Hongfa for the technical service. However, it is the user's responsibility to determine which product should be used only.

HF116F-G

SOLAR RELAY



File No.:E134517



File No.:R50154722



Features

- 50A switching capability
- Applicable to inverter used for photovoltaic power generation systems
- 4kV dielectric strength(between coil and contacts)
- 3mm contact gap
(compliant to European Photovoltaic Standard VDE0126, compliant to IEC 62109-2-2011)
- 1A and 2A configuration available
- UL insulation system: Class F
- Environmental friendly product (RoHS compliant)
- Outline Dimensions: G1:(50.5 x 32.9 x 36.0) mm
G2:(51.5 x 34.9 x 36.0) mm
G3:(51.5 x 34.9 x 36.0) mm

CONTACT DATA

Contact arrangement	1A, 2A
Contact resistance	10mΩ max.(at 10A 13.5VDC)
Contact material	AgSnO ₂ , AgNi
Contact rating (Res. load)	50A 277VAC
Max. switching voltage	277VAC
Max. switching current	55A
Max. switching power	15235VA
Mechanical endurance	1 x 10 ⁶ OPS
Electrical endurance	3 x 10 ⁴ OPS (50A 277VAC, at room temp. 1s on 9s off)

COIL

Coil power	Approx. 3.2W
Holding voltage	60%~120%U _N (at 23°C) 70%~95%U _N (at 85°C)

Notes: 1)The coil holding voltage is the voltage applied to coil 200ms after the rated voltage.

2)To avoid overheating and burning, the coil can not be consistently applied to with voltage larger than maximum holding voltage.

CHARACTERISTICS

Insulation resistance	1000MΩ (at 500VDC)	
Dielectric strength	Between open contacts	2000VAC 1min
	Between coil & contacts	4000VAC 1min
	Between contact sets	2000VAC 1min
Surge Voltage	6kV (1.2/50μs)	
Operate time (at nomi. volt.)	30ms max.	
Release time (at nomi. volt.)	30ms max.	
Shock resistance	Functional	98m/s ²
	Destructive	980m/s ²
Vibration resistance*	Functional	10Hz to 55Hz 1.5mm DA
	Destructive	10Hz to 55Hz 1.5mm DA
Humidity	5% to 85% RH	
Ambient temperature	-40°C to 85°C	
Termination ²⁾	PCB	
Unit weight	Approx. 120g	
Construction	G1: Dust protected; G2, G3: Flux proofed	

Notes: 1) The data shown above are initial values.

2) It does not allow using quick-connect terminations.

3)*Index is not in relay width direction.

COIL DATA

at 23°C

Nominal Voltage VDC	Pick-up Voltage VDC max.	Drop-out Voltage VDC min.	Max. Voltage VDC *	Coil Resistance Ω
3	2.25	0.3	3.3	2.8 x (1±10%)
6	4.50	0.6	6.6	11.3 x (1±10%)
9	6.75	0.9	9.9	25 x (1±10%)
12	9.00	1.2	13.2	45 x (1±10%)
24	18.0	2.4	26.4	180 x (1±10%)
48	36.0	4.8	52.8	720 x (1±10%)

Notes: *Maximun voltage refers to the maximun voltage which relay coil could endure in a short period of time.



HONGFA RELAY

ISO9001, ISO/TS16949, ISO14001, OHSAS18001, IECQ QC 080000 CERTIFIED

ORDERING INFORMATION

HF116F-G1/		12	-1H	T	F	(XXX)
Type	G1: Type 1 G2: Type 2 G3: Type 3					
Coil voltage	3, 6, 9, 12, 24, 48VDC					
Contact arrangement	1H: 1 Form A 2H: 2 Form A					
Contact material	T: AgSnO ₂ Nil: AgNi					
Insulation standard	F: Class F					
Special code ¹⁾	XXX: Customer special requirement		Nil: Standard			

Notes: 1) The customer special requirement express as special code after evaluating by Hongfa.

OUTLINE DIMENSIONS, WIRING DIAGRAM AND PC BOARD LAYOUT

Unit: mm

Outline Dimensions

PCB Layout
(Bottom view)

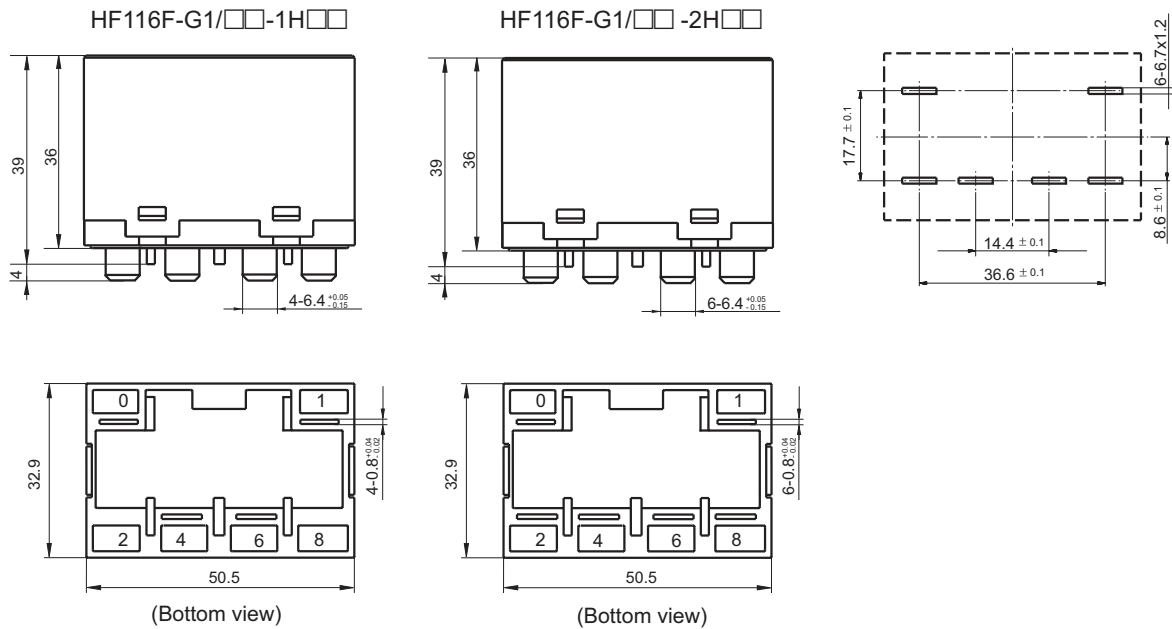

OUTLINE DIMENSIONS, WIRING DIAGRAM AND PC BOARD LAYOUT

Unit: mm

Outline Dimensions

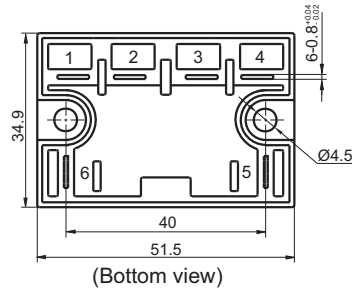
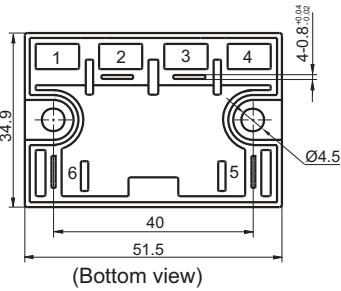
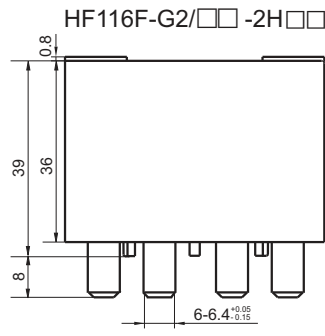
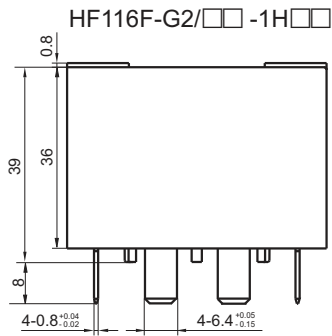

PCB Layout (Bottom view)

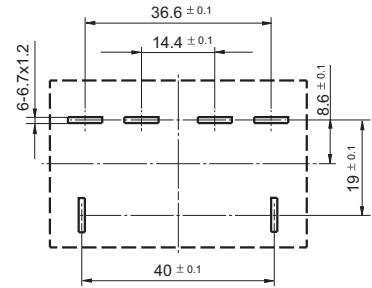

Outline Dimensions

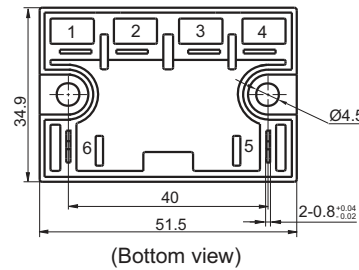
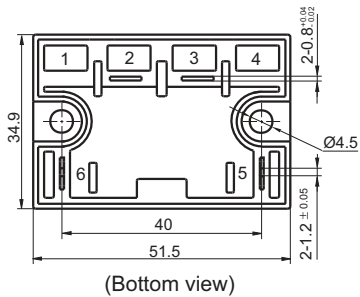
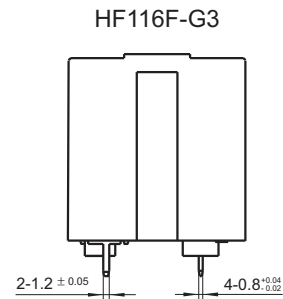
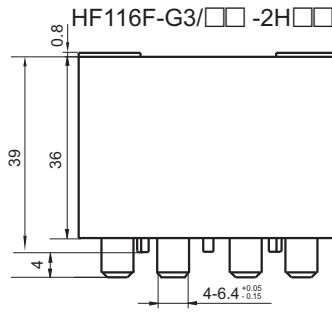
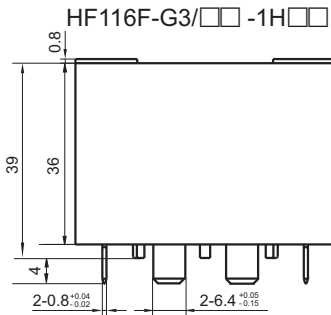

PCB Layout (Bottom view)

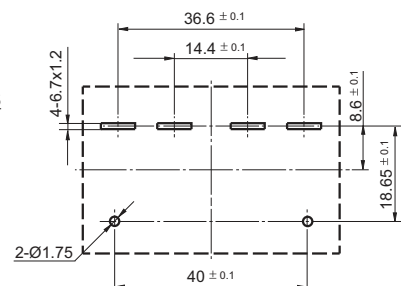

- Remark: 1) In case of no tolerance shown in outline dimension: outline dimension ≤ 1mm, tolerance should be ±0.2mm; outline dimension > 1mm and ≤ 5mm, tolerance should be ±0.3mm; outline dimension > 5mm, tolerance should be ±0.4mm.
 2) The tolerance without indicating for PCB layout is always ±0.1mm.

Wiring Diagram
(Bottom View)

G1 Type

1 Form A

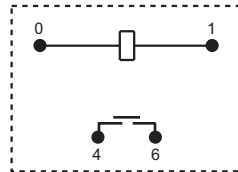

2 Form A

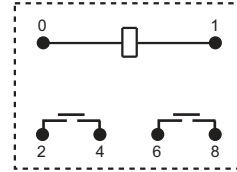

G1, G3 Type

1 Form A

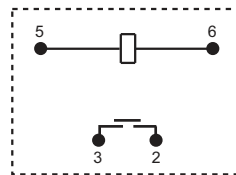

2 Form A

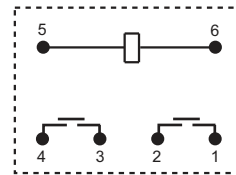

Disclaimer

The specification is for reference only. See to "Terminology and Guidelines" for more information. Specifications subject to change without notice. We could not evaluate all the performance and all the parameters for every possible application. Thus the user should be in a right position to choose the suitable product for their own application. If there is any query, please contact Hongfa for the technical service. However, it is the user's responsibility to determine which product should be used only.

HF116F-80

HIGH POWER RELAY



File No.:E134517



File No.:R50154722



Features

- 80A switching capability
- Applicable to solar photovoltaic inverter
- Applicable to UPS
- 3mm contact gap
(compliant to European Photovoltaic Standard VDE0126, compliant to IEC 62109-2-2011)
- 4kV dielectric strength(between coil and contacts)
- UL insulation system: Class F
- Environmental friendly product (RoHS compliant)
- Outline Dimensions: (50.5 x 32.9 x 36) mm

CONTACT DATA

Contact arrangement	1A
Contact resistance	10mΩ max.(at 10A 13.5VDC)
Contact material	AgSnO ₂ , AgNi
Contact rating (Res. load)	80A 250VAC
Max. switching voltage	277VAC
Max. switching current	90A
Max. load current	100A 15min at room temp.
Max. switching power	24930VA
Mechanical endurance	1 x 10 ⁶ OPS
Electrical endurance	6 x 10 ³ OPS
	(80A 250VAC, at 85°C, 1s on 9s off)
	6 x 10 ³ OPS (80A 60VDC, at 85°C, 1s on 9s off)

COIL

Coil power	Approx. 3.2W
Holding voltage	60%~120%U _N (at 23°C)
	70%~95%U _N (at 85°C)

- Notes:** 1)The coil holding voltage is the voltage applied to coil 200ms after the rated voltage.
2)To avoid overheating and burning, the coil can not be consistently applied to with voltage larger than maximum holding voltage.

CHARACTERISTICS

Insulation resistance	1000MΩ (at 500VDC)	
Dielectric strength	Between open contacts	2000VAC 1min
	Between coil & contacts	4000VAC 1min
Surge Voltage	6kV (1.2/50μs)	
Operate time (at nomi. volt.)	30ms max.	
Release time (at nomi. volt.)	30ms max.	
Shock resistance	Functional	98m/s ²
	Destructive	980m/s ²
Vibration resistance*	10Hz to 55Hz 1.5mm DA	
Humidity	5% to 85% RH	
Ambient temperature	-40°C to 85°C	
Termination ²⁾	PCB	
Unit weight	Approx. 120g	
Construction	Dust protected	

- Notes:** 1) The data shown above are initial values;
2) It does not allow using quick-connect terminations.
3)*Index is not in relay width direction.

COIL DATA

at 23°C

Nominal Voltage VDC	Pick-up Voltage VDC max.	Drop-out Voltage VDC min.	Max. Voltage VDC *	Coil Resistance Ω
3	2.25	0.3	3.3	2.8 x (1±10%)
6	4.50	0.6	6.6	11.3 x (1±10%)
9	6.75	0.9	9.9	25 x (1±10%)
12	9.00	1.2	13.2	45 x (1±10%)
24	18.0	2.4	26.4	180 x (1±10%)
48	36.0	4.8	52.8	720 x (1±10%)

- Notes:** *Maximun voltage refers to the maximun voltage which relay coil could endure in a short period of time.



HONGFA RELAY

ISO9001, ISO/TS16949, ISO14001, OHSAS18001, IECQ QC 080000 CERTIFIED

ORDERING INFORMATION

Type	HF116F-80/	12	-1H	T	F	(XXX)
Coil voltage	3, 6, 9, 12, 24, 48VDC					
Contact arrangement	1H:1 Form A					
Contact material	T: AgSnO ₂		Nil: AgNi			
Insulation standard	F: Class F					
Special code ¹⁾	XXX: Customer special requirement		Nil: Standard			

Notes: 1) The customer special requirement express as special code after evaluating by Hongfa. e.g.(335) stands for product in accordance to IEC 60335-1 (GWT).

OUTLINE DIMENSIONS, WIRING DIAGRAM AND PC BOARD LAYOUT

Unit: mm

Outline Dimensions

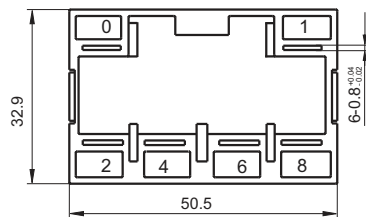
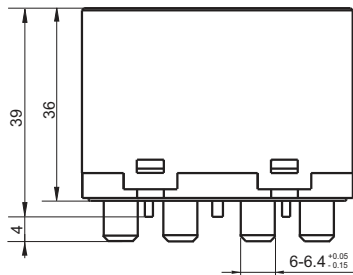

(Bottom view)

PCB Layout

(Bottom view)

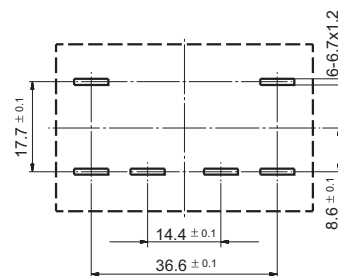

Wiring Diagram

(Bottom view)

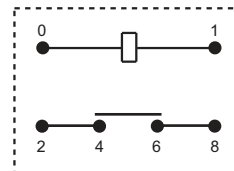

Remark: 1) In case of no tolerance shown in outline dimension: outline dimension $\leq 1\text{mm}$, tolerance should be $\pm 0.2\text{mm}$; outline dimension $> 1\text{mm}$ and $\leq 5\text{mm}$, tolerance should be $\pm 0.3\text{mm}$; outline dimension $> 5\text{mm}$, tolerance should be $\pm 0.4\text{mm}$.

2) The tolerance without indicating for PCB layout is always $\pm 0.1\text{mm}$.

Disclaimer

The specification is for reference only. See to "Terminology and Guidelines" for more information. Specifications subject to change without notice. We could not evaluate all the performance and all the parameters for every possible application. Thus the user should be in a right position to choose the suitable product for their own application. If there is any query, please contact Hongfa for the technical service. However, it is the user's responsibility to determine which product should be used only.

HF92F

MINIATURE INTERMEDIATE POWER RELAY



File No.:E134517



File No.:40016109



File No.:CQC09002037814 (DC type)

CQC14002114447 (AC type)



Features

- 30A switching capability
- Creepage distance: 8mm
- 4kV dielectric strength (between coil and contacts)
- UL insulation system: Class F
- Plastic sealed and dust protected types available
- PCB & QC layouts available
- Environmental friendly product (RoHS compliant)
- Outline Dimensions: (52.0 x 33.7 x 26.7) mm

CONTACT DATA

Contact arrangement	2A, 2C
Contact resistance	50mΩ max.(at 1A 24VDC)
Contact material	AgSnO ₂ , AgCdO
Contact rating (Res. load)	NO: 30A 250VAC; 30A 277VAC NC: 3A 250VAC; 3A 277VAC
Max. switching voltage	277VAC
Max. switching current	30A
Max. switching power	8310VA
Mechanical endurance	5 x 10 ⁶ OPS
Electrical endurance	1 x 10 ⁵ OPS (NO: 30A 277VAC, Resistive load, Room temp., 1s on 9s off) 1 x 10 ⁵ OPS (NC: 3A 277VAC, Resistive load, Room temp., 1s on 9s off)

CHARACTERISTICS

Insulation resistance	1000MΩ (at 500VDC)	
Dielectric strength	Between coil & contacts	4000VAC 1min
	Between open contacts	1500VAC 1min
	Between contact poles	2000VAC 1min
Surge voltage (between coil & contacts)	10kV (1.2/50μs)	
Operate time (at nomi. volt.)	DC type: 25ms max.	
Release time (at nomi. volt.)	DC type: 25ms max.	
Temperature rise (at nomi. volt.)	AC type:90K max. DC type:70K max.	
Shock resistance	Functional	98m/s ²
	Destructive	980m/s ²
Vibration resistance	10Hz to 55Hz 1.65mm DA	
Humidity	5% to 85% RH	
Ambient temperature	AC: -40°C to 65°C DC: -40°C to 85°C	
Termination	PCB, QC	
Unit weight	Approx. 86g	
Construction	Plastic sealed, Flux proofed	

Notes: The data shown above are initial values.

COIL

Coil power	DC type: Approx. 1.7W; AC type: Approx. 4.0VA
------------	--

COIL DATA

at 23°C

DC type

Coil Code	Nominal Voltage VDC	Pick-up Voltage VDC max.	Drop-out Voltage VDC min.	Max. Voltage VDC*	Coil Resistance Ω
005D	5	3.8	0.5	8.0	15.3x (1±10%)
006D	6	4.5	0.6	9.6	22x (1±10%)
012D	12	9	1.2	19.2	86x (1±10%)
024D	24	18	2.4	38.4	350x (1±10%)
048D	48	36	4.8	76.8	1390x (1±10%)
110D	110	82.5	11	176	7255x (1±10%)

AC type (at 50Hz)

Coil Code	Nominal Voltage VAC	Pick-up Voltage VAC max.	Drop-out Voltage VAC min.	Max. Voltage VAC*	Coil Resistance Ω
024A5	24	19.2	4.8	26.4	45x (1±10%)
120A5	120	96	24	132	1125x (1±10%)
208A5	208	166.4	41.6	229	3278x (1±10%)
220A5	220	176	44	242	3800x (1±10%)
240A5	240	192	48	264	4500x (1±10%)
277A5	277	221.6	55.4	305	5960x (1±10%)

AC type (at 60Hz)

Coil Code	Nominal Voltage VAC	Pick-up Voltage VAC max.	Drop-out Voltage VAC min.	Max. Voltage VAC*	Coil Resistance Ω
024A6	24	19.2	4.8	26.4	35.7x (1±10%)
120A6	120	96	24	132	830x (1±10%)
208A6	208	166.4	41.6	229	2600x (1±10%)
220A6	220	176	44	242	2870x (1±10%)
240A6	240	192	48	264	3800x (1±10%)
277A6	277	221.6	55.4	305	4700x (1±10%)



HONGFA RELAY

ISO9001, ISO/TS16949, ISO14001, OHSAS18001, IECQ QC 080000 CERTIFIED

COIL DATA

at 23°C

AC type (at 50Hz/60Hz)

Coil Code	Nominal Voltage VAC	Pick-up Voltage VAC max.		Drop-out Voltage VAC min.		Max. Voltage VDC*	Coil Resistance Ω
		50Hz	60Hz	50Hz	60Hz		
120A	120	88	96	22	24	132	950 x (1±10%)
208A	208	160	166.4	40	41.6	229	2841 x (1±10%)
240A	240	176	192	44	48	264	3800 x (1±10%)
277A	277	200	221.6	50	55.4	305	5485 x (1±10%)

Notes: * Maximum voltage refers to the maximum voltage which relay coil could endure in a short period of time.

SAFETY APPROVAL RATINGS

UL/CUL ¹⁾	NO	30A 277VAC 1HP 120VAC 2.5HP 240VAC 110 LRA/25.3 FLA 240VAC (DC type)
	NC	3A 277VAC
VDE ¹⁾ (AgSnO ₂)	NO	30A 250VAC 20A 250VAC
	NC	3A 250VAC

Notes: 1) UL certified loads are tested at 40°C. VDE certified loads are tested at 85°C (DC products) or 50°C (AC products).

2) Only typical loads are listed above. Other load specifications can be available upon request.

ORDERING INFORMATION

Type	HF92F	-012D	-2C	2	2	F	(XXX)
Coil Code	XXX D: DC type(5,6,12,24,48,110VDC) XXX A5: AC type 50Hz(24,120,208,220,240,277VAC) XXX A6: AC type 60Hz(24,120,208,220,240,277VAC) XXX A: AC type 50Hz/60Hz(120,208,240,277VAC)						
Contact arrangement	2A: 2 Form A	2C: 2 Form C					
Termination ¹⁾	1: PCB	2, 3: QC					
Contact material	1: AgSnO ₂	2: AgCdO					
Construction ²⁾	S: Plastic sealed	F: Flux proofed					
Special code ³⁾	XXX: Customer special requirement		Nil: Standard				

Notes: 1) For QC terminals, no soldering or washing is allowed. For PCB terminals, please refer to us for soldering condition and part specification for necessary washing or surface processing after it is soldered to PCB.

2) We recommend dust protected types for a clean environment (free from contaminations like H₂S, SO₂, NO₂, dust, etc.).

We suggest to choose plastic sealed types and validate it in real application for an unclean environment (with contaminations like H₂S, SO₂, NO₂, dust, etc.).

3) The customer special requirement express as special code after evaluating by Hongfa.

Outline Dimensions

1 Type (PCB)

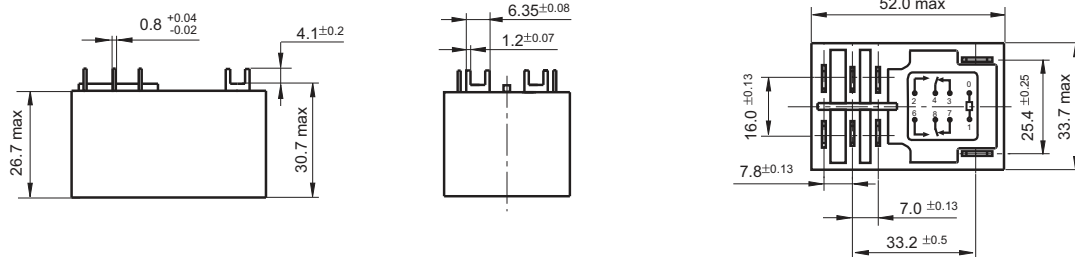

2 Type (QC)

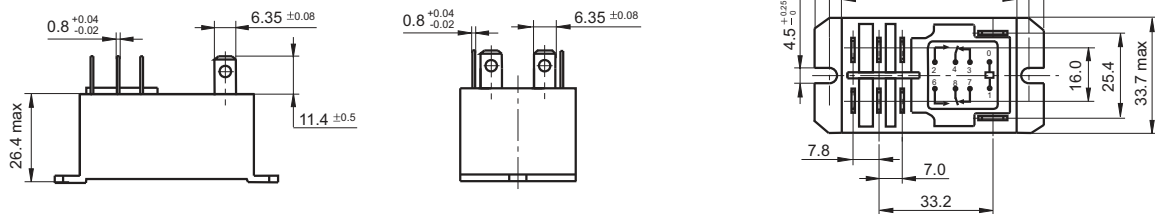

3 Type (QC)

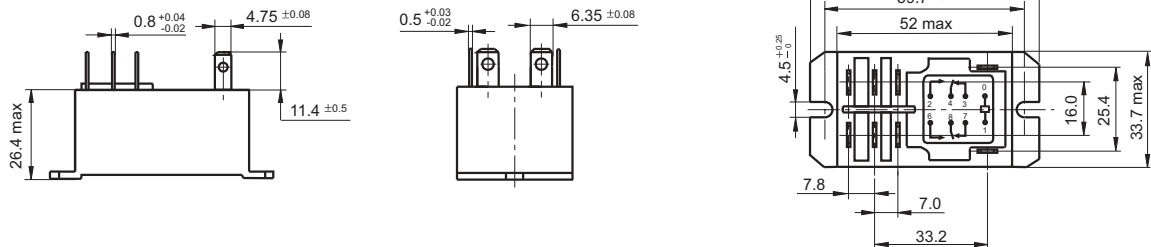

PCB Layout (Bottom view)

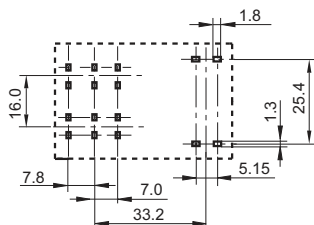

Wiring Diagram (Bottom view)

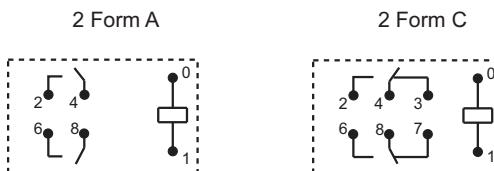

Remark: 1) In case of no tolerance shown in outline dimension: outline dimension ≤ 1mm, tolerance should be ±0.2mm; outline dimension > 1mm and ≤ 5mm, tolerance should be ±0.3mm; outline dimension > 5mm, tolerance should be ±0.4mm.
 2) The tolerance without indicating for PCB layout is always ±0.1mm.

CHARACTERISTIC CURVES

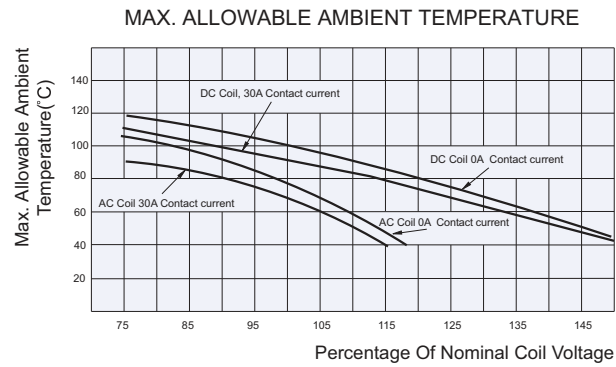

Disclaimer

The specification is for reference only. See to "Terminology and Guidelines" for more information. Specifications subject to change without notice. We could not evaluate all the performance and all the parameters for every possible application. Thus the user should be in a right position to choose the suitable product for their own application. If there is any query, please contact Hongfa for the technical service. However, it is the user's responsibility to determine which product should be used only.

HF84F

HIGH POWER RELAY



File No.:E134517 (AC type)



Features

- 16A switching capability
- 2.5kV dielectric strength (between coil and contacts)
- Panel mount types available
- Environmental friendly product (RoHS compliant)
- Outline Dimensions: (47.0 x 32.0 x 28.5)mm

CONTACT DATA

Contact arrangement	1A, 1B, 1C	
Contact resistance	50mΩ max.(at 1A 24VDC)	
Contact material	AgCe	
Contact rating (Res.load)	1A, 1C	1B
	16A 250VAC, Resistive load	8A 250VAC, General load
Max. switching voltage	250VAC	
Max. switching current	16A	
Max. switching power	4000VAC	
Mechanical endurance	1 x 10 ⁶ OPS	
Electrical endurance	7 type: 3 x 10 ⁴ OPS (8A 250VAC, General use, at 40°C, 1s on 9s off)	
	1, 4 type: 1 x 10 ⁵ OPS (16A 250VAC, Resistive load, at 65°C, 1s on 9s off)	

CHARACTERISTICS

Insulation resistance	500MΩ (at 500VDC)	
Dielectric strength	Between coil & contacts	2500VAC 1min
	Between open contacts	1000VAC 1min
Operate time (at nomi. volt.)	DC type: 25ms max.	
Release time (at nomi. volt.)	DC type: 25ms max.	
Temperature rise (at nomi. volt.)	90K max.	
Shock resistance (Functional)	147m/s ² 11ms	
Vibration resistance	10Hz to 55Hz 2.54mm DA	
Ambient temperature	-40°C to 65°C	
Humidity	5% to 85% RH	
Termination	QC	
Unit weight	Approx. 75g	
Construction	Dust protected	

Notes: 1) The data shown above are initial values.
2) UL insulation system: Class A

COIL

Coil power	DC type: 2.1W ; AC type: 3.5VA
------------	-----------------------------------

COIL DATA

at 23°C

Nominal Voltage VDC	Pick-up Voltage VDC max.	Drop-out Voltage VDC min.	Max. Voltage VDC *	Coil Resistance Ω
6	4.50	0.6	6.6	17.5 x (1±10%)
9	6.75	0.9	9.9	40 x (1±10%)
12	9.00	1.2	13.2	70 x (1±10%)
24	18.0	2.4	26.4	280 x (1±10%)
48	36.0	4.8	52.8	1120 x (1±10%)
120	90.0	12.0	132	7000 x (1±10%)

Nominal Voltage VAC	Pick-up Voltage VAC max.	Drop-out Voltage VAC min.	Max. Voltage VAC *	Coil Resistance Ω
6	5.1	1.2	6.6	4.8 x (1±10%)
12	10.2	2.4	13.2	19 x (1±10%)
24	20.4	4.8	26.4	90 x (1±10%)
48	40.6	9.6	52.8	300 x (1±10%)
120	102	24	132	2000 x (1±10%)
240	204	48	264	7200 x (1±10%)
277	235	55.4	304.7	11000 x (1±10%)

Notes: *Maximum voltage refers to the maximum voltage which relay coil could endure in a short period of time.

SAFETY APPROVAL RATINGS

UL/CUL (AC type)	Rating
HF84F-1	8FLA, 25LRA 250VAC at 40°C 16A 250VAC Resistive at 65°C 8A 250VAC General use at 40°C
HF84F-4	8FLA, 25LRA 250VAC at 40°C 16A 250VAC Resistive at 65°C 8A 250VAC General use at 40°C
HF84F-7	8FLA, 25LRA 250VAC at 40°C 8A 250VAC General use at 40°C

Notes: 1) All values unspecified are at room temperature.
2) Only typical loads are listed above. Other load specifications can be available upon request.



HONGFA RELAY

ISO9001, ISO/TS16949, ISO14001, OHSAS18001, IECQ QC 080000 CERTIFIED

ORDERING INFORMATION

Type	HF84F	-1	A	24	(XXX)
Contact arrangement	1: 1 Form C 4: 1 Form A 7: 1 Form B				
Coil voltage form	D: DC A: AC				
Coil voltage	AC: 6VAC to 277VAC DC: 6VDC to 120VDC (No UL approved)				
Special code ¹⁾	XXX: Customer special requirement		Nil: Standard		

Notes: 1) The customer special requirement express as special code after evaluating by Hongfa.

OUTLINE DIMENSIONS, WIRING DIAGRAM AND PC BOARD LAYOUT

Unit: mm

Outline Dimensions

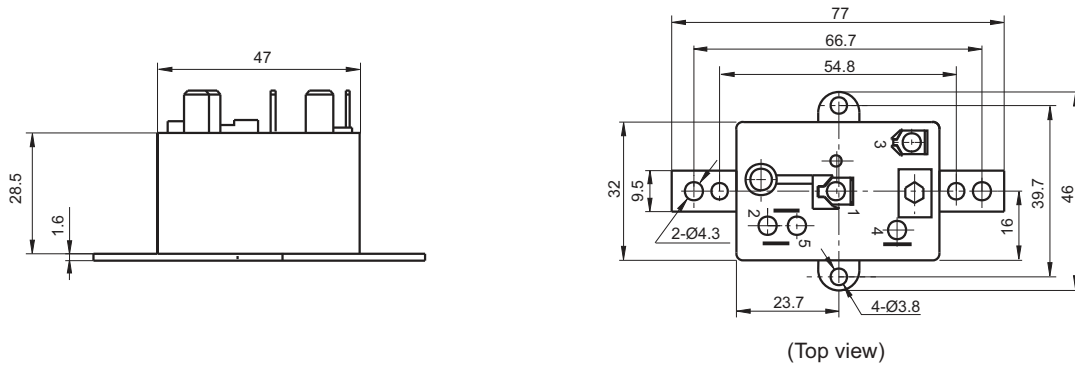

Wiring Diagram (Top view)

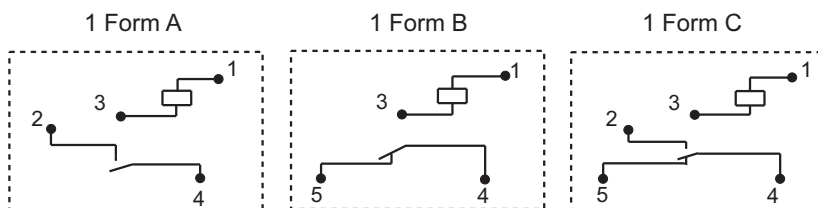

Terminals type

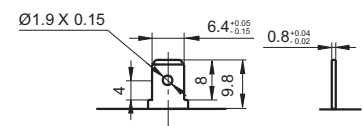

Remark: In case of no tolerance shown in outline dimension: outline dimension ≤ 1 mm, tolerance should be ± 0.2 mm; outline dimension > 1 mm and ≤ 5 mm, tolerance should be ± 0.3 mm; outline dimension > 5 mm, tolerance should be ± 0.4 mm.

Disclaimer

The specification is for reference only. See to "Terminology and Guidelines" for more information. Specifications subject to change without notice. We could not evaluate all the performance and all the parameters for every possible application. Thus the user should be in a right position to choose the suitable product for their own application. If there is any query, please contact Hongfa for the technical service. However, it is the user's responsibility to determine which product should be used only.

© Xiamen Hongfa Electroacoustic Co., Ltd. All rights of Hongfa are reserved.

HF94F

HIGH POWER RELAY



File No.:E134517 (AC type)



Features

- 25A switching capability
- 2kV dielectric strength (between coil and contacts)
- Panel mount, various terminal types
- UL insulation system: Class F
- Environmental friendly product (RoHS compliant)
- Outline Dimensions: (47.0 x 32.0 x 28.5) mm

CONTACT DATA

Contact arrangement	1A, 1B, 1C, 1A + 1B
Contact resistance	200mΩ max.(at 1A 24VDC)
Contact material	AgCe, AgCdO
Contact rating (Res.load)	18A 277VAC
Max. switching voltage	277VAC
Max. switching current	18A
Max. switching power	4986VA
Mechanical endurance	1 x 10 ⁶ OPS
Electrical endurance	5 x 10 ⁴ OPS (25A 277VAC, Resistive load, AgCdO, at 65°C, 1s on 9s off) 3 x 10 ⁴ OPS (3A 277VAC, General load, AgCe, at 65°C, 1s on 9s off)

CHARACTERISTICS

Insulation resistance	500MΩ (at 500VDC)	
Dielectric strength	Between coil & contacts	2000VAC 1min
	Between open contacts	1000VAC 1min
Operate time (at nomi. volt.)	DC type: 25ms max.	
Release time (at nomi. volt.)	DC type: 25ms max.	
Temperature rise (at nomi. volt.)	90K max.	
Shock resistance (Functional)	98m/s ²	
Vibration resistance	10Hz to 55Hz 0.5mm DA	
Ambient temperature	-40°C to 65°C	
Humidity	5% to 85% RH	
Termination	QC	
Unit weight	Approx. 85g	
Construction	Dust protected	

Notes: 1) The data shown above are initial values.

COIL

Coil power	DC type: Approx. 2.4W; AC type: Approx. 4.0VA
------------	--

COIL DATA

Nominal Voltage VDC	Pick-up Voltage VDC max.	Drop-out Voltage VDC min.	Max. Voltage VDC *	Coil Resistance Ω
6	4.50	0.6	6.6	17.5 x (1±10%)
9	6.75	0.9	9.9	40 x (1±10%)
12	9.00	1.2	13.2	70 x (1±10%)
24	18.0	2.4	26.4	280 x (1±10%)
48	36.0	4.8	52.8	1120 x (1±10%)
120	90.0	12.0	132	7000 x (1±10%)

Nominal Voltage VAC	Pick-up Voltage VAC max.	Drop-out Voltage VAC min.	Max. Voltage VAC *	Coil Resistance Ω
6	5.1	1.2	6.6	4.8 x (1±10%)
12	10.2	2.4	13.2	19 x (1±10%)
24	20.4	4.8	26.4	77 x (1±10%)
48	40.8	9.6	52.8	280 x (1±10%)
120	102	24	132	2000 x (1±10%)
240	204	48	264	7250 x (1±10%)
277	235	55.4	304.7	11000 x (1±10%)

Notes: *Maximum voltage refers to the maximum voltage which relay coil could endure in a short period of time.



HONGFA RELAY

ISO9001, ISO/TS16949, ISO14001, OHSAS18001, IECQ QC 080000 CERTIFIED

SAFETY APPROVAL RATINGS

UL/CUL	HF94F-10	NO	AgCdO	12FLA,60LRA,120VAC at 65°C 8FLA,48LRA,250VAC at 65°C 8FLA,48LRA,277VAC at 65°C 7FLA,42LRA,277VAC at 65°C 25A,277VAC,Resistive at 65°C
			AgCe	3A,277VAC,Gen Use at 65°C 277VAC pilot duty,10A inrush,1A break at 65°C
	HF94F-11	NC	AgCdO	14FLA,84LRA,125VAC at 40°C 8FLA,48LRA,250VAC at 65°C 8FLA,48LRA,277VAC at 65°C 7FLA,42LRA,277VAC at 65°C 25A,277VAC,Resistive at 65°C
			AgCe	3A,277VAC,Gen Use at 65°C 277VAC pilot duty,10A inrush,1A break at 65°C
	HF94F-12	NO/NC	AgCdO	14FLA,84LRA,125VAC at 40°C 8FLA,48LRA,250VAC at 65°C 8FLA,48LRA,277VAC at 65°C 7FLA,42LRA,277VAC at 65°C 25A,277VAC,Resistive at 65°C
			AgCe	3A,277VAC,Gen Use at 65°C 277VAC pilot duty,10A inrush,1A break at 65°C
	HF94F-13	NO/NC	AgCdO	12FLA,60LRA,120VAC at 65°C 8FLA,48LRA,250VAC at 65°C 8FLA,48LRA,277VAC at 65°C 7FLA,42LRA,277VAC at 65°C 18A,277VAC,Resistive at 65°C 25A,277VAC,Resistive at 65°C
			AgCe	3A,277VAC,Gen Use at 65°C 277VAC pilot duty,10A inrush,1A break at 65°C

Notes: 1) All values unspecified are at room temperature.

2) Only typical loads are listed above. Other load specifications can be available upon request.

ORDERING INFORMATION

Type	HF94F	-10	A	24	E	-1	(XXX)
Contact arrangement	10: 1 Form A 11: 1 Form B 12: 1 Form C 13: 1 Form A+1 Form B						
Coil voltage form	A: AC D: DC						
Coil voltage	AC: 6VAC to 277VAC DC: 6VDC to 120 VDC (No UL approved)						
Contact material	E: AgCe Nil: AgCdO						
Mounting	1: Flang, Mounting Distance 54.8mm. diameter Ø3.8mm 2: Flang, Mounting Distance 66.7mm. diameter Ø4.8mm Nil: Metal Bracket						
Special code ¹⁾	XXX: Customer special requirement Nil: Standard						

Notes: 1) The customer special requirement express as special code after evaluating by Hongfa.

OUTLINE DIMENSIONS, WIRING DIAGRAM AND PC BOARD LAYOUT

Unit: mm

Outline Dimensions

Metal Bracket

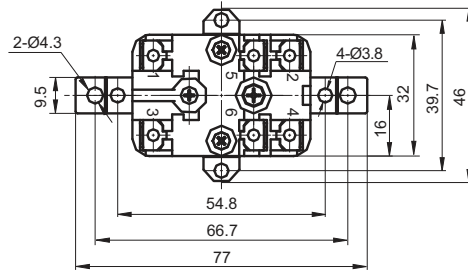
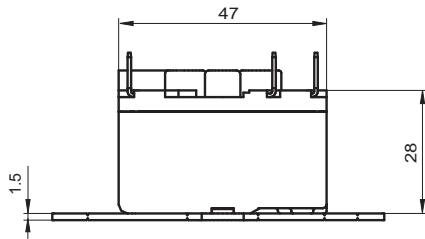

(Top view)

Flang, Mounting Distance 54.8mm

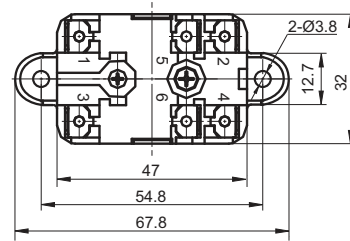
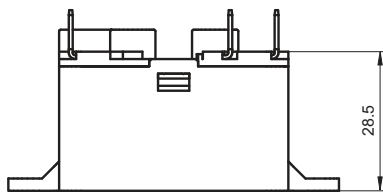

(Top view)

Flang, Mounting Distance 66.7mm

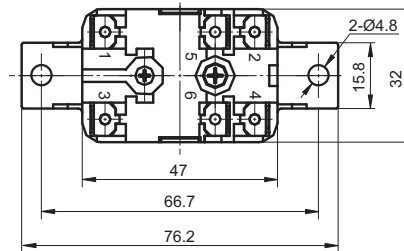
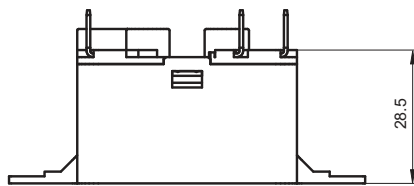

(Top view)

Terminals type

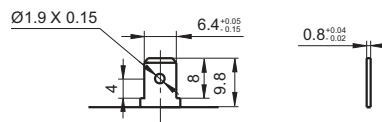

Remark: In case of no tolerance shown in outline dimension: outline dimension $\leq 1\text{mm}$, tolerance should be $\pm 0.2\text{mm}$; outline dimension $> 1\text{mm}$ and $\leq 5\text{mm}$, tolerance should be $\pm 0.3\text{mm}$; outline dimension $> 5\text{mm}$, tolerance should be $\pm 0.4\text{mm}$.

Wiring Diagram

(Top view)

1 Form A

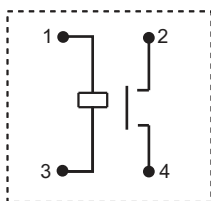

1 Form B

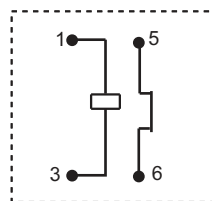

1 Form C

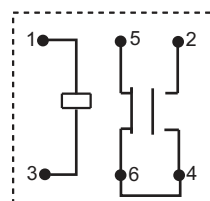

1A+1B

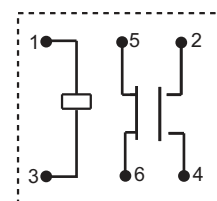

Disclaimer

The specification is for reference only. See to "Terminology and Guidelines" for more information. Specifications subject to change without notice. We could not evaluate all the performance and all the parameters for every possible application. Thus the user should be in a right position to choose the suitable product for their own application. If there is any query, please contact Hongfa for the technical service. However, it is the user's responsibility to determine which product should be used only.

© Xiamen Hongfa Electroacoustic Co., Ltd. All rights of Hongfa are reserved.

HF8565

MOTOR START POTENTIAL RELAY



File No.:SA13318



Features

- 50A switching capability
- 1 Form B configuration available
- 250" quick connect termination
- UL insulation system: Class F
- Various of mounting positions
- Environmental friendly product (RoHS compliant)
- Outline Dimensions: (51.2 x 46.6 x 36.5) mm

CONTACT DATA

Contact arrangement	1B
Contact resistance	100mΩ max.(at 1A 24VDC)
Contact material	Silver alloy
Contact rating (Res. load)	16A(make and break) 400VAC COS Ø=0.85 35A(break only) 400VAC COS Ø=0.85 50A(break only) 400VAC COS Ø=0.85
Mechanical endurance	7.5 x 10 ⁵ OPS
Electrical endurance	SPST-NC: 5 x 10 ⁵ OPS (16A on and off 400VAC cosØ=0.7-0.8 at 25°C 1s on 9s off) SPST-NC: 2 x 10 ⁵ OPS (35A only off 400VAC cosØ=0.7-0.8 at 25°C 1s on 9s off) SPST-NC: 1 x 10 ⁵ OPS (50A only off 400VAC cosØ=0.7-0.8 at 25°C 1s on 9s off)

CHARACTERISTICS

Weight	Approx. 110g
Termination	QC
Construction	Dust protected

Notes: The data shown above are initial values.

COIL

Coil power	Approx. 5VA
Coil voltage	See table below
Coil resistance	See table below
Insulation system	Class B

OPERATING CHARACTERISTICS at 50Hz

Coil number	2		3		4		5		6		7		8		9		
Vmax at 40°C (V)	299		338		378		356		452		151		530		228		
Resistance (1±10%) Ω at 25°C	5600		7500		10700		10000		13800		1500		19500		3900		
	H.P.U.	P.U.	D.O.	P.U.	D.O.	P.U.	D.O.	P.U.	D.O.	P.U.	D.O.	P.U.	D.O.	P.U.	D.O.	P.U.	D.O.
A	120-130											111-124	20-45			111-124	35-77
B	130-140											120-134	20-45			120-134	35-77
C	150-160	140-153	40-90									130-144	20-45			130-144	35-77
D	160-170	150-163	40-90	150-163	40-90							140-153	20-45			140-153	35-77
E	170-180	162-175	40-90	162-175	40-90											149-163	35-77
F	180-190	171-184	40-90	171-184	40-90			180-195	40-105							157-172	35-77
G	190-200	180-193	40-90	180-195	40-105	180-195	40-105	189-205	40-105							168-182	35-77
H	200-220	186-215	40-90	190-215	40-105	195-224	50-110	186-214	60-133							178-192	35-77
I	220-240	205-234	40-105	208-239	50-110	204-233	50-110	204-233	60-133							183-213	35-77
L	240-260	224-252	40-105	224-252	50-110	223-259	50-110	223-252	60-133	223-252	60-130					203-231	35-77
M	260-280	243-271	40-105	239-270	50-110	242-272	50-110	242-272	60-133	239-268	60-135			239-268	75-170		
N	280-300			260-289	50-110	262-290	60-121	262-290	60-133	258-287	60-135			258-287	75-170		
O	300-320					280-310	60-121	280-310	60-133	277-305	60-135			277-305	75-170		
P	320-340					300-328	60-121	300-328	60-154	295-324	60-135			295-324	75-170		
Q	340-360					318-347	60-121			314-342	60-135			314-342	75-180		
R	350-370													323-352	75-180		
S	360-380													332-361	75-180		

Notes: H.P.U.means Approximate pick-up value at 90°C , P.U. means pick-up value at 25°C, D.O.means drop out value at 25°C.



HONGFA RELAY

ISO9001, ISO/TS16949, ISO14001, OHSAS18001, IECQ QC 080000 CERTIFIED

OPERATING CHARACTERISTICS at 60Hz

Coil number	2		3		4		5		6		7		8		9		
V _{max} at 40°C (V)	332		375		420		395		502		168		588		253		
Resistance (1 ± 10%) Ω at 25°C	5600		7500		10700		10000		13800		1500		19500		3900		
	H.P.U.	P.U.	D.O.	P.U.	D.O.	P.U.	D.O.	P.U.	D.O.	P.U.	D.O.	P.U.	D.O.	P.U.	D.O.	P.U.	D.O.
AA	120-130											111-124	20-45			111-124	35-77
AB	130-140											120-134	20-45			120-134	35-77
AC	150-160											130-144	20-45			130-144	35-77
AD	160-170	150-163	40-90									140-153	20-45			140-153	35-77
AE	170-180	162-175	40-90									149-163	20-45			149-163	35-77
AF	180-190	171-184	40-90					180-195	40-105							157-172	35-77
AG	190-200	180-193	40-90	180-195	40-105			189-205	40-105							168-182	35-77
AH	200-220	186-215	40-90	190-215	40-105	195-224	60-121	186-214	60-130							178-192	35-77
AI	220-240	205-234	40-90	208-239	50-110	204-233	60-121	204-233	60-130							183-213	35-77
AL	240-260	224-252	40-105	224-252	50-110	223-259	60-121	223-252	60-130							203-231	35-77
AM	260-280	243-271	40-105	239-270	50-110	242-272	60-121	242-272	60-140	239-268	60-135					221-250	35-77
AN	280-300			260-289	50-110	262-290	60-121	262-290	60-140	258-287	60-135		258-287	75-170			
AO	300-320					280-310	60-121	280-310	60-140	277-305	60-135		277-305	75-170			
AP	320-340					300-328	60-121	300-328	60-140	295-324	60-135		295-324	75-170			
AQ	340-360					318-347	60-121			314-342	60-135		314-342	75-180			
AR	350-370												323-352	75-180			
AS	360-380												332-361	75-180			

Notes: H.P.U.means Approximate pick-up value at 90°C , P.U. means pick-up value at 25°C, D.O.means drop out value at 25°C.

OPERATING POSITION

	1	2	3	4	5	6
PLASTIC TAB MOUNT						
PANEL MOUNT						
METAL TAB MOUNT						

TERMINAL CONFIGURATION

		3 dual QC (#1, 2, 5)
PLASTIC TAB MOUNT		D
PANEL MOUNT		P
METAL TAB MOUNT		Z

ORDERING INFORMATION

Type	HF8565 /	D	6	A	1 (XXX)
Terminal configuration	D、P、Z (See table for terminal configuration)				
Coil number	2、3、4、5、6、7、8、9				
Operation characteristics	AA to AS (See table for operating characteristics)				
Operation position	1、2、3、4、5、6				
Special code ¹⁾	XXX: Customer special requirement	Nil: Standard			

Notes: 1) The customer special requirement express as special code after evaluating by Hongfa.

OUTLINE DIMENSIONS, WIRING DIAGRAM AND PC BOARD LAYOUT

Unit: mm

Plastic Tab Mount

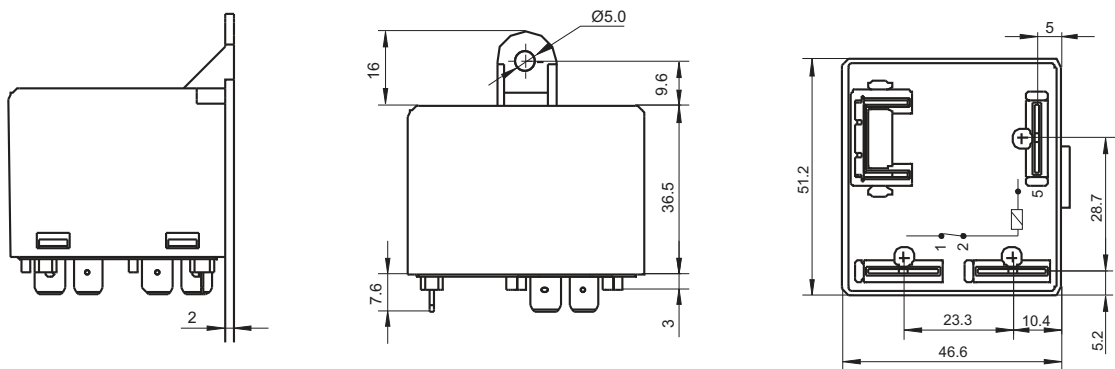

Panel Mount

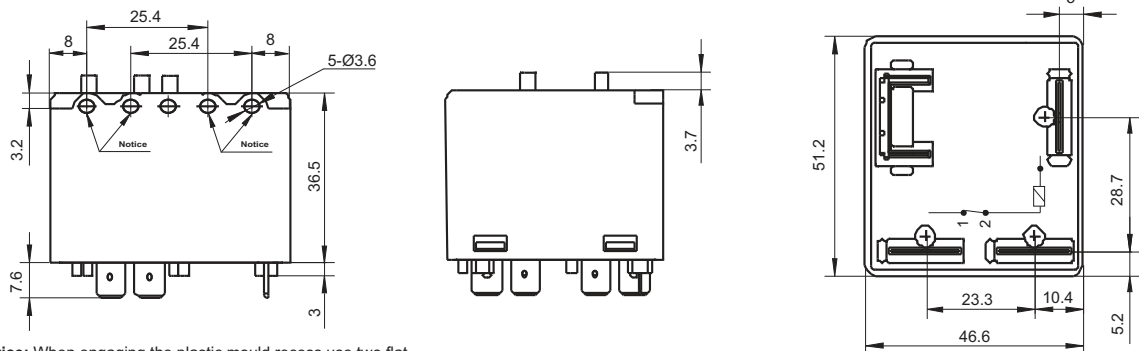

Notice: When engaging the plastic mould recess, use two flat head, self tapping screw, size 4.2mm, 9.5mm long.

Metal Tab Mount

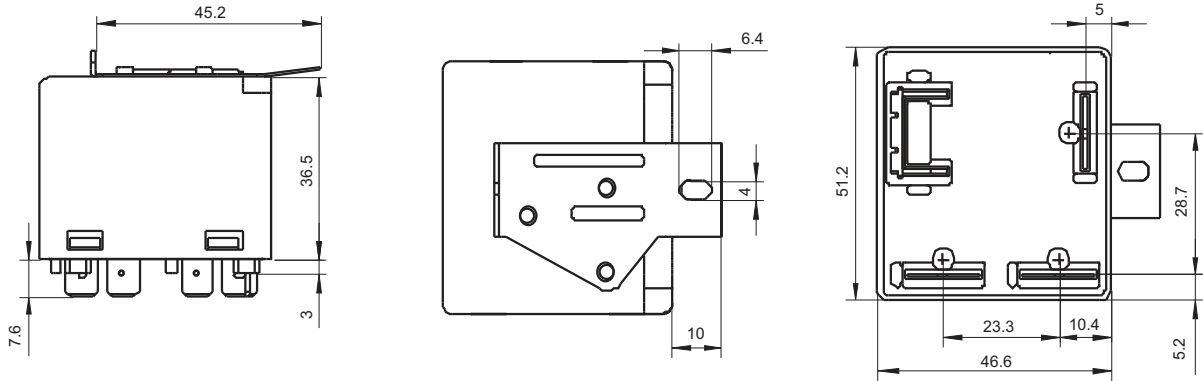

Remark: In case of no tolerance shown in outline dimension: outline dimension ≤ 1 mm, tolerance should be ± 0.2 mm; outline dimension > 1 mm and ≤ 5 mm, tolerance should be ± 0.3 mm; outline dimension > 5 mm, tolerance should be ± 0.4 mm.

Wiring Diagram

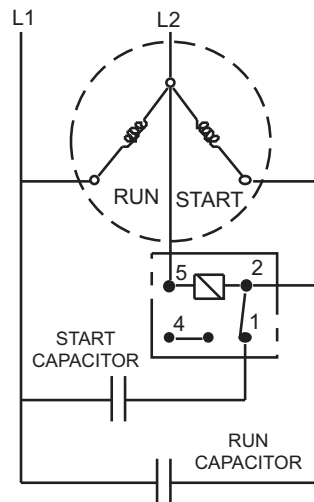

Disclaimer

The specification is for reference only. See to "Terminology and Guidelines" for more information. Specifications subject to change without notice. We could not evaluate all the performance and all the parameters for every possible application. Thus the user should be in a right position to choose the suitable product for their own application. If there is any query, please contact Hongfa for the technical service. However, it is the user's responsibility to determine which product should be used only.

COMPARATIVE LIST BETWEEN THE OLD AND NEW ORDERING TYPE

New Ordering Type	Old Ordering Type	New Ordering Type	Old Ordering Type
Signal Relay		HF36FD	---
HFD2	---	HF37F	JQX-37F
HFD3	---	HF41F	---
HFD3-V	---	HF42F	JZC-42F
HFD4	---	HF46F	---
HFD23	JRC-23F	HF46F-G	---
HFD27	JRC-27F	HF49FD	---
HFD31	---	HF62F	JQX-62F
HFD41/41A	HM4100F/HM4101F	HF84F	8400
HFD42	---	HF92F	692
Power Relay		HF94F	9400
HF3F-L	---	HF102F	JQX-102F
HF3FA	---	HF105F-1	JQX-105F-1
HF3FD	---	HF105F-2	JQX-105F-2
HF3FF-M	---	HF105F-4	JQX-105F-4
HF3FF	JQC-3FF	HF105F-5	JQX-105F-5
HF7FD	JQC-7FD	HF115F	JQX-115F
HF7FF	JZC-7FF	HF115F-A	---
HF8	---	HF115F-H	JQX-115F-H
HF12FF	JQC-12FF	HF115F-I	JQX-115F-I
HF14FF	JQX-14FF	HF115F-L	---
HF14FW	JQX-14FW	HF115F-LS	---
HF21FF	JQC-21FF	HF115F-Q	JQX-115F-Q
HF25F	JQC-25F	HF115F-S	---
HF32F	JZC-32F	HF115F-T/TH	JQX-115F-T/TH
HF32F-G	---	HF115FP	---
HF32FA	JZC-32FA	HF115FK	---
HF32FA-T	JZC-32FA-T	HF115FK-T	---
HF32FA-G	---	HF158F	---
HF32FV	---	HF158F-V	---
HF32FV-G	---	HF116F-1	JQX-116F-1
HF33F	JZC-33F	HF116F-2	JQX-116F-2
HF36F	JZC-36F	HF116F-3	JQX-116F-3

COMPARATIVE LIST BETWEEN THE OLD AND NEW ORDERING TYPE

New Ordering Type	Old Ordering Type
HF116F-80	---
HF116F-G	---
HF118F	JQX-118F
HF140FF	JZX-140FF
HF141FF	JQX-141FF
HF152F	---
HF152FD	---
HF160F	---
HF161F	---
HF161F-W	---
HF162F	---
HF163F-L	---
HF165F	---
HF165FD	---
HF165FD-G	---
HF166F	---
HF2100	---
HF2110/HF2120	---
HF2150	---
HF2160	---
HF7520	---
HF8565	---
HFE7	JE7

Notes: Now we have finished switching to be the head of "HF" as new ordering type, we strongly recommend that you should use the new ordering type for your orders.



HONGFA RELAY

ISO9001, ISO/TS16949, ISO14001, OHSAS18001, IECQ QC 080000 CERTIFIED

CROSS REFERENCE GUIDE

Power Relay

HONGFA	OMRON	PANASONIC	TE			NEC
			OEG	P&B	SCHRACK	
HF3FA	G5LA	JS			T7S	
HF3FD	G5LB	JS			T7S	
HF3FF	G5LC/G5LE	JS	PCE/ORWH	T72	T7N	
HF3FF-M	G8SN	JSM			T72N	
HF7FD	G5LE-VD	JSM	PCE	T7N	T7N-WG	KB
HF7FF	G5LC/G5LE	JSM	PCE	T7N	T7N	
HF8			OU DH	T73	41891/UB	
HF14FF	G2R	JR1/JR1A	OMI	RKA/RKS	409/cardE/RPII1	CH
HF14FW	G2R	JR1AF	OMI-H/OZ	RKA/RKS		
HF21FF	G5L		SRUDH/SRUUH	T7C	LN/41896	
HF25F	G5G	LE				
HF32FV			OJ/OJE	T77		
HF32FV-G			OJ/OJE	T77		CS
HF32F			OJ/OJE	T77		
HF32F-G			OJ/OJE	T77		
HF32FA/HF32FA-T	G5SB/G5Q	JQ/PQ	OJ/OJE	T77	RE/REL	
HF32FA-G	G5PA-1	LK	OJ/OJE	T77		
HF33F			PCH	T77		
HF36F/HF36FD		PE/PF	SDT		V23092(SNR)	CK
HF37F	G5PA-2	LA				CW
HF41F	G5NB/G5T	LD				
HF42F	G6DS	PA	OSA/PCI	T74	PCN	CU
HF46F/HF46F-G	G5J	JR1AF-TMP				
HF49FD					T92	
HF62F	G4A	LF	OMIF			
HF92F	G8P	JTN/JTV		T92	T9A	
HF102F	G7G/G8P	JT	PCFN			CT
HF105F-1	G7G/G8P	JT	ORU	T9A/T90		
HF105F-2			ORU	491/T9A		

This table is just for reference. if you have any questions, please contact our local agent or send e-mail to marketing@hongfa.com.



HONGFA RELAY
ISO9001, ISO/TS16949, ISO14001, OHSAS18001, IECQ QC 080000 CERTIFIED

CROSS REFERENCE GUIDE

(To be continued)

Power Relay

HONGFA	FUJITSU	FEME	FINDER	SONGCHUAN
HF3FA				899
HF3FD				899
HF3FF		VTA/H	36.11	833H
HF3FF-M				
HF7FD	FBR160			812BH
HF7FF	CS			812
HF8	LZ	EM-EMH		843
HF14FF	VS	MZPA-001	40.31	845-1P
HF14FW	FBR610	MZPA-001	40.61	793P
HF21FF				801H
HF25F				
HF32FV	JV			
HF32FV-G	JV			
HF32F	JV			835/835NL
HF32F-G	JV			835/835NL
HF32FA/32FA-T	JV			835/835NL
HF32FA-G	JV	JF		835/835NL
HF33F	JY	MXH		892
HF36F/HF36FD	FTR-H2/F2			
HF37F	VF		34.51	
HF41F	FTR-LY			882
HF42F	FTR-F4			401
HF46F/HF46F-G	FTR-F3			202/202H
HF49FD	RB/NY			
HF62F	VR	CS/CF30		302
HF92F				
HF102F				
HF105F-1				832
HF105F-2				832

This table is just for reference.if you have any questions,please contact our local agent or send e-mail to marketing@hongfa.com.



HONGFA RELAY

ISO9001, ISO/TS16949, ISO14001, OHSAS18001, IECQ QC 080000 CERTIFIED

CROSS REFERENCE GUIDE

Power Relay

HONGFA	OMRON	PANASONIC	TE			NEC
			OEG	P&B	SCHRACK	
HF105F-4			ORU	T9A		
HF105F-5	G7G/G8P	JTN	ORU	T90/T9A		
HF115F	G2RL	JW1/JW2/DJ		RT	RT/42900/RT1/RT2	TH
HF115-A	G5RL-AC				RT1/RT2/RX1/RX2	
HF115F-H				RT	RT1 sensitive	
HF115F-I				RT	42903/42903A	
HF115F-S					RTS3T	
HF115F-L		DJ			RT1 bistable	
HF115F-LS					RTX/RTS3T	
HF115F-Q					RF/41063 125°C	
HF115F-T/TH				RT	RTH105 16A	
HF115FP					XT	
HF115FK	G2RL	JWI/JWZ/DJ			RZ	
HF115FK-T				RT	RTH105 16A	
HF158F	G2RL	LZ				
HF116F-1	G7L	HE				
HF116F-2	G7L	HE				
HF116F-3	G7L	HE				
HF116F-G		HE				
HF116F-80		HE				
HF118F	G6RN				RYII	
HF140FF	G2R/G2RG	JR2/JR2A	OMI	RKA/RKS	409/RPII2/SR2M	TP
HF141FF	G2R	JW	OMI			TP
HF152F/HF152FD	G5LE-VD	JSM				
HF160F	G4F	JM	PCF		PCJ	CU
HF161F	G4A	LF	PCFN			
HF161F-W		LF-G	PCFNSOLAR			
HF162F	G5PF	LK-F				
HF163F-L		DW				
HF165FD	G8P	JTN/JTV	ORU	T90/T9A		
HF165FD-G						

This table is just for reference. if you have any questions, please contact our local agent or send e-mail to marketing@hongfa.com.



HONGFA RELAY

ISO9001, ISO/TS16949, ISO14001, OHSAS18001, IECQ QC 080000 CERTIFIED

CROSS REFERENCE GUIDE

(To be continued)

Power Relay

HONGFA	FUJITSU	FEME	FINDER	SONGCHUAN
HF105F-4				832
HF105F-5				832
HF115F	FTR-K1	M25	41series	881/888
HF115-A				881
HF115F-H	FTR-K1			881/845N
HF115F-S				
HF115F-I	FTR-H1			881/888
HF115F-L	FTR-K1L			
HF115F-LS				
HF115F-Q				881WP
HF115F-T/TH	FTR-K1			881
HF115FP				
HF115FK	FTR-K1			
HF115FK-T	FTR-K1			881
HF158F	FTR-K1		41 series	
HF116F-1				841
HF116F-2				841
HF116F-3				841
HF116F-G				510H
HF116F-80				511E
HF118F	FTR-F1	M15E		
HF140FF	FTR-F1/VSB	MZPA-002	40.52	845-2P
HF141FF	FTR-F1/VSB		40.31	845-H
HF152F				875
HF160F	VH/FTR-K3			821
HF161F				
HF161F-W				
HF162F				
HF163F-L				
HF165FD				
HF165FD-G				832HA

This table is just for reference. if you have any questions, please contact our local agent or send e-mail to marketing@hongfa.com.



HONGFA RELAY

ISO9001, ISO/TS16949, ISO14001, OHSAS18001, IECQ QC 080000 CERTIFIED

CROSS REFERENCE GUIDE

(To be continued)

Power Relay

HONGFA	OMRON	PANASONIC	TE			NEC
			OEG	P&B	SCHRACK	
HF165F			T9S SOLAR			
HF2100	G7G	JT		491/T9A		
HF2110/HF2120	G7G	JT	491/T90		T9A	CT
HF2150/HF2151	G7G	JTN/JTV	T9A/T90			CT
HF2160		JT	T9A/T90			CT
HF7520	G5CA	JV/JVN		PCD		CQ
HFE7	G6C	DK				

(To be continued)

HONGFA	FUJITSU	FEME	FINDER	SONGCHUAN
HF165F				
HF2100		CGQ		832
HF2110/HF2120		CGQ		832A
HF2150/HF2151				832
HF2160				852
HF7520				201
HFE7				

This table is just for reference. if you have any questions, please contact our local agent or send e-mail to marketing@hongfa.com.



HONGFA RELAY

ISO9001, ISO/TS16949, ISO14001, OHSAS18001, IECQ QC 080000 CERTIFIED

CROSS REFERENCE GUIDE

Signal Relay

HONGFA	OMRON	PANASONIC	TE				NEC
			TYCO	AXICOM	OEG	P&B	
HFD23	G5V-1	HY	V23111		TSC		TY
HFD27	G5V-2	DS2Y		D2N (V23105)	OVR/ORZ	T82/T85/190	MR62
HFD2	G6A	DS2Y	V23042	MT2			MR82
HFD3	G6S	TX		P2 (V23079)			EC2/ED2
HFD3-V				FT			
HFD31	G6H	TQ		FP2			EA2
HFD4	G6K	AGQ		IM			
HFD41	G2E			V23101	OUA/OUAZ	T81	
HFD41A	G2E			V23101	OUA/OUAZ	T81	
HFD42	G6J	AGN		IM			

(To be continued)

HONGFA	FUJITSU	FEME	FINDER	SONGCHUAN
HFD23	SY	EZ-EZH		
HFD27	FBR244/ FTR-C2/RV	ZFH-002	30.22	876
HFD2	RA	TF/TFL2		502
HFD3	BA/NA			902
HFD3-V	FTR-C1			
HFD31	A			
HFD4				
HFD41	FBR211SC/MZ			842
HFD41A	FBR211SE/MZ	ESH-001		842A
HFD42	FTR-B4			UA2/UB2

This table is just for reference.if you have any questions,please contact our local agent or send e-mail to marketing@hongfa.com.



HONGFA RELAY

ISO9001, ISO/TS16949, ISO14001, OHSAS18001, IECQ QC 080000 CERTIFIED

PACKING LIST

Type	Packing Method	Carton Size L x W x H cm	QTY/CTN PCS	Approx. N.W. kg	Approx. G.W. kg	Stacking Layers Limit n
HF3F-L	100pcs/box	34 x 22 x 14.5	1000	10	12	7
HF3FA	100pcs/box	34 x 22 x 14.5	1000	8	10	8
HF3FD	100pcs/box	36 x 24 x 16	1000	10	12	7
HF3FF	100pcs/box	35.5 x 23.5 x 16	1000	10	12	7
HF7FD(double pin)	32pcs/tube	63 x 15 x 16	800	7.4	11.2	7
HF7FD	20pcs/tube	40 x 31 x 22	1000	9.3	13.1	6
HF7FD	100pcs/box	46 x 31 x 19	1000	9.3	11.1	7
HF7FF	20pcs/tube	40 x 30 x 22	1000	10	11.5	6
HF8	20pcs/tube	40 x 31 x 22	1000	9.3	13.1	6
HF8A	20pcs/tube	40 x 31 x 22	1000	9.4	13.2	6
HF14FF	50pcs/tray	35 x 29 x 22	500	8.7	10.5	6
HF14FW	50pcs/tray	35 x 29 x 22	500	8.7	10.5	6
HF21FF	30pcs/tube	56 x 29 x 20	1500	19.4	23.2	4
HF25F	50pcs/tray	35 x 29 x 17	500	7.4	9.1	6
HF32F	100pcs/box	32 x 26 x 19	1000	6	7.5	7
HF32FV/HF32FV-G	100pcs/box	32 x 26 x 19	1000	6	7.5	7
HF32F/HF32F -G	100pcs/box	32 x 26 x 19	1000	6	7.5	7
HF32FA	100pcs/box	33.5 x 27.5 x 20.5	1000	6	7.5	7
HF32FA-T	100pcs/box	34 x 28 x 21	1000	6	7.5	7
HF32FA-G	100pcs/box	34 x 28 x 21	1000	6	7.5	7
HF33F	100pcs/box	32 x 26 x 19	1000	6	7.5	7
HF36F	20pcs/tube	56 x 39 x 18	1000	12	14.5	6
HF36FD	50pcs/box	38 x 30 x 27	1000	9.6	11.4	5
HF37F	25pcs/tray	35 x 29 x 24	100	5.5	7	6
HF41F	100pcs/tube	59.5 x 18.5 x 14.5	2000	10.8	14.1	6
HF42F	50pcs/box	39 x 34 x 25	1000	14.5	16.3	5
HF46F	150pcs/box	33.5 x 27.5 x 20.5	1500	6	7.5	7
HF46F-G	150pcs/box	33.5 x 27.5 x 20.5	1500	6	7.5	7
HF49FD	100pcs/tube	59.5 x 18 x 18.5	3000	9	12	7
HF62F	50pcs/tray	35 x 29 x 22	500	7.5	9.3	6
HF62F(1HT)	50pcs/tray	35 x 29 x 22	500	7.5	9.3	6
HF84F/HF94F	1pcs/box	36 x 36 x 22	100	8.5	10	6

Notes: This above list is the typical packing specification. Specifications and dimensions in this catalog are subject to change without notice.

Type	Packing Method	Carton Size L x W x H cm	QTY/CTN PCS	Approx. N.W. kg	Approx. G.W. kg	Stacking Layers Limit n
HF84F/HF94F	25pcs/tray	36 x 36 x 22	100	8.5	10	6
HF92F	20pcs/tray	35 x 29 x 24	100	8.6	10.1	6
HF102F	50pcs/box	40 x 27 x 18	400	9.2	10.7	8
HF105-1/-1L (Unenclosed)	50pcs/tray	35 x 29 x 22	350	8.5	10	6
HF105F-1/-1L	40pcs/tray	40 x 27 x 22	400	8.5	10	6
HF105F-2/-2L	40pcs/tray	35 x 29 x 24	240	7.5	9	6
HF105F-4	40pcs/tray	35 x 29 x 24	240	8.5	10	6
HF105F-4L	40pcs/tray	35 x 29 x 24	240	8.5	10	6
HF105F-5/-5L	40pcs/tray	35 x 29 x 24	240	7.5	9	6
HF115F	20pcs/tube	65 x 18 x 14	1000	13.5	15.5	5
HF115F/-H/-I/-T/-TH/-L/-LS	50pcs/tray	40 x 27 x 22	500	6.8	8.3	7
HF115F-A/-H/-I/-T/-TH/-L/-LS	20pcs/tube	65 x 18 x 14	1000	13.5	15.5	5
HF115F-Q	40pcs/tray	35 x 29 x 24	400	6.5	8	6
HF115FP	50pcs/tray	35 x 29 x 24	500	9	10.5	6
HF115FD	20pcs/tube	65 x 18 x 14	1000	13.5	15.5	5
HF115FD	50pcs/tray	40 x 27 x 22	500	6.8	8.3	7
HF115FK	20pcs/tube	65 x 18 x 14	1000	13.5	15.5	5
HF115FK	50pcs/tray	40 x 27 x 22	500	6.8	8.3	7
HF115FK-T	20pcs/tube	65 x 18 x 14	1000	13.5	15.5	5
HF115FK-T	50pcs/tray	40 x 27 x 20	500	6.8	8.3	7
HF116F-1	16pcs/tray	35 x 29 x 24	80	9.6	11.1	6
HF116F-2	16pcs/tray	35 x 29 x 24	80	9.6	11.1	6
HF116F-3 (A type)	5pcs/box	32 x 17 x 19	50	6	7.5	7
HF116F-3 (F type)	5pcs/box	33 x 19 x 19	50	6	7.5	7
HF116F-80	16pcs/tube	35 x 29 x 24	80	9.6	11.1	6
HF116F-G	16pcs/tube	35 x 29 x 24	80	9.6	11.1	6
HF118F	20pcs/tray	64 x 17 x 15	1000	8.2	10.2	8
HF140FF	50pcs/tray	35 x 29 x 22	500	8.8	10.6	6
HF141FF	50pcs/tray	35 x 29 x 22	500	6.7	8.5	6
HF152F	50pcs/box	45 x 30 x 22	1000	12.2	14	6
HF152F	25pcs/tube	50 x 22 x 19	1000	12.2	16	5
HF158F	20pcs/tube	65 x 18 x 14	1000	13.5	15.5	5

Notes: This above list is the typical packing specification. Specifications and dimensions in this catalog are subject to change without notice.

Type	Packing Method	Carton Size L x W x H cm	QTY/CTN PCS	Approx. N.W. kg	Approx. G.W. kg	Stacking Layers Limit n
HF158F	50pcs/bray	40 x 27 x 22	500	6.8	8.3	7
HF158F-V	20pcs/tube	65 x 18 x 14	800	17	13.3	5
HF160F	50pcs/box	40 x 27 x 22	400	10.5	12	7
HF161F	50pcs/tray	40 x 27 x 20	400	8.4	9.9	8
HF161F-W	50pcs/tray	40 x 27 x 20	400	8.4	14	6
HF162F	50pcs/box	40 x 27 x 18	400	8.4	14	5
HF163F-L	40pcs/tube	48.5 x 17 x 18.5	1000	7	9.3	8
HF165F	35pcs/reel	40 x 27 x 20	280	7.9	9.19	8
HF165FD/HF165FD-G	40pcs/tray	40 x 27 x 20	400	8.9	10.4	7
HF166F	30pcs/tray	40 x 27 x 20	240	9.2	10.2	7
HF2100/HF2101	40pcs/tray	35 x 29 x 24	240	8.5	10	6
HF2110/HF2111	50pcs/tray	35 x 29 x 24	350	9	10.5	6
HF2120	40pcs/tray	35 x 29 x 22	200	6.5	8	6
HF2150/HF2151	40pcs/tray	40 x 27 x 22	400	8	9.5	6
HF2160/HF2161	35pcs/tray	40 x 27 x 22	350	8	9.5	6
HF7520	50pcs/box	47 x 33 x 18	1000	8.6	10.4	8
HF8565 (Shroud)	10pcs/box	40 x 31 x 22	90	10.2	12	6
HF8565 (Twisted wire)	20pcs/box	35 x 30 x 24	40	4.4	6	6
HFE7	30pcs/tube	54 x 20 x 14	1200	7.2	10.2	8
HFE7	100pcs/box	36 x 26 x 25	1000	6	7.1	6
HFD2	25pcs/tube	58 x 29 x 24	4000	18	24	4
HFD3(SMT type)	400pcs/reel	35 x 35 x 18	2000	4	8	8
HFD3	40pcs/tube	68 x 19 x 23	4000	8	13	6
HFD4(SMT type)	900pcs/reel	37 x 37 x 22	3600	2.9	8	6
HFD4	50pcs/tube	58 x 18 x 16	4000	3.2	9	9
HFD23	20pcs/tube	35 x 29 x 24	4000	8.8	10.8	6
HFD27	25pcs/tube	58 x 29 x 24	4000	20	27	3
HFD31	40pcs/tube	64 x 22 x 20	4000	12.8	15	6
HFD31(SMT type)	550pcs/reel	37 x 37 x 20	2200	7	8.8	7
HFD3-V(SMT type)	400pcs/reel	35 x 35 x 18	2000	4	8	8
HFD3-V	40pcs/tube	68 x 19 x 23	4000	8	13	6
HFD41/HFD41A	100pcs/box	45 x 32 x 18	2000	7	8.8	8

Notes: This above list is the typical packing specification. Specifications and dimensions in this catalog are subject to change without notice.

Type	Packing Method	Carton Size L x W x H cm	QTY/CTN PCS	Approx. N.W. kg	Approx. G.W. kg	Stacking Layers Limit n
HFD42	50pcs/tube	62 x 17 x 18	4000	3.2	9	9
HFD42(SMT)	500pcs/reel	37 x 37 x 22	2000	1.6	7.4	9

Notes: This above list is the typical packing specification. Specifications and dimensions in this catalog are subject to change without notice.



HONGFA RELAY

ISO9001、ISO/TS16949、ISO14001、OHSAS18001、IECQ QC 080000 CERTIFIED

Explanation To Terminology And Guidelines

Preface	302
Chapter 1 The Basic Terminology Of Relays	303
1. Contact Parameters (the output of the relays)	303
2. Characteristics Parameters	304
3. Coil Parameters (the input of the relays)	306
4. Safety Approval	306
5. Ordering Code	307
6. Outline Dimensions, Wiring Diagram And The Size Drawing Of The Mounting Holes	307
7. Characteristic Curves	307
8. Monostable, Latching And Polarized Relays	308
Chapter 2 The Principles Of Selecting The Relays ---	309
Chapter 3 Precautions For Applying The Relays	315
Chapter 4 Quick Zoom Table For Reasons For Failure	332
Chapter 5 Ordering Example	333

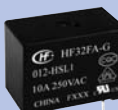
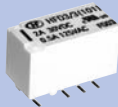

PREFACE

1. Principles

HF and its affiliates have made every effort to guarantee the accuracy of instructions and specifications. Still, errors may occur. Therefore, HF and its affiliates reserve the right to make any modification to the instructions and specifications.

HF and its affiliates claim only the responsibility of the clearly confirmed experiment clauses and condition of sale as well as the application condition and test results stated in particular specifications. We disclaim any assumptions or implications of any of our specifications and instructions.

Given the impossibility of defining all the requirements of all the relays in every application, users shall select relays accordingly and re-check through careful evaluation, or turn to HF and its affiliates for technic support if necessary. Users shall take full responsibility for relay selection.

2. Definition and Classification

Relay is a kind of component by which when the input is reached to a certain value, one or more outputs will produce the scheduled changes.

For electromagnetic relay, SSR and combined relay, it can be simply understood as the following way: it is a switch by which in the input end the speculated electrical signals are applied, the output end makes or breaks the controlled circuit.

There are many kinds of classifications about relay, we take the following classifications shown as table 1.

Table 1

Classifications		Application Fields	Advantages
Electromagnetic Relay	Signal relay	Generally for telecom and signal control	<ul style="list-style-type: none"> ● Without leakage current in the open output end ● In the large load, it is unnecessary to add the radiators
	Power relay	Generally for home application	
	Industrial relay	Generally for industrial application	
	Latching relay	Generally for power control	
	Automotive relay	For automotive fields	
	Hermetically sealed relay	For the fields where the environment is bad and the high reliability is required	
SSR & Power Module		For the fields where the environment is bad, low noise and high reliability are required.	<ul style="list-style-type: none"> ● With long electrical endurance ● Without noise ● Good shock and vibration capability
Combined Relay		For the fields where the certain control functions are required.	<ul style="list-style-type: none"> ● With certain control logic



HONGFA RELAY

ISO9001, ISO/TS16949, ISO14001, OHSAS18001, IECQ QC 080000 CERTIFIED

According to the classifications of relay, our catalogue can be divided into general relay fascicule, automotive relay & module fascicule, industrial relay fascicule, latching relay fascicule and hermetically sealed relay fascicule. In general relay fascicule, power relay and signal relay are included; and in automotive relay & module fascicule, plug-in relay, PCB relay and automotive module are included. We also provide the sockets which match to the relays.

This article states the basic information about the electromagnetic relay, lists the selecting principles and cautions of applications.

Generally the parameters of the instructions in the catalogue are the measured initial values under the standard, which are as following, unless otherwise stated.

- 1) temperature: 15°C to 35°C
- 2) relative humidity: 25% to 75%
- 3) air pressure: 86kPa to 106kPa

Generally the drawing stated in the catalogue is the first quadrant projection way as shown in figure 1, unless otherwise stated.

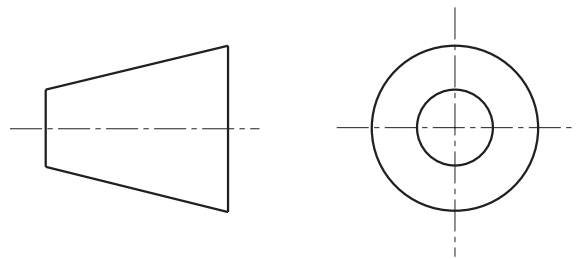

Figure 1

CHAPTER 1 THE BASIC TERMINOLOGY OF THE RELAYS

1. Contact Parameters

1.1 **Contact forms** are the arrangements of relay contacts. The basic contact arrangements are shown in Table 2, the multi-contact arrangements can be ratiocinated.

Table 2

Name	Symbol	Alphabet Letter	
		China	Others
Normally Open Contacts		H	A (or NO)
Normally Closed Contacts		D	B (or NC)
Change-Over Contacts		Z	C (or CO)



HONGFA RELAY

ISO9001, ISO/TS16949, ISO14001, OHSAS18001, IECQ QC 080000 CERTIFIED

- 1.2 Contact resistance** is the total resistance between the contacts, the terminals and spring jointed with contacts, generally shown in $m\Omega$.
Unless otherwise stated in the catalogue, generally for the relay with contact load below 2A, its contact resistance is measured in 6Vd.c., 0.1A; for the relay with contact load above 2A, its contact resistance is measured in 6Vd.c., 1A. contact resistance should be tested with the max applicable voltage and current according to the corresponding load type in IEC61810-7.
- 1.3 Contact voltage drop** generally is, in the load circuit, the total voltage drop between contacts, springs jointed with contact and the terminals. It is generally described as the voltage drop value under the regulated current, for example 50mV (measured in 10A).
- 1.4 Contact material** is the material used in contacts and generally shown in chemistry formula, for example, AgNi represents silver-nickel alloy contacts. The material used in the relay, its characteristics and its application environment can be seen in 1.2 'Contact material' in chapter 2 'the principles for selecting relays'.
- 1.5 Contact rated load** generally refers to the load of which the contacts can switch reliably under the certain regulated conditions. Generally it is shown as the combination of the voltage and the current. The loads listed in the catalogue are resistive loads, unless otherwise stated.
- 1.6 Max. switching voltage** is the maximum load voltage of which the contacts can switch. In general application, this voltage value shall not be surpassed, or the relay endurance will be reduced.
- 1.7 Max. switching current** is the maximum load current of which relay contacts can switch. In general application, this voltage value shall not be surpassed, or the relay endurance will be reduced.
- 1.8 Max. switching power** is the maximum load power of which relay contacts can switch reliably. Generally for AC it is shown in VA while for DC it is shown in W.
- 1.9 Mechanical endurance** refers to the operations that the relays without load or with load do not lead to failure under the rated voltage, normally switch in the specified, generally it is shown in operations.
- 1.10 Electrical endurance** generally refers to the operations that the relay can normally switch when the specified load is applied on the contacts and the rated voltage is applied to the coil under the conditions that the relay is placed in the certain speculated environment. Generally it is shown in operations.
- 1.11 Surge current** generally refers to the maximum transient current of which relay can endure in the specified load.
- 1.12 Min. applicable load** generally is reference value of minimum load that the relay can switch. Please perform the confirmation test with actual load before production since reference value may change according to switching frequency, environmental condition and expected contact resistance and reliability.

2. Characteristics Parameters

- 2.1 Insulation resistance** is the impedance when the conductors insulated with insulating material are applied to voltage and it is generally shown in " $M\Omega$ ". The speculated voltage described above are general 500Vd.c.(or 250 Vd.c.).
- 2.2 Dielectric strength** is the voltage value when, within the speculated time, the conductors insulated with insulated material are applied to the voltage and the leakage current is less than the speculated current. The certain voltage above generally is the effective value of AC voltage and unless otherwise stated, the leakage current is generally less 1mA.
- 2.3 Operation time** refers to, with the relay in the released state, the elapsed time from the initial application of power to the coil, till the closure of the normal open contacts. It does not include any bounce time, and expressed in "ms".
For the latching relays, operation time refers to, with the relay in the reset state, the elapsed time from the initial application of power to the coil, till the closure of the normal open contacts. Seen in figure 2.



HONGFA RELAY

ISO9001, ISO/TS16949, ISO14001, OHSAS18001, IECQ QC 080000 CERTIFIED

GUIDELINES OF RELAY

2.4 Release time refers to, with the relay in the operation state, the elapsed time from the initial removal of coil power till the re-close of the normal closed contacts. It does not include bounce time and expressed in "ms". Seen in figure 2.

2.5 Reset time (only for the latching relays) refers to, with the relay in the operation state, the time from the first application of power to the reset coil till the re-close of the normally closed contacts. Seen in figure 2.

2.6 Bounce time generally refers to the time from the initial close of the contacts till the complete close and generally expressed in "ms". Seen in figure 2.

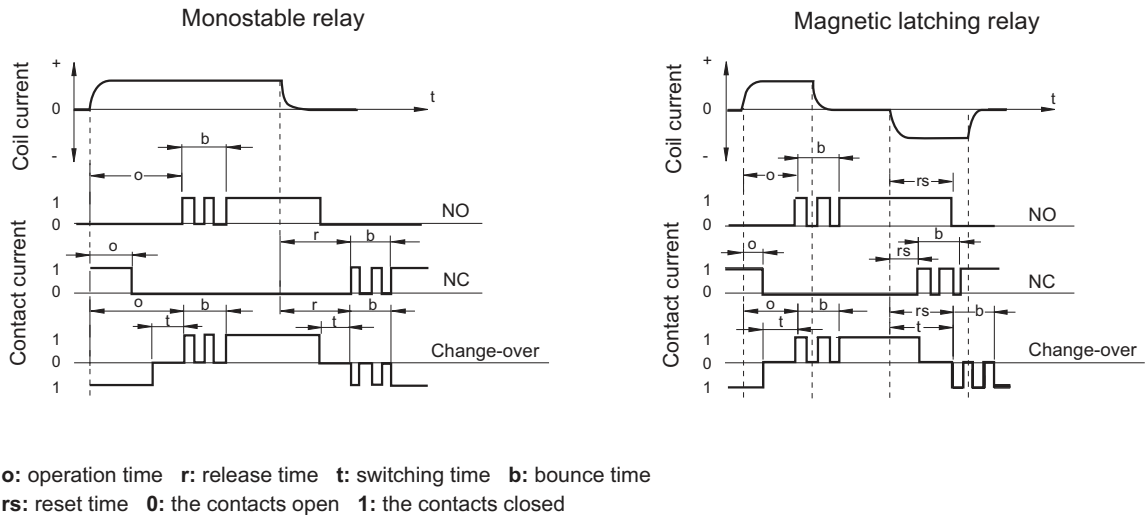

Figure 2

2.7 Switching frequency refers to the cycling times of the operation and release in united time.

2.8 Ambient temperature refers to the temperature in which the relay can normally be applied and it is generally expressed in the range of temperature.

2.9 Coil temperature rise refers to the temperature that the coil rises by after the temperature becomes stable and under the conditions that in the suitable maximum ambient environment the rated voltage is impressed on the coil and the rated load is impressed on the contacts. Generally it refers to the maximum value, expressed

2.10 Shock is divided into shock functional and survival.

Shock functional refers to the acceleration the relay can suffer the shock value under the condition of the NC contact open time and open contact closing time at specified time. Usually it is expressed in the combination of the acceleration value "g" and the duration "ms".

Shock survival refers to the shock value that can not damage the relay construction, Usually it is expressed in the combination of the acceleration value "g" ($1g=9.8m/s^2$) and the duration "ms".

2.11 Vibration resistance is divided into Vibration function and survival.

Vibration function refers to the vibration the relay can suffer without causing the closed contacts to open for more than the specified time and the open contacts to close for more than the specified time. It is usually expressed in the combination of the vibration "mm" and the vibration frequency "Hz".

Vibration survival refers to the vibration the relay can suffer without damaging their construction. It is usually expressed in the combination of the vibration "mm" and the vibration frequency "Hz".



HONGFA RELAY

ISO9001, ISO/TS16949, ISO14001, OHSAS18001, IECQ QC 080000 CERTIFIED

2.12 Humidity refers to the required humidity in which the relay can reliably work and generally expressed in relative humidity "%RH".

2.13 Model Of The Terminals

The terminals model of the relays also shows the applicable fields. Generally speaking, the models of terminals are PCB, THT, SMT, plug-in, QC and others.

2.14 Weight : the weight of the relay.

2.15 Enclosure type refers to the protection mode for the relay body. It is divided into enclosed, dust protected, flux proofed, plastic sealed and hermetically sealed. Seen in 3.1 'mode of encapsulation' in chapter 2 'the principles of selecting the relays'

3. Coil Parameters

3.1 The rated coil power refers to the power consumed by the coil when the coil are applied to the rated voltage. Generally for the DC relay, it is expressed in W while for the AC relay in VA.

3.2 Rated voltage is the voltage applied to the coil that can make relay work normally. It is expressed in "V". For the polarized relay, the direction in which the voltage is impressed should be notified.

3.3 Operate voltage is the voltage which closes the NO contacts when the relay is in the releasing state (for the latching relay in the reset state) and the coil voltage is increased gradually. Usually it is expressed in "V". It is usually the maximum value listed in the instructions, which is about 80% of rated voltage.

3.4 Release voltage is the voltage which closes the NC contacts when the relay is in the operation state and the coil voltage is gradually reduced from the rated voltage. It is usually expressed in "V". The minimum value is listed in the instructions, which is about 10% of the rated voltage.

3.5 Reset voltage is the voltage which closes the NC contacts when the latching relay is in the operation state and the reset coil voltage is increased. It is expressed in "V". The maximum value is listed in the catalogue, which is about 80% of the rated voltage.

3.6 Coil resistance generally refers to the DC resistance and is expressed in " Ω ". In the catalogue the combination of the nominal value and tolerance is given.

3.7 Maximum voltage refers to the maximum voltage which relay coil could endure in a short period of time. It is expressed in V.

4. Safety Approval

4.1 UL Approval

UL, the abbreviation of Underwriter Laboratories Inc, is a non-profitable organization founded in 1984. The electrical products authorized by this organization can be freely sold in American market, while the electrical products not authorized by this organization will be limited when they are sold in most of the states of America. Due to the authority of UL, the products approved by UL are accepted by many countries.

4.2 CSA Approval

CSA, the abbreviation of Canadian Standards Association, is the authorized approval institution. The electrical products approved by this institution can be freely sold in Canadian market. The products approved by the CSA can be only sold in Canadian market and if these products want to enter into the American market, they should get the American approval of UL.

4.3 UL&CUR

UL&CUR is the approval which simultaneously meets the American standard and the Canadian standard and can be used in North America.



HONGFA RELAY

ISO9001, ISO/TS16949, ISO14001, OHSAS18001, IECQ QC 080000 CERTIFIED

4.4 VDE Approval

VDE, the abbreviation of Verband Deutscher Elektrotechniker, is one of Germany authorized organizations in electrical component and other equipment. The electric products approved by this institution will be admitted in Germany law.

4.5 TÜV Approval

TÜV, the abbreviation of Technischer überwachungsverein, has the same authority as VDE. TÜV is one of the authorized institution in electric equipments. The electric products approved by this institution will be admitted in Germany law.

4.6 CQC Approval

CQC, the abbreviation of China Quality Certification, is the most authorized approval institution in China. The products not listed in the catalogue of 3C approval can make CQC approval in China Quality Certification Center.

5. Ordering Code

Ordering code is a code which is used to ensure the type and the specifications of the relay, which includes the basic information of relay, such as the type of the products, coil voltage, contacts arrangement, enclosure type etc.. The ordering code of HONGFA brand relay can be seen in Chapter 5 "the ordering code".

6. Outline Dimensions, Wiring Diagram And The Size Drawing Of The Mounting Holes

Ordering mark is a mark which is used to ensure the type and the specifications of the relay, which includes the basic information of the relays, such as the type of the products, the coil voltage, contacts arrangement, the mode of encapsulation etc.. The ordering marks of HONGFA brand relay can be seen in Chapter 5 "the ordering marks".

6.1 Outline dimensions describes the drawing of the relay outline size and the mounting space needed by relay.









6.2 Wiring diagram describes the wiring way of the input and output terminals respondent to the terminals of the relays.

6.3 The size drawing of the mounting holes describes the position of the relay terminals and the size of their mounting holes.

6.4 Examples

The examples of the common components can be seen in table 3.

Table 3

Coil	Polarized Coil	Contact	Resistance	Capacitance	Diode	Zener Diode	LED	Varistor
								

7. Characteristic Curves

7.1 Max. switching power curves represent the loads the relay can support.

7.2 Electrical Endurance Curve: The electrical endurance curve indicates the typical endurance under rated load. The data of all the electrical endurance do not guarantee a minimum value.

- 1) The data of all the electrical endurance are only valid for stated contact materials, special contact materials excluded. No deductions should be made from the data.
- 2) No deductions should be made from the data, especially to the situation when the current is below 0.5A as contact wear is not the dominant failure mode.

7.3 **Coil temperature rise** curve shows the measured temperature rise value of the coil when the relay is energized with different voltage and loads under the speculated ambient temperature.

8. Monostable, Latching And Polarized Relays

8.1 Monostable Relay:

For this relay, the contacts operate when the coil is energized while the contacts will reset when the coil is deenergized.

8.2 Latching Relay:

For this relay, the contacts operate when the coil is energized while the contacts will keep the state when the coil is deenergized. To reset the contacts, the counter-energization will be applied to the single-coil coil or the energization is applied to the double-coil reset coil .

8.3 Polarized Relay:

The switch of the contact state is dependent on the polarity of the energized voltage in the terminals of the coil. Part of the monostable relays and all the magnetic latching relays belong to polarized relays.

The basic circuit and operating wave of the several common relays can be seen in table 4.

Table 4

Type	The Basic Circuit And Operating Waveform		
Non-Polarized Monostable			
Polarized Monostable			
Single-coil Latching			
Two-coil Latching			

Notes: the voltage with the correct polarity is required to impress on the coil of polarized relays or the relays will not work, as shown in the shaded area in the figures above.



HONGFA RELAY

ISO9001, ISO/TS16949, ISO14001, OHSAS18001, IECQ QC 080000 CERTIFIED

CHAPTER 2 THE PRINCIPLES OF SELECTING THE RELAYS

In order to correctly select relays, customers need know the characteristics of the relays to ensure whether these characteristics meet with the practical requirements. It will be more reliable if these characteristics can be tested in the practical environment. The principles of selecting relays can be seen in table 5. In table 5, in the column "must be confirmed" the item with mark \checkmark is confirmed and a type of relay can be selected. If there is further requirement, the correspondent items with the mark \checkmark are required to be further confirmed.

Table 5

Item		The considered points	Confirmed	Reference	Influence factors
Contact	Contact load	AC, DC, size and types (inductive or resistive)	\checkmark		<ul style="list-style-type: none"> the ambient temperature as for AC load, is the operation and the load synchronous or not Does the contact material match the load?
	Contact arrangement	NO or NC or switching? how many pairs of the contacts?	\checkmark		
	Electrical endurance	The frequency and the expected operation times?	\checkmark		
	Contact material	Which material?		\checkmark	
	Contact resistance	How much and the testing conditions?		\checkmark	
Coil	Rated voltage	How much, direction, AC, DC?	\checkmark		<ul style="list-style-type: none"> the ambient temperature the power fluctuation the voltage drop driven by semi-conductor
	Coil resistance	How much? The input power consumption?	\checkmark		
	Operate voltage	How much? The influence of the power wave?		\checkmark	
	Release voltage	How much? The influence of the power fluctuation?		\checkmark	
	Max. allowable voltage	How much? How long?		\checkmark	
	Coil temperature rise	How much? Insulation level?		\checkmark	
Performance	Enclosure type	Unenclosed type, dust protected, flux proofed, or plastic sealed?	\checkmark		<ul style="list-style-type: none"> the ambient atmosphere the safety requirements
	Dielectric strength	How much? where?	\checkmark		
	Insulation resistance	How much? where?		\checkmark	
	Vibration resistance	How much? Functional or destructive?		\checkmark	
	Shock resistance	How much? Functional or strength?		\checkmark	
Practical Environment	Ambient temperature	High or low? How long?	\checkmark		<ul style="list-style-type: none"> insulation level method of encapsulation the life
	Atmosphere	Humidity? Harmful gases ?		\checkmark	
Outline And Mounting	Outline	Size and dimension	\checkmark		<ul style="list-style-type: none"> the required mounting size mounting method
	Type Of Terminals	PCB, QC, plug-in or screw fixed model?	\checkmark		
	Welding mode	Manual solder, wave solder, reflow solder ? Is cleaning needed or not?		\checkmark	
	Mounting gap	Cling or with gap?		\checkmark	
Others	Safety approval	UL、VDE、TUV、CQC etc ?		\checkmark	<ul style="list-style-type: none"> zone the customers' requirements
	Special requirements and conditions	The requirements of the customers		\checkmark	

The following will give the further explanation about the items in the table above.



HONGFA RELAY

ISO9001, ISO/TS16949, ISO14001, OHSAS18001, IECQ QC 080000 CERTIFIED

1. Contact Parameters

1.1 Contact Load

Before ensuring whether the load the relay can carry in order to meet with the application, we should confirm the type of the real load except for confirming the load value for different loads have different steady state value and inrush value. Seen in table 6. The load given in the instructions are generally the resistive load, unless otherwise stated.

Table 6

The Type Of Load	Inrush Current
Resistive Load	once steady state current
Motor Load	5-10 times steady state current
Capacitive Load	20-40 times steady state current
Transformer Load	5--15 times steady state current
Solenoid Load	10--20 times steady state current
Incandescent Lamp Load	10-15 times steady state current
Mercury Lamp Load	3 times steady state current
Sodium Vapor Lamp Load	1-3 times steady state current

Figure 3 shows the relations between the representative load and the inrush current. In addition, according to the characteristics that the polarity of different moving and stationary contacts will influence the electrical endurance. Please check in the practical application or consult the technician of HONGFA company.

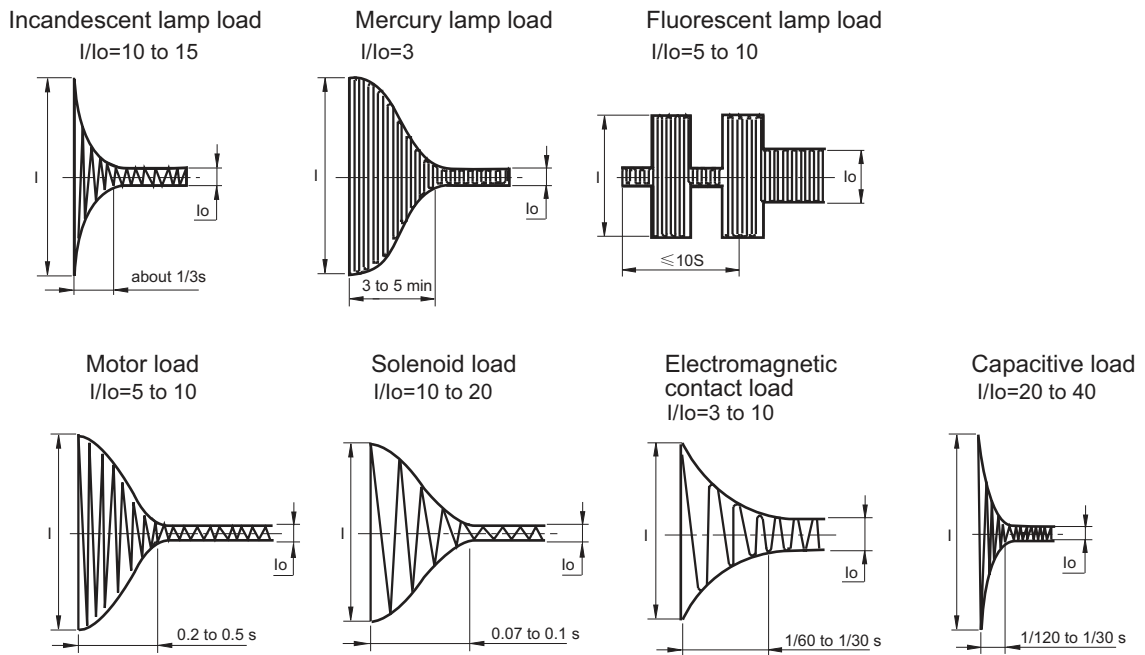

Figure 3

1.2 Contact Material

For the same type of relay, different contact materials are applicable to different load types or ranges. Seen in table 7.



HONGFA RELAY

ISO9001, ISO/TS16949, ISO14001, OHSAS18001, IECQ QC 080000 CERTIFIED

GUIDELINES OF RELAY

Table 7

Material	Feature	Typical Application
AgNi+ Au (gold plating)	<ul style="list-style-type: none"> ● gold plating with good resistance to erode in the air ● by contrast to other material, lower contact resistance and better consistency in low load ● high electrical conductivity and thermal conductivity 	<ul style="list-style-type: none"> ● Small load: gold plating almost not eroded, from 10mW(5V, 2mA) to1.5W (24V, 62.5mA) (resistive load) ● Middle load: gold plating is eroded after seve operations and AgNi functions mainly, from 2.4W (24V, 100mA) to 60W (30V, 2A) (resistive load) <p>Note: Break the low load, the typical value is 1mW (0.1V 1mA) (eg. in the testing devices); Suggest to use two pairs of the contacts in parallel.</p>
AgPd	<ul style="list-style-type: none"> ● good resistance to erode and sulfur in room temperature ● low contact resistance and good consistency ● expensive 	<ul style="list-style-type: none"> ● the same as the above
AgNi	<ul style="list-style-type: none"> ● the standard material of most contact material ● high electrical conductivity and thermal conductivity ● high resistance to burn ● average resistance to solder ● easily produce the sulfured film in the atmosphere with sulfid. 	<ul style="list-style-type: none"> ● resistive load and low inductive load ● rated current below 12A ● surge current below 25A
AgCdO	<ul style="list-style-type: none"> ● high AC load ● high electrical conductivity and thermal conductivity ● good resistance to burn ● great resistance to welding ● easily produce the sulfured film in the atmosphere with sulfid 	<ul style="list-style-type: none"> ● resistive load, motor load and inductive load ● rated current below 30A ● surge current below 30A
AgSnO ₂	<ul style="list-style-type: none"> ● great resistance to welding ● the materials transferred less than those above3 in DC load ● easily produce the sulfured film in the atmosphere with sulfid. 	<ul style="list-style-type: none"> ● lamp load, inductive load and capacitive load ● excessively high surge current load (up to 120A)
AgSnO ₂ (with other oxide matter)	<ul style="list-style-type: none"> ● the same as the above 	<ul style="list-style-type: none"> ● lamp load, inductive load and capacitive load ● excessively high surge current load (up to 120A) ● with different oxide matter, the different applicable load

Notes:

- 1) Consider the maximum current value specified in different relays.
- 2) It would be better to be checked and tested in application when the conditions are catalogue allowable.
Gold plating of the contacts shows good performance for the low loads. However, for the high load, it can only keep the initial contact performance of the contacts before the relays are used.



HONGFA RELAY

ISO9001, ISO/TS16949, ISO14001, OHSAS18001, IECQ QC 080000 CERTIFIED

1.3 Electrical Endurance

Unless otherwise specified, the electrical endurance in the instruction refers to the standard value under rated load in the circumstance that:

- a) standard condition
- b) NO contact
- c) 50Hz for AC load
- d) Make-break rate 1:9
- e) Resistive load
- f) Flux-proof
- g) Downwards PCB terminals
- h) Separated installation
- i) See severity level B according to IEC 61810-7 for failure modes
- j) See IEC 61810-7 for unstated information

Considering the flux-proof and the dust-proof types have longer electrical endurance than the sealed type of the same relay, it is preferred to select the flux-proof and the dust-proof types if possible.

1.4 Mechanical Endurance

Unless otherwise specified, the mechanical endurance in the instruction refers to the standard value under rated load in the circumstance that:

- a) no contact load
- b) Rated frequency of operation, duty factor 50%
- c) Downwards PCB terminals
- d) 50Hz for AC load
- e) See IEC 61810-7 for failure modes

2. Coil

2.1 Voltage

To make the relay work reliably, be sure that work circuit can supply the rated voltage to the coil.

In the case of transistor drive circuit, that the voltage on the coil is less than the normal voltage of the transistor drive circuit because of the voltage drop on the transistor, it is recommended to use 4.5V type relay which in 5V transistor circuit and 2.4V type relay in 3V transistor circuit.

Sometimes to shorten the operating time, the coil can be applied to maximum allowable voltage to the coil in the short time. However it should be ensured that the relay will not overheat or even be damaged.

For polarized relays, please check the polarity of the coil voltage.

2.2 Coil Resistance

To make the relay work reliably, be sure that work circuit supplies the nominal coil power consumption to the relay. Therefore please select the suitable coil resistance.

3. Performances

3.1 Enclosure Type

To ensure the reliability of the relay, different ways of encapsulation will require different post-processing(table 8).

Table 8

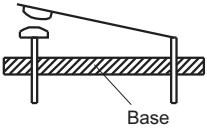
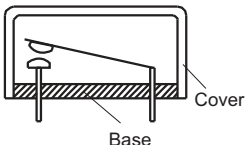
Type	Construction	Features	Auto- matic Solder	Auto- matic Clean- ing	Dust Resis- tance	Liquid Proof	Harmful Gas Resis- tance
Un- enclosed		Without the protective case	X	X	X	X	X
Dust Protected		With the dust protective case; the case and the base are fitted together and their joint is close to PCB.	X	X	√	Δ	X



HONGFA RELAY

ISO9001, ISO/TS16949, ISO14001, OHSAS18001, IECQ QC 080000 CERTIFIED

GUIDELINES OF RELAY

To be continued

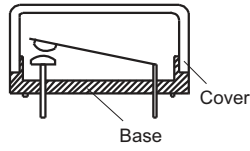
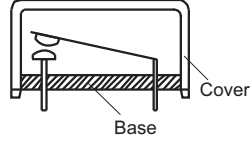
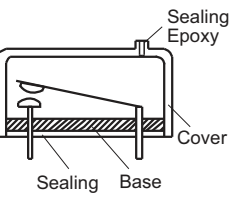
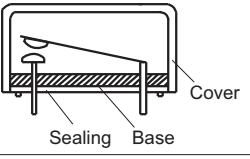
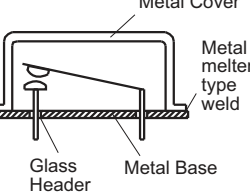
Type	Construction	Features	Auto matic solder	Auto matic clean ing	Dust resist ance	Liquid proof	Harmful Gas Resis tance
Flux Proofed		<p>With the dust protective case; the case and the base are fitted together and their joint is close to PCB.</p> <p>The terminals are plastically sealed on the base or the base and the terminals are fitted with sealing epoxy; the fitted joint is far from PCB.</p> <p>Without exceeding the scheduled position, the flux will not penetrate the relay.</p>	√	X	√	Δ	X
		<p>Without exceeding the scheduled position, the flux will not penetrate the relay.</p>					
		<p>Base, terminals and case are fitted with sealing epoxy; there is ventilating hole far from PCB.</p> <p>Without exceeding the scheduled position, the flux will not penetrate the relay.</p>	√	X	Δ	Δ	X
Plastic Sealed *		<p>Base, terminals and case are fitted with sealing epoxy; The internal of the relay is sealed in the case and base. Washable in limited condition.</p>	√	√	√	√	√
Sealed or Hermetically		<p>Metal case and metal base are sealed; terminals and base are sealed with glass.</p> <p>The leakage rate of the air in the internal of the relay meet with the requirements.</p>	√	√	√	√	√

Notes:

- 1) "√" means good; "x" means not good; "Δ" means to notify.
- 2) Because the plastic has the certain leakage, please use hermetic relays in the conditions that there are harmful gases or the explosive proof is required.
- 3) * Hongfa recommends to implement washing-free soldering process to avoid washing on relay, ultrasonic cleaning is prohibited. If water cleaning is required after the relay is assembled on PCB, it is a must that you should get contact with hongfa and specify detailed washing method, we'll help you to choose suitable product.

3.2 Dielectric Strength And Insulation Resistance

Please confirm that these two parameters can meet the application requirement and will not lead to such conditions as the breakdown of the circuit, short circuit.

3.3 Vibration Resistance And Shock Resistance

Please confirm that these two parameters can meet the application requirement and will not lead to the failure of the relay in the course of the application.

4. Temperature

4.1 Ambient Temperature

Generally speaking, when the temperature does not exceed temperature range speculated in the catalogue, the relay can normally work. When the temperature in application is higher than the temperature speculated in the instructions, please contact Hongfa to ensure whether the relay can be normally used according to the loads.

4.2 Atmosphere



HONGFA RELAY

ISO9001, ISO/TS16949, ISO14001, OHSAS18001, IECQ QC 080000 CERTIFIED

In the atmosphere with high humidity, moisture, even freezing dew and much dust, recommend to use sealed relays. Under high humidity, it would easily accelerate the rust of the relay parts and the dust easily result in the failure of the relay contacts.

In the atmosphere with organic silicon, unsealed relays shall not be used for the organic silicon will accelerate the failure of the contacts. In the atmosphere with moisture and harmful gases as H₂S、SO₂、NO₂ etc., the flux proofed and dust protected products can not be applied while the plastic sealed products can be used and tested in application.

In application, if the ambient atmosphere is better, recommend to use the dust protected and flux proofed relays for they can get the longer electric endurance than plastic sealed relays.

5. Outline And Mounting

5.1 Outline And Mounting Gap

The outline sizes of the relays usually have a certain tolerance. Therefore when the circuit and the mounting gap are designed, the design is suggested to be done according to the maximum size in the instructions.

5.2 Welding Methods

Since July 1st, 2006, the terminals of the relays produced have been lead-free. The suggested welding temperature and time are respectively 240°C to 260 °C, 2s to 5s.

If reflow solder is required, it should be confirmed the relay can be reflow soldered according to the instructions.

If you have questions, please contact Hongfa.

5.3 The Model Of The Terminals

Select the suitable shapes of the terminals and mounting methods according to the real conditions.

Table 9







Classification	PCB (THT)	(SMT)	(Plug-in)	(QC)	(Screw)
Terminals type					
Representative products	HFD27 HF115F HFKC	HFD3	HF13F HF18FF	HF105F HFV7 HF3501	HF116F-3

Table 10

Classification	PCB Mounting			Plug-in Mounting	Screwing Mounting
	THT	SMT	THT and QC		
Mounting type					
Representative products	HFD27 HF115F HFKC	HFD3	HF102F HF105F-4 HF2160	HF13F HFV7 HF18FF HF3501	HF105F-4 HF92F HF116F

6. Others

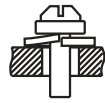
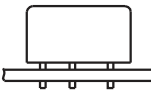
6.1 Safety Approval

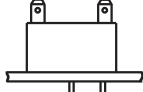
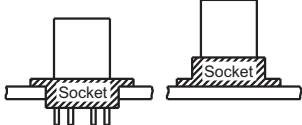
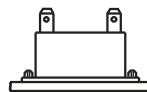
Generally UL/CUR approvals are applicable in North America and VDE&TÜV approvals are applicable in Europe. However, due to the international authority of these approvals, most of countries also accept them. If you have questions, please contact Hongfa.

6.2 Special Requirements

Except for normal products, we accept the customer's order for the products with special specifications. Please contact Hongfa when required.



HONGFA RELAY

ISO9001, ISO/TS16949, ISO14001, OHSAS18001, IECQ QC 080000 CERTIFIED

CHAPTER 3 PRECAUTIONS FOR APPLYING THE RELAY

To properly use the relay, when the relay is selected and its characteristics are learnt, the precautions for using are required to be known and ensure the reliable operation of the relay.

The following precautions will be considered in application:

- 1) The relays are used within the range of the parameters listed in the catalogue, to the extent that it is possible.
- 2) The rated load and the life are the referent values, which will be different due to the different environments, load features and types. Therefore they should be tested in the practical or stimulated application.
- 3) DC relays are controlled by rectangle wave to the extent that it is possible while the AC relays are controlled by sine wave.
- 4) To maintain the performances of relays, please do not make the relay drop or be shocked strongly. Suggest that the relays dropped not be used.
- 5) Relays are used in the ambient temperature and normal humidity and in the atmosphere with less dust and harmful gas. The harmful gases include gases with sulfur, silicon and nitrogen oxide etc.
- 6) For the latching relays, please set them in the operate or reset state before they are used. Please pay attention to polarity and pulse width when energizing on the coil
- 7) For polarized relay, please notify the polarity (+, -) of the coil voltage.
- 8) Except for the above there are other precautions. In the following they will be described one by one in the order listed in table 2.

1. Precautions For The Contacts

Contacts are the most important elements of relay construction. Contact life is influenced by contact material, voltage and current value applied to the contacts (especially the voltage and current waveforms at the time of application and release), the type of load, switching frequency, ambient atmosphere, form of contact and the contact bouncing etc. The material transfer, welding, abnormal usage and the increase in contact resistance bring about the failure of the contacts. Please pay attention to them in application.

In order to better apply the relay, please refer to the following precautions of the contacts.

1.1 The Load

The resistive load value is usually listed in the catalogue, however, which is not enough. It should be checked and tested in the practical contact circuit.

The minimum load described in the instructions is not the standard lower limit value the relay can switch reliably. The reliability of this load value is different due to differences of the ON-OFF frequency, the environment, the change of the required CR and absolute values.

1.1.1 Voltage

When the inductive circuit is switched off, there are the reverse voltage which is higher than the electrical circuit. The higher this voltage is the more the energy is. Correspondently the contact wear and material transfer also increase. Therefore notify the load type and load value the contacts of the relay control.

In the same current, DC voltage value the relay can switch reliably is much less than AC voltage value for AC current exists zero point (the point when the current is zero) and the electrical arc produced easily extinguishes. However for DC current, the electrical arc extinguishes when the contact gap is up to the certain value. Therefore the duration of the arc is longer than that in AC current and the contact wear and material transfer increases.

1.1.2 Current

When the contacts are on or off, the inrush currents will greatly influence the contacts. For example, when the load is motor load or lamp load, the higher the inrush current when the contact is on, the more the contact wear and the material transfer increase, and the more easily lead to the contact weld and not to separate. Please check in practical application.

1.2 Precautions For The Application

1.2.1 Avoiding Switching Both The Large Load And The Micro Load In The Same Relay

When switching the high load, the scattered contact material is produced, which will attach to the contacts with the low load and lead to the failure of the contacts. Therefore, please avoid the same relay switching both the high load and the low load. If it is the only choice to do against this, when mounting please place the contacts switching the little load over the contacts switching the large load. However the reliability will be influenced.



HONGFA RELAY

ISO9001, ISO/TS16949, ISO14001, OHSAS18001, IECQ QC 080000 CERTIFIED

1.2.2 Precautions For The Two Pairs Of Contacts Connected In Parallel

When the two poles of contacts are connected in parallel, the reliability will be improved but the load capacity could not, for the two poles of contacts could not be opened or closed at the same time.

1.2.3 The Problems About Phase Synchronism Of contact Operation And AC Load

If the operation of the relay contacts is synchronized with the phase of the AC power and the contacts always make or break in the high load voltage, seen in figure 4, the contact weld or material transfer will increase to lead the relay to prematurely fail. Please check whether the random phase are used in actual application. When the relay is driven by timer, micro computer etc., it will appear the power phase synchronism.

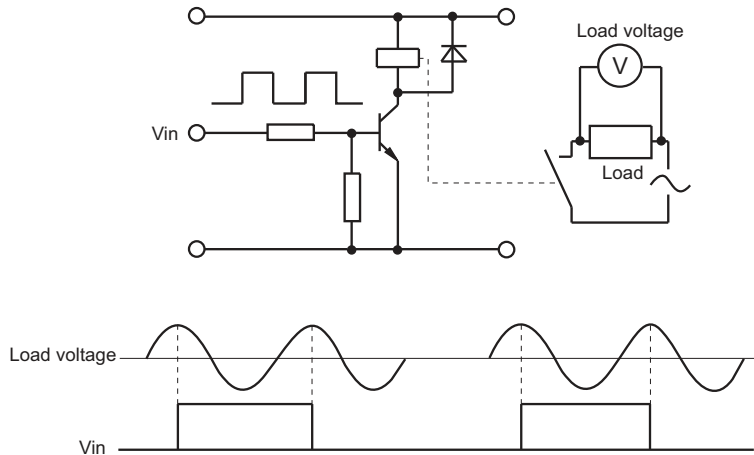

Figure 4

1.2.4 Electrical Endurance In The High Temperature

Electrical endurance of the relay will be lower in the high temperature than that in the low temperature. Please check while it is operating in the actual application.

1.2.5 Connection Of Multiple Pairs Of Contacts And The Load

Multi-contacts are arranged in the same polarity of the supply power to the extent that it is possible and the passive polarity in the other polarity of the supply power, as shown in figure 5 (a). Thus, the short circuits between the contacts, due to voltage differences between the contacts, can be possibly avoided. The wiring as shown in figure 5 (b) can be avoided.

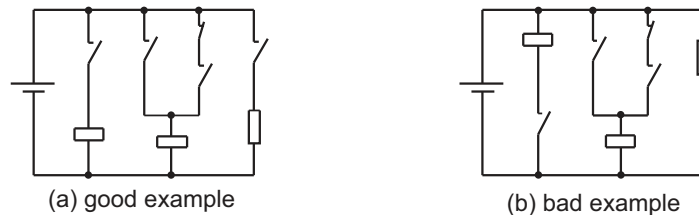

Figure 5

1.2.6 Avoid Short Circuit Caused By Contacts Weld And Electrical Arc

In the electrical circuit, the following points should be considered (seen in the figure 6)

- 1) Generally the gap between the contacts are small. The reason can probably be that the electrical arc between the contacts results in the short circuit. Please do not adopt the circuit shown in figure 6(b). The circuit shown in figure 6(a) is suggested to use and the certain interval can be set in the operation between Con1 and Con2.
- 2) It should be considered that the overcurrent should not be generated to make the circuit overload or burn when short circuit is caused by contact welding and error operation.
- 3) Care should be taken that the two pairs of switching contacts are not used to build the forward circuit and the reverse circuit, as shown in figure 6(d). Suggest that the circuit shown in Figure in 6(c) is applied and the certain interval is set in the operation between Con1 and Con2.



HONGFA RELAY

ISO9001, ISO/TS16949, ISO14001, OHSAS18001, IECQ QC 080000 CERTIFIED

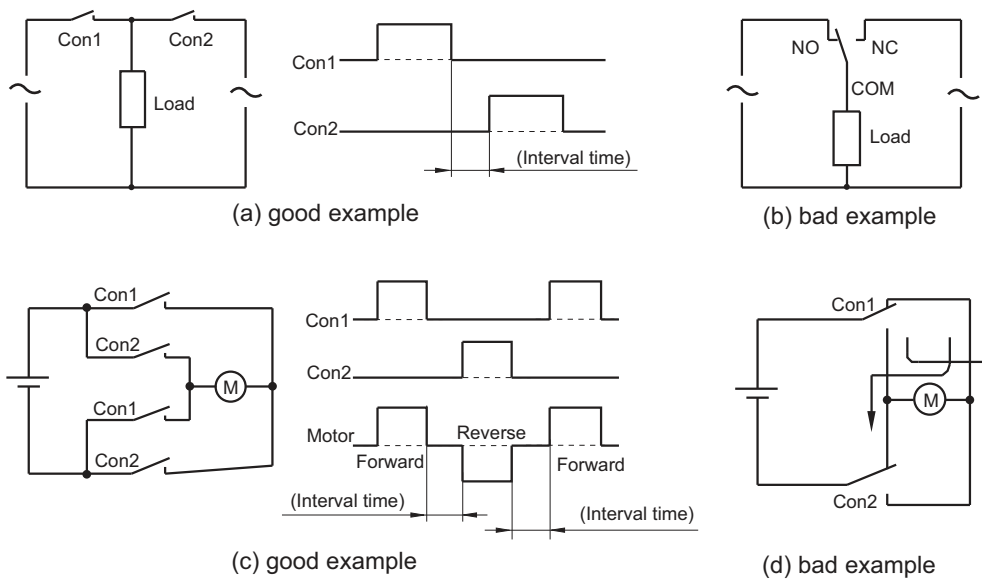

Figure 6

1.2.7 Avoid Short Circuit Between Contacts

The miniaturization of the electrical control equipments makes the control components tend to miniaturization, so the relay with multiple poles of contacts are used, care is taken of the differences of the voltage between the poles of contacts and load types. Suggest that large differences of the voltage among the contacts do not exist in order to avoid short circuit between poles of contacts.

1.2.8 Precautions For Using The Long Lead Wire

In the contact circuit of the relay, when the lead wire with more than 10m length is used, the inrush current will be generated due to the capacitance in the lead wire. Please connect in series the resistance (about 10 to 50) in the contact circuit, as shown in Figure 7.

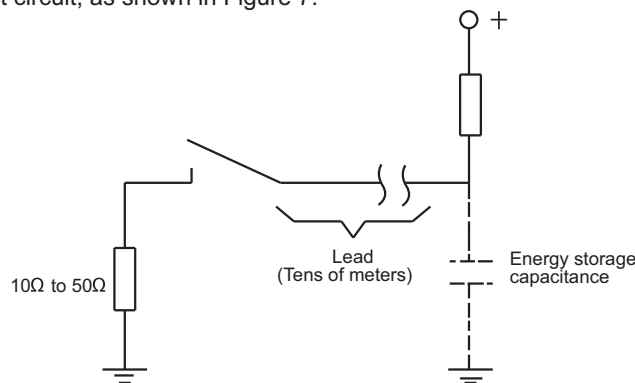

Figure 7

1.2.9 Precautions for the contacts of the magnetic latching relays

Generally the latching relays are shipped from the factory in the reset states. However during shipping or mounting relays the shock of the relay may change the operate state. Therefore suggest that in application it be set in the required state.

1.3 Contact Protection

1.3.1 Inrush Current And The Reverse Voltage

When the motor, capacitance, solenoid and lamp load make, the inrush current is generated, which is several multiple steady state currents.



HONGFA RELAY

ISO9001, ISO/TS16949, ISO14001, OHSAS18001, IECQ QC 080000 CERTIFIED

When the inductive load such as solenoid, the motor, contactor, the reverse voltage which are from hundreds of to thousands of volts. Generally in the normal temperature and atmospheric pressure the critical insulation destruction voltage of the air is 200 to 300V. Therefore if the reverse voltage exceeds this value, the discharge phenomena between contacts will happen.

Both inrush current and the reverse voltage will greatly damage the contacts and obviously shorten the relay life. Therefore the proper use of the contact protection circuit may increase the life of the relay.

1.3.2 Material Transfer Of Contacts

Material transfer of contacts refers to the transfer of the contact material from one contact to the other. When material transfer becomes serious, the accidented contact surface can be seen by eyes. As shown in figure 8, the accidented surface easily causes contact welding.

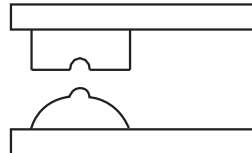

Figure 8

Generally, material transfer of contacts is caused by the one-way flowing of the large current or the inrush current of the capacitive load and often happens in DC circuit. Generally it shows the protruding shape in the passive polarity and the concave shape in the positive polarity. Therefore the proper use of the contact protection circuit or the use of AgSnO contact which has better resistance against material transfer may reduce the material transfer of contacts. The AC load with large capacity should be checked in actual application in the test.

1.3.3 The Protective Circuit Of The Contacts

Generally speaking, in contrast to resistive load, inductive load more easily damages the contacts. The use of properly protective circuit may make the influence of inductive load on the contacts equal to the influence of resistive load on the contacts. Care is taken that the incorrect use will generate the counter effect. Table 11 shows the typical examples of the contact protective circuit.

Table 11

Circuits Example	Application		Features	Device Selection
	AC	DC		
<div style="display: flex; align-items: center;"> <div style="writing-mode: vertical-rl; transform: rotate(180deg); margin-right: 10px;">CR Circuit</div> </div>	Δ	√	<ul style="list-style-type: none"> ● The supply voltage is usu. 24 to 48V. ● The load is a timer or a contactor, the release time lengthens ● If the load is a time, leakage current flows through the CR circuit causing faulty operation. ● If used with AC voltage, be sure the impedance of the load is sufficiently smaller than that of the CR circuit. 	<p>A: As a guide in selecting C and R</p> <p>C: 0.5 to 1μF per 1A contact current</p> <p>R: 0.5 to 1Ω per 1V contact voltage</p> <p>Values vary depending on the properties of the load and variations in relay characteristics; Please check by test.</p> <p>Capacitor C acts to suppress the discharge the moment the contacts open.</p>
<div style="display: flex; align-items: center;"> </div>	√	√	<ul style="list-style-type: none"> ● Applicable to the supply voltage of 100 to 200V ● If the load is a relay or a contactor, the release time lengthens. 	<p>The dielectric strength of the capacitor C is usu. 200 to 300V or more than two times the load voltage.</p> <p>Please use AC capacitor (non polaried) in AC circuit.</p>



GUIDELINES OF RELAY

To be continued

Circuits Example	Application		Features	Device Selection
	AC	DC		
Diode Circuit 	X	√	<ul style="list-style-type: none"> At the terminals of the inductive load the diode is connected in parallel, which can reduce the reverse voltage. The release time is longer than that in CR circuit. 	Select a diode with the reverse breakdown voltage at least 10 times the circuit voltage and a forward current at least as large as the load current. In electric circuits where the circuit voltages are not high, a diode can be used with a reverse breakdown voltage of about 2 to 3 times the supply voltage.
Diode And Zener Diode Circuit 	X	√	<ul style="list-style-type: none"> If the zener diode is added in the diode circuit the release time is reduced. 	Use a zener diode with a zener voltage about the same as the supply voltage.
Piezo Resistance Circuit 	√	√	<ul style="list-style-type: none"> Reduce the excessive high voltage between the contacts If the load is a timer and a contactor, the release time lengthens 	Use the piezo resistance with control voltage V_c 1.5 times the supply voltage peak value. If the control voltage is excessively high, the effect of the reverse control is not good. Please check in application.
Inductance Circuit 	√	√	<ul style="list-style-type: none"> Effective when piezo resistance is connected to both contacts if the supply voltage is 24V or 48V. Effective when piezo resistance is connected to the load if the supply voltage is 100V or 200V. 	
Inductance And Resistance Circuit 	√	√	<ul style="list-style-type: none"> Reduce the excessively high voltage between the contacts 	

Notes: the mark "√" means good, the mark "X" means bad, the mark "" means notice. Please avoid using the following circuit as table 12.

Table 12

When the contacts are OFF, the effect on controlling the electric arc is good. However in this case the capacitor C stores the energy, so the energy in the capacitor C will release to the contacts, when the contacts are ON, will result in the easy welding of the contacts.	When the contacts are OFF, the effect on controlling the electric arc is good. However the contacts are easily welding due to the large charge current of the capacitor C when the contacts are ON.



HONGFA RELAY

ISO9001, ISO/TS16949, ISO14001, OHSAS18001, IECQ QC 080000 CERTIFIED

1.3.4 Precaution For mounting Protective Elements

When the protective elements such as diode, C-R, piezo resistance are mounted, they must be mounted beside the load or the contacts. If the distance is far, the protective effect will not be good. Suggest to be mounted within 50cm.

2. Precautions For The Coil

The application of rated voltage to the coil is the basis for a relay to work normally. Only applied the voltage beyond the operate voltage, the relay can work, but the rated voltage must be applied to the coil for the changes caused by the temperature and the variation of the power voltage will influence the normal operation of the relay.

2.1 Types

2.1.1 AC Operation Type (AC type)

Generally the work voltage of the relay is always a commercial frequency (50Hz or 60Hz). Suggest that the products with standard voltage specifications listed in the instructions be selected to the extent that it is possible. If the products with other specifications are required, Please contact the technicians in HONGFA company.

For AC relays, due to the factors such as eddy current loss, hysteresis loss and lower coil efficiency, the temperature rise is greater than that for DC type. When voltage exceeds $\pm 10\%$ of rated voltage, the buzz is easily produced. Please notify the variation of the power voltage.

For AC relays, when the coil breaks, there should not remain any DC voltage in the circuit; otherwise the relays can not release normally.

2.1.2 DC Operation Type (DC type)

Generally the DC relays mostly are voltage drive type. Suggest that to the extent that it is impossible, the products with the standard voltages listed in the instructions should be selected. If the products with other specifications are required, Please contact the technicians.

Please check the voltage polarities of the relay coils in the instructions. If the diode for the control or the elements for displaying are added, once the opposite connection of the voltage will lead to the abnormal operation of the relays or the abnormal operation of the added elements or even short circuit. When the coil is paralled with diode or LED, the release time will be prolonged which may reduce the electrical endurance. Please note that. In addition, for polarized relay, the polarity of the voltage applied to the coil is opposite to that in the instruction, the relay will not work.

2.2 Input Power Of The Coil

2.2.1 Input Power For AC Coil

To make the relay work reliably, please apply rated voltage to the coil. If the voltage, which does not make the relay completely operate, is continuously applied to the coil, the coil will abnormally heat to make the coil abnormal wear.

The supply voltage of AC relay would better be sine curve. The AC coil can better control the buzz. If the waveform distorts or deforms, the control function can not be displayed better. Figure 9 shows several examples of common waveforms.

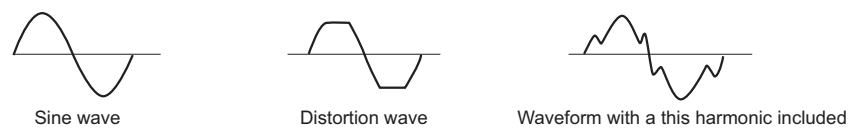

Figure 9

If the parts such as the motor, solenoid and transformer are connected in the drive circuit of the relay, when the parts work the coil voltage of the relay will reduce and then the relay contacts will shake to cause the contact welding, abnormal wear or non-conduction. The alike phenomena of the reduction of the coil voltage will happen when the miniature transformer are used, no transformer with rich capacity can be used as the power source and the wiring is long, the wiring used in the house or the shop etc. is thin. If the similar failure happens, Please use the synchro oscilloscope to check and properly adjust.

If using the loads with large variation such as the motor, Please separate the drive circuit of the coil from the power circuit according to the usage.

If the AC relay could not work reliably, switch AC to DC and then select the proper DC relay.

2.2.2 Input Power For DC Coil

In order to work steadily, the voltage applied to the two terminals of the coil of the DC relay is suggested to use



HONGFA RELAY

ISO9001, ISO/TS16949, ISO14001, OHSAS18001, IECQ QC 080000 CERTIFIED

the coil rated voltage under $\pm 5\%$ or the relay could not work steadily, to cause the contact welding or abnormal wear, especially when such parts as the motor, solenoid or transformer etc. are connected in the drive circuit of the relay, the case will be more obvious

As the power source of DC relay, there are the accumulator, the full(as shown in 10) or half wave rectifier circuit of smoothing capacitor, which will influence the operating characteristics of the relays. Please check in the practical application.

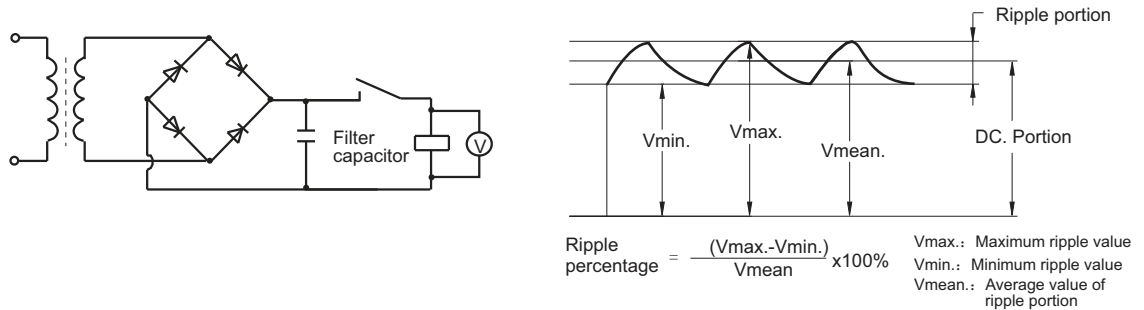

Figure 10

2.3 Maximum Voltage Of The Coil

Except for the limits from the coil temperature rise and the heat-resistant temperature of insulation material of the coil electro-magnetic wire (once beyond the heat-resistant temperature, short circuit will locally happen in the coil and even the coil burns), the maximum voltage of the coil will be influenced by heat distortion and the aging of the insulation materials. Especially it can not destroy other machines, hurt the human body or cause the fire, so it must be limited with the certain range. Therefore please do not make it beyond the regulated value in the instructions.

Maximum voltage is the maximum value of the voltage which can be applied to the coil of the relay in short time rather than the value of the voltage allowed to be continuously applied with.

2.4 The Coil Temperature Rise

2.4.1 Temperature Rise

In the course of the relay operation, the coil temperature will be increased. When a pulse voltage with ON time of less than 2 minutes is used, the coil temperature rise value is related to the ON time and the ratio of ON time to OFF time. The various relays are essentially the same in this aspect.(table 13)

Table 13

(Current Passage Time)	(%)
For Continuous Passage	Temperature Rise Value Is 100%
ON:OFF=3:1	about 80%
ON:OFF=1:1	about 50%
ON:OFF=1:3	about 35%

2.4.2 Pick-up Voltage Change Due To Coil Temperature Rise

The temperature rise causes the increase of the coil resistance and correspondently the pick-up voltage will increase. the resistance temperature coefficient of the copper wire is about 0.4% per 1°C . with this ratio, the coil resistance increases. Pick-up, release and reset voltages in the instructions are all the values in 23°C .

When the coil temperature is beyond 23°C ,pick-up voltage surpasses sometimes the speculated value in the catalogue. Please check in the practical application.

2.5 Leakage Current

When designing the circuit, please avoid the leakage current flowing through the relay when the relay does not work.



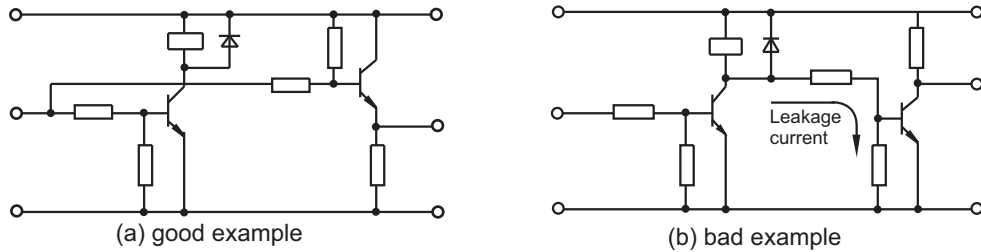

Figure 11

2.6 Energized Voltage Of The Coil And Operation Time

In the case of AC operation, there is extensive variation in operate time according to the difference of the phase when the coil is applied with the voltage.

In the case of the DC operation, although the voltage applied to the coil increases and operate time of the relay will properly become rapid, the contact bounce time when the contacts closes is extended to cause the reduction of the life or the contacts welding when they work in the rated load or in the large inrush current.

2.7 The Application Of The Relays Connected In Parallel And In Series.

Several relays connected in parallel, please take care of the wrong operation for the bypass current and leakage current shown as figure 12.

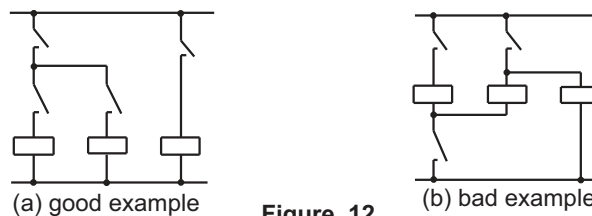

Figure 12

2.8 Avoid Gradual Increase Of Coil Impressed Voltage

In the course of the operation, the relay experiences such phases as contact pressure changing, contact bounce and the unstable condition of the contacts. When gradual increase of coil impressed voltage happens, the time of the unstable phase becomes longer to affect the life of the relay.

In order to reduce the influence on the relay, please impress bypass voltage to the coil, to the extent that it is possible.

2.9 Precaution For The Long Power Wire

If the power wire is longer, please select the relay according to the principles of impressing the rated voltage after testing the coil voltage of the relay.

If paralleled with the power line and long distance, when the supply power of the coil is switched, the voltage at the terminals of the coil will be generated due to the capacitance stored in the wire and then result in the release worse. In this case, Please connect the bypass resistor at the two ends of the coil.

2.10 Long Term Current Carrying

If the coil is continuously applied the power to for a long term, the self heating of the coil promotes the aging of the insulation materials of the coil and the worse characteristics, so in this case please use the latching relay. If the monostable relay must be used, please use the hermetic relay which is not easily influenced by the external environments and also use the suitably protective circuit to prevent the loss due to the contact failure or the break of the coil wire.

2.11 Low ON-OFF Frequency

When the ON-OFF frequency is below once per month, please periodically check the states of the contacts. If the contacts keep the non ON-OFF state for a long time, the organic film will be formed on the surface of the contacts and result in the contact failure.

2.12 Electrolytic Corrosion Of Coils

When the relays are placed in high temperature and high humidity atmospheres or with continuous passage of current, that the coil is grounded will make the coil electrolytic erosion to cause the break of the electro-magnetic wires. Therefore please do not make the coil grounded to the extent that it is possible. In the case where unavoidably the coil is grounded, please set the control switch of the relay coil in the positive side of the coil.



HONGFA RELAY

ISO9001, ISO/TS16949, ISO14001, OHSAS18001, IECQ QC 080000 CERTIFIED

2.13 Precaution For The Coil Of The Magnetic Latching Relays

2.13.1 The Coil Voltage

Please check whether the direction of coil impressed voltage is correct or not, or the relay may not work. Due to the characteristics of the magnetic latching relays, to prevent the relay against overheating and then burning, the long-term impressed voltage on the coil are not allowable.

2.13.2 Self-locking Of The Relays

Please avoid using the NC contacts of the relay itself to switch off its own coil. Otherwise the failure will happen

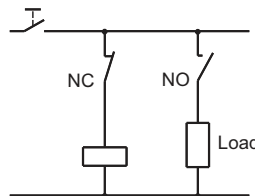

Figure 13

2.13.3 Precautions For Using The Relays Connected In Parallel

When the coil of the latching relay is connected in parallel with the coil and the solenoid of other relays, please add diode to prevent the reverse voltage from influencing the normal work of the relay.

2.13.4 Width Of Minimum Impulse In Operating And Resetting

In order to make the latching relay operate or reset, please impress the rectangle rated voltage for more than 5 times at the operate time or the reset time on the coil and then operate it. If the impulse width can not meet the requirements above, please check in the actual application.

Please avoid using in the conditions that the power source has many surges.

2.13.5 Precautions For The Double-Coil Relay

Do not impress the voltage on the set coil and reset coil at the same time, or the relay will abnormally heat, abnormally operate and even abnormally wear.

As shown in figure 14, when the terminals of either of operate coil and reset coil in the circuit are required to connect and the other terminals are connected to the same polarity of the power source, Please directly connect the terminals to connect (short circuit) and then connect to the power source. Thus the insulation between the coils can be maintained well.

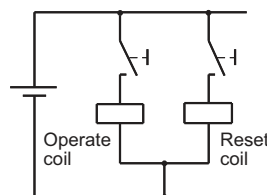

Figure 14

2.13.6 The Drive Circuit Of The Latching Single-Coil Relay

As shown in figure 15, it is one of the drive circuits of the latching single-coil relay. When the signals are input, the current charges the capacitance C and in turn charges the coil and then make the relay operate; when the signals are removed, the electric power stored in the capacitance C will discharge through trinode Tr and the coil and make the relay reset.

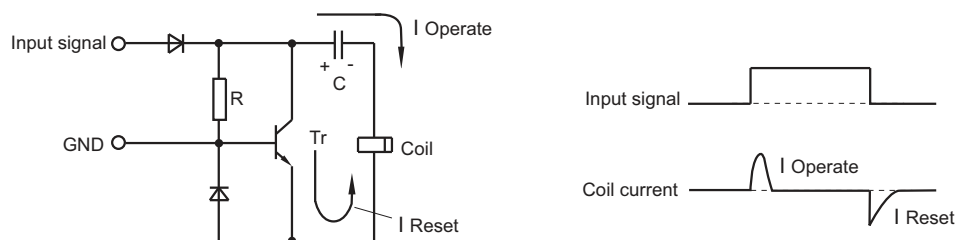

Figure 15



3. Performance

3.1 Precautions For Plastic Sealed Relays

Hermetic relays can resist under bad surrounding. However, please pay attention to the following precautions in application to avoid the failure.

3.1.1. Regarding Practical Environment

Plastic sealed relays are not suitable for using in the environment which has the special requirement for the air seal. Please avoid using them in the pressure exceeding 86kPa to 106kPa.

3.1.2. Regarding washing

When washing PC board after the terminals soldered on PC board, suggest that the washing can be done by washing solvent of alcohol series.

Please avoid supersonic washing for supersonic washing may cause the break of the coil wire and the light contact welding.

3.2 Vibration And Shock

The transient break of the contacts when the relays are shocked strongly, will lead to the false operation. Therefore, when the relays are mounted on the same board with other parts (such as electromagnetic switch, air switch et.) which can produce the shock, the measures of reducing the influence of the shock on the relay should be taken. For example, make the direction of the shock and direction of relay contacts make/break at the right angles to the moving direction of armature, or to mount these components on different boards, or using a buffer tablet, or to take some measures in the application circuit to reduce the impact of false operation of relay contacts (as illustrated by figure 16):

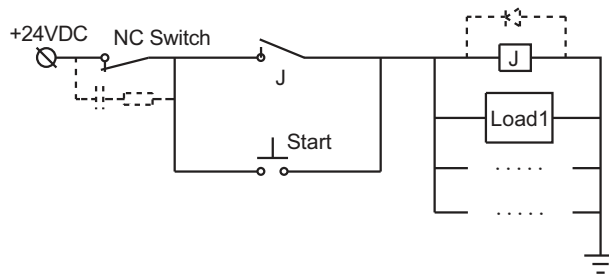

Figure 16

Remarks: in the above figure, a RC is parallel connected to NC switch, and a FWD is parallel connected to relay coil. This measure can avoid the abnormal cut-off of the circuit caused by the abrupt break of NC switch under strong shock and vibration.

In addition, for the relay in the vibration atmosphere in the long term (such as electrical car), please avoid combining with the socket in application. Suggest that the relay be directly soldered on the PC board.

3.3 The Influence Of External Magnetic Fields

If there is the strong magnetic fields around the relay, if the relay is mounted beside the large relay, transformer or the speaker, the characteristics will produce the false operation with the variation of the external magnetic fields, especially for polarized relays. Because the operation of the relay is dependent on the internal permanent magnet, it is easily influenced by the external magnetic fields. Please pay attention to the mounting position in practical application and check.

3.4 Vibration, Shock And Weight During Shipping

During shipping the relay or the equipment with the relay installed, the large vibration, shock and weight will cause the failure of the relay functions. Please use the cushion package to control the vibration and shock within the allowable range.



HONGFA RELAY

ISO9001, ISO/TS16949, ISO14001, OHSAS18001, IECQ QC 080000 CERTIFIED

4. Environments

4.1 Regarding Ambient Temperature And Atmosphere

Care is taken that the ambient temperature at the installation does not exceed the value listed in the instructions. In addition, the contact surface will form sulfured film, oxide film or attached dust in an atmosphere with dust, moisture and sulfur gases (SO₂, H₂S etc.) or organic gases to cause the unstable contact and the failure of the contacts. Therefore please select sealed relays. If the plastic sealed relay is selected, it is required to check in application.

4.2 The Harmful Gases To The Relay

Please do not use the relay in the atmosphere with the following gases. In these atmospheres, plastic sealed relays can not avoid the influence of gases on the contacts. Please use the hermetic relays.

4.2.1 Silicon Atmosphere

Silicon-based substances (silicon rubber, silicon oil, silicon-based coating material and silicon caulking compound etc.) around the relay will emit volatile silicon gas, which may cause the silicon to adhere to the contacts and may result in contact failure.

4.2.2 Sulfureted Gas

Sulfured gases easily sulfur the contacts and result in the contact failure or non-conduction.

4.2.3 NO_x Gas

When a relay is used in an atmosphere high in humidity to switch a load which easily produces an arc, the NO_x created by the arc and the water absorbed from outside the relay combine to produce nitric acid. This corrodes the internal metal parts and adversely affects operation. Please do not use the relay in the atmosphere where the humidity is beyond 85%RH (at 20°C).

4.3 The Circumstance With Water, Leechdom, Solvent And Oil

Do not use and store the relays in the atmosphere where the relays may be attached to by water, leechdom, solvent and oil etc. for water and leechdom may make the parts rusted, the plastics aging and also result in leakage current which damages the relays or the circuit and solvent and oil may make the marks disappearing or the parts aging. For covers made from PC materials, please prevent from contamination by some organic solvents; otherwise it is likely to lead to bulging or crack.

4.4 Atmosphere Of Usage, Storage And Transport

During usage, storage and transportation, avoid locations subject to direct sunlight and maintain normal temperature, humidity and pressure conditions. The allowable range of the temperature and humidity suitable for usage, storage and transportation are shown in the unshaded part in figure 17. The allowable temperature may differ with the types of the relays. In case that the condition in real application is different from that of IEC 61810-1, UL508, UL60947-4-1, GB/T21711.1, etc. the electrical endurance of the relay must be confirmed by tests.

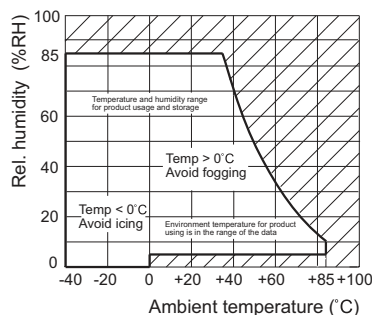

Figure 17

The suggested ranges of the temperature and humidity during usage, transportation and storage are as follows.

- 1) temperature: 0°C to 40°C
- 2) humidity: 5%RH to 85%RH
- 3) air pressure: 86kPa to 106kPa.



HONGFA RELAY

ISO9001, ISO/TS16949, ISO14001, OHSAS18001, IECQ QC 080000 CERTIFIED

4.4.1 The Atmosphere High In Humidity

In the atmosphere high in humidity, when the temperature around sharply changes, the dew will be formed in the internal of the relay and result in the cracking of the insulation material, the break of the coil wire and the rust. The typical examples will happen on the ship transporting on the sea.

Dewing is a phenomena that the vapor freezes water drops in the atmosphere high in temperature when the temperature sharply reduces from the high temperature to the low temperature or the relay is moved in the high temperature from the low temperature

4.4.2 Low Temperature (under 0°C) Environment

Please note the icing phenomena in the environment with low temperature (under 0°C). Icing may result in the welding of the movable parts, the delay of the operation or preventing the operation etc.

Icing refer to the phenomena that water attached to the relay will freeze ice when the temperature reducing below freezing point.

4.4.3 Low Temperature , Low Humidity Environment

Note that the plastics may embrittle in low temperature, low humidity environment.

4.4.4 High Temperature, High Humidity Environment

Note that if the relay is in high temperature, high humidity environment for a long time the contact surface easily forms the oxidized film and then results in the unstable contact and the failure of the contacts. Other metal parts also are easily oxidized or rusted to result in the failure of the functions

4.4.5 SMT Environment

The relay of SMT type is sensitive to the humidity so they are packed with humidity proof package. The following points should be considered during storage.

1) Please use the humidity proof packing bags as soon as possible after they are unsealed.

2) If the humidity proof packing bags need long term storage after they are unsealed, it is suggested that the desiccator with humidity control be used to store them.

5. Outline And Mounting

5.1 Top View And Bottom View

Generally the bottom view is the projection whose projection plane is terminal side. Otherwise, the top view is the projection whose projection plane is cover side. Please take care of it when using the instructions or mounting the relays.

5.2 Mounting Direction

Unless otherwise stated, mounting direction of the relays is arbitrary. In order that the relay can work more stable and reliable, mounting direction need cosidering.

5.2.1 Vibration Resistance And Shock Resistance

It is ideal to mount the relay so that the movement of the contacts and movable parts is perpendicular to the direction of vibration or shock. Especially when the coil is not excited, the vibration or shock resistance of NC contacts is weak. If mounting direction is proper, their functions can be ensured.(figure 18)

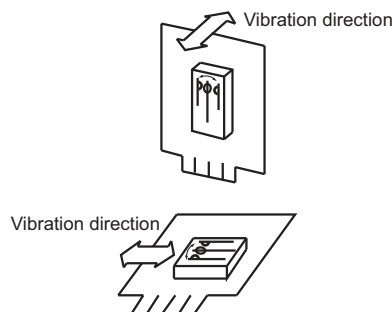

Figure 18



HONGFA RELAY

ISO9001, ISO/TS16949, ISO14001, OHSAS18001, IECQ QC 080000 CERTIFIED

5.2.2 Contact Reliability

Mounting the relay so the surfaces of its contacts are vertical prevents dirt and dust as well as scattered contact material and powdered metal from adhering to them when the arc is generated.

5.3 Adjacent Mounting

When many relays are mounted close together, abnormally high temperatures may result from the combined heat generated. To prevent the heat buildup, please mount relays with sufficient spacing between them. When many boards mounted with relays are installed in a card rack, please be sure that the ambient temperature of the relay does not exceed the value listed in the instructions.

5.4 Shroud Mounting

Use the gaskets when mounting to prevent from the damages and deforms. Keep the screwing moment in the range of 0.49 to 0.686N · m (5 to 7kgf·cm. To prevent from loosening, please use the spring gasket.

5.5 Mounting The Plug-In Terminals

When mounting the relay with plug-in terminals, the plug-in strength is based on 40N to 70N (4kgf to 7kgf).

5.6 Supersonic Cleaning

Do not clean the relay by the way supersonic cleaning, for the supersonic will result in the contact welding and the break of the coil wire.

5.7 Mounting And Soldering Of THT Relays

The mounting and soldering of the THT relay can be divided into the following steps.(figure 19)

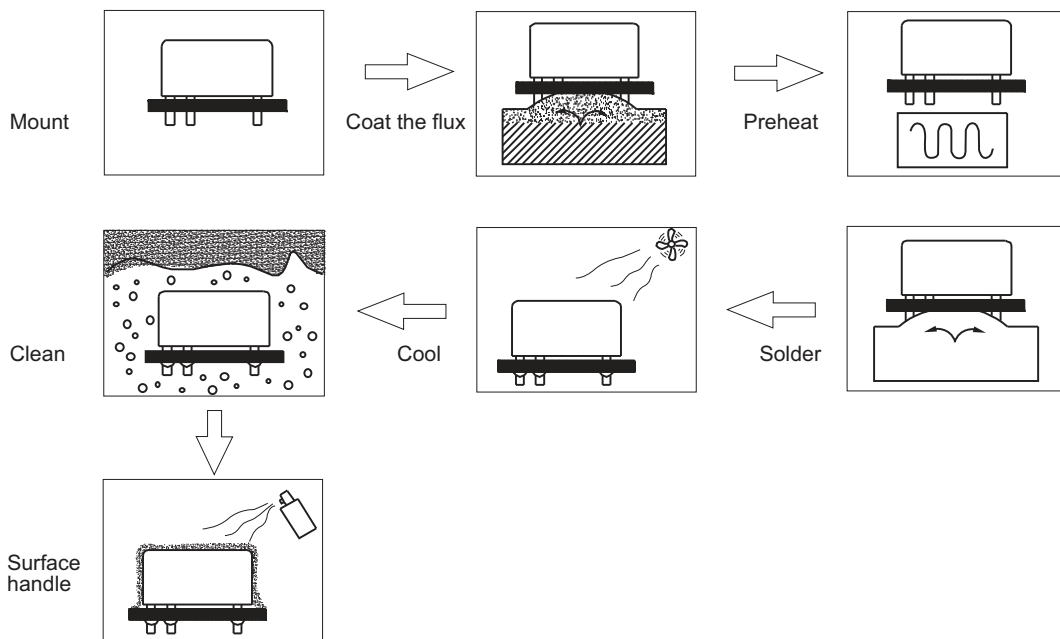

Figure 19

In the following the considered points are described when THT relay is soldered on the PC board. Please refer to them in application.

Note that if the solder entered the relay due to the carelessness, the functions of relay will be destroyed. There will be such problems as the relay not be suitable for the automatic soldering or cleaning due to the different protective constructions. Please see the details in the constructions and characteristics in 3.1 pattern of encapsulation in Chapter 2.



HONGFA RELAY

ISO9001, ISO/TS16949, ISO14001, OHSAS18001, IECQ QC 080000 CERTIFIED

5.7.1 Mounting

Do not bend the terminals of the relay (figure 20) for it may destroy the initial performances of the relay. Please correctly process the PC board according to the mounting hole drawing in the instructions. Please maintain the balance of the relay. Please note that the set force of the hook for mounting is too much large to result in the internal failure of the relay.

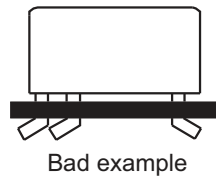

Figure 20

5.7.2 Coating Flux

Please use the rosin flux which is not corrosive and the alcohol solvent which is less chemistry. Please use the thin and even coating flux to prevent from penetrating the relay. As for the dipping coating, please keep the surface of the flux stable. Please adjust the places to ensure that the flux will not overflow through the surface of PCB. Please do not make the flux attached to the parts of the relay except for the terminals. Otherwise the insulation of the relays will be reduced. For the dust protected relays and flux proofed relays, do not use the coating method of pushing deeply PCB from the above into the sponge absorbing the flux, as shown in figure 21. This will make the flux penetrating the relay, especially for the dust protective type.

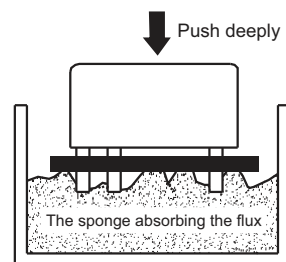

Figure 21

5.7.3 Preheating

In order to improve the soldering performance, please preheat without failure. Please preheat under 100°C (the soldered surface of the PC board) within 1 minute. Do not use the relays which are placed in the high temperature for a long time due to the set failure for their initial performance may have changed.

5.7.4 Soldering

Precautions for soldering seen in table 14.

Table 14

Automatic Soldering	Manual Soldering
<ul style="list-style-type: none"> To maintain the soldering stable, the suggested soldering method is wave solder. Adjust the height of flux liquid level to make them not overflow the PCB. Please do it according to following suggested conditions. Soldering temperature: about 260°C ± 5°C (Applicable to Power relays) Soldering temperature: about 250°C ± 5°C (Applicable to Signal relays) Soldering time: within about 5s. 	<ul style="list-style-type: none"> Please sufficiently clean the head of searing-iron with fluxing to make the surface of it smooth. Please do it according to the following suggested conditions. Searing-iron: 30W or 60W The temperature of the head of searing-iron: about 280°C or 300°C Soldering time: within about 3s Use the solder with rosin fluxing.



Remarks: 1. The preheating and soldering temperature and time for automatic soldering should be reduced as low as possible to avoid any change in relay performance due to excessively high temperature or too long time preheating or soldering.

2. It is normal if some relay covers become slightly bulging under right soldering conditions.

3. In the process of manual soldering it is prohibited to press or pull the relay terminals because such doing will lead to changes in product performance or even relay failures.

5.7.5 Cooling

After automatic soldering, please ventilate and cool them to avoid the aging of the relay or its parts caused by the heat generated when the relay soldered.

Although the sealed relay can be cleaned, it is not cleaned for the sudden connection with the cool solvent may damage the hermetic characteristics of the relay.

5.7.6 Cleaning

Please select the cleaning method in table 15 when cleaning.

Table 15

Dust Protected Type	Flux Proofed Type	Plastic Sealed Type
<ul style="list-style-type: none"> ● Hot cleaning or soap cleaning not allowable ● Scrub the welding surface of PCB 		<ul style="list-style-type: none"> ● Washable in limited condition. ● Use the alcohol solvent or water. ● The temperature for cleaning is under 40°C. ● Do not do supersonic cleaning or truncate the terminals of the relays, or the break of the coil wire and the contact welding will happen.

Due to different soldering condition, sealed relays can be impaired when mounting on PCB. If cleaning is necessary after soldering, it is recommended to solder under the condition provided by HF and to select special sealed relays (customer code: 310).

Avoid cleaning with Freon, Trichloroethane, diluent or gasoline.

5.7.7 Surface Handling

In order to prevent the insulation of PCB from worsening, Please note the following precautions when surface handling.

The dust protected type and the flux proofed type result in the failure due to the surface handling agents penetrating the relay. Therefore please do not do the surface handling or mount the relay after surface handling.

Due to the bad influence of the surface handling agents on the relay eg. melting the cover, please select carefully and check and test in application.

Spraying and brushing processes are recommended for surface treatment, and dip-coating is prohibited. Surface treatment agent should best be room-temperature liquid agent, which should be sprayed when the relay is cooled down to room-temperature. The agent can be dried naturally or under constant temperature which should not exceed 60°C. Meanwhile, the drying temperature is not allowed to be decreased when the agent is not completely dried, otherwise the agent could be absorbed into the relay and thus lead to relay failure.

Please contact us when special surface treatments processes are used so that we can provide you a suitable product.

There are the following suggestions on the coat, as shown in table 16.

Table 16

Type Of The Coat	Plastic Sealed Relay
Epoxy resin	Allowable
Polyurethane	Allowable
Silicon	Not allowable
Fluorin	Allowable



HONGFA RELAY

ISO9001, ISO/TS16949, ISO14001, OHSAS18001, IECQ QC 080000 CERTIFIED

5.8 Mounting And Soldering Of SMT Relays.

The mounting and soldering of SMT relays have the following steps, as shown in figure 22. In the following the considered points are listed when the SMT relays are soldered on PCB.

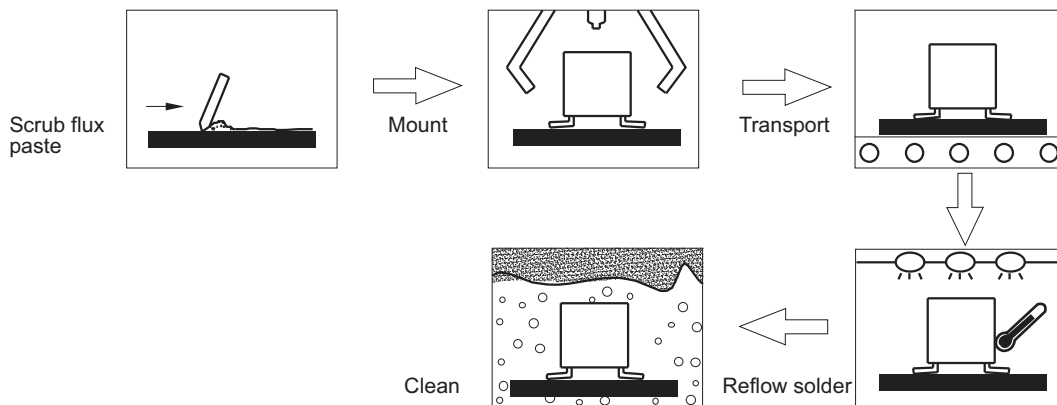

Figure 22

Please refer to these in application. Note that the relays are not damaged in processing.

5.8.1 Scrub Flux Paste

Please use the rosin and chlorine-free flux paste for chlorine may erode the terminals and circuit panel. Flux paste should be coated evenly and the thickness is 0.15mm or 0.2mm.

5.8.2 Mounting

When mounting the relays, do not set the conservative force of the finger within the range specified in table 17, unless otherwise stated in the catalogue.

Direction	Maintaining Force	
Birection A	Below 1.96N	
Birection B	Below 4.9N	
Birection C	Below 1.96N	

5.8.3 Transportation

During the transport, the relays will not fall off due to the factors such as the shock and vibration to avoid the bad soldering produced thereby.

5.8.4 Reflow Solder

Figure 23 shows the temperature curve of the PCB surface when the infrared ray are used to reflow solder. Please consult the specification of the relays due to the different characteristics of the different relays. If there is no statement in the instructions, Please use the temperature curve as shown in the following figure.

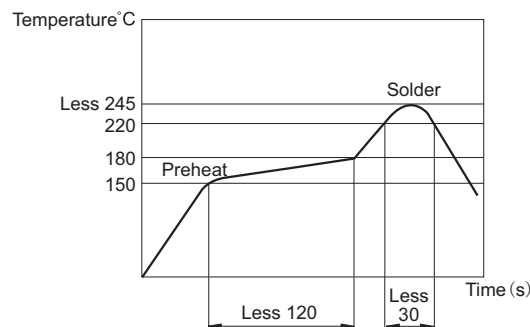

Figure 23



When just finishing soldering, please do not clean the relay immediately, for the connection with the cool solvent may damage the hermetic characteristics of the internal parts.
Do not dip the relay in the flux groove for it will deform the plastics and then result in the failure of the relays.
Please see the soldered state in figure 24.

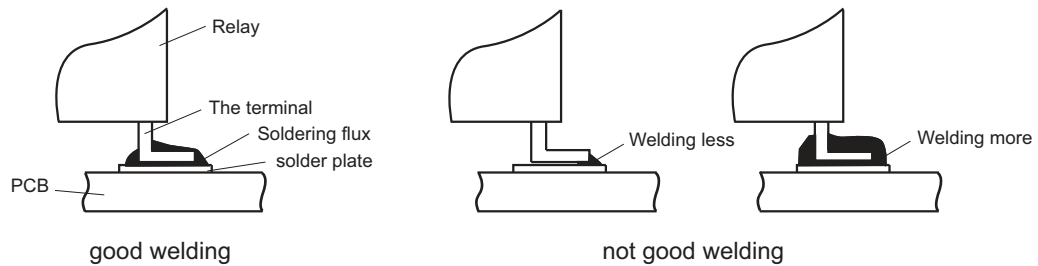

Figure 24

5.8.5 Cleaning

Hot cleaning or soap cleaning can be used and the cleaning temperature should be controlled under 40°C.
Please use the alcohol solvent or water to clean and do not use Freon, thinner or gasoline to clean.
Do not use supersonic to clean, or the break of the coil wire and the contact welding will be resulted in.
Improper welding will decrease the relay sealing, so please do not clean the relay or do the surface treating (soaking prtector).

6. Other Precautions

6.1 Precautions For The Safety

When the relay works, do not touch the relay with hands for there is the danger of getting the electric shock.
Please switch off the power when mounting, maintaining and handling the relays (including the connecting parts such as terminals and sockets).
When connecting the terminals, firstly refer to the wiring diagram in the instructions, and then make correct connection. The false connection may result in the unexpected false operation, abnormal heating or fire.
If the contact welding, the failure of the contact or the break of the coil wire happens, other properties or lives will be threatened. Please use the double mounting sets.

6.2 Tube Packaging

When packing the relay by the tube, do not shake the tube to shock the relays, for which will result in the failure of the relays. If the package uses the stop plug, be sure to slide the stopper plug to hold the remaining relays firmly together so they would not move in the tube.

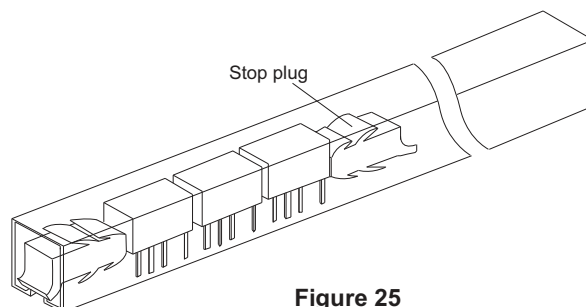

Figure 25



HONGFA RELAY

ISO9001, ISO/TS16949, ISO14001, OHSAS18001, IECQ QC 080000 CERTIFIED

CHAPTER 4 QUICK ZOOM TABLE FOR REASONS FOR FAILURE

Some common failure phenomena, failure modes, and the reasons. See table 18:

Table 18

Failure Phenomena	Failure Mode	Failure Reason
Non-operation	No current at the terminals of the coil	<ul style="list-style-type: none"> ● Breaking circuit ● Worse connected or short circuit ● Terminal welded worse
	Insufficient voltage in the circuit	<ul style="list-style-type: none"> ● Insufficient voltage supply ● Power circuit too long ● the voltage of the chosen relay too high
	Circuit unconnected	<ul style="list-style-type: none"> ● Welded worse ● Coil breaking
	Relay failure	<ul style="list-style-type: none"> ● Drop, bumped badly ● Contact failure
	Voltage polarity of the polarized relay is wrong	<ul style="list-style-type: none"> ● Bumped during the transportation ● circuit connected badly
No Release	Surplus voltage too high	<ul style="list-style-type: none"> ● Energy storage component's influence ● Leakage current or bypass current ● Surplus voltage of the semiconductor too high
	Relay failure	<ul style="list-style-type: none"> ● Drop, bumped badly ● contact failure
Unsteady Operation	Unsteady power	<ul style="list-style-type: none"> ● PARD(periodic and random deviation) ● Insufficient voltage ● Resistor beyond the tolerance
	Unsteady parameter	<ul style="list-style-type: none"> ● Drop or bumped badly ● Short form among the coils
	False operation of the relay	<ul style="list-style-type: none"> ● Something wrong with the control procedure ● The vibration excessively strong in application
NC/NO Contact Welding	Current excessively high	<ul style="list-style-type: none"> ● Load excessively high ● Surge current too high
	Contact Moving abnormally	<ul style="list-style-type: none"> ● External vibration excessively strong ● AC relay's unstable operation; with buzz ● Unstable operation
NC/NO Contact Welding	Operation frequency excessively high	
	Ambient temperature excessively high	
	Use beyond the life	
NC/NO Contact Not Closed	Contact resistance too high	<ul style="list-style-type: none"> ● Weld worse ● Contamination in the contact ● Bad using environment, contact oxidizing or sulphidizing
	No current in the contacts surface	<ul style="list-style-type: none"> ● Load circuit break ● Circuit connected worse or short circuit ● Terminal welded worse
	Use beyond the life	

Notes: when failure happens, if there's any question, please contact us.



HONGFA RELAY

ISO9001, ISO/TS16949, ISO14001, OHSAS18001, IECQ QC 080000 CERTIFIED

CHAPTER 5 ORDERING EXAMPLE

Ordering code contains the basic information of the relays. Table 19 is an ordering example of a typical Hongfa product. Please refer to the datasheet of each product for part no. selection.

	HF161F /	12	-H	T	Table 19 (XXX)
Type					
Coil voltage	5, 12, 24, 48VDC				
Contact arrangement	H: 1 Form A				
Contact material	T: AgSnO ₂		Nil: AgCdO		
Special code¹⁾	XXX: Customer special requirement		Nil: Standard		

Notes: 1) The customer special requirement express as special code after evaluating by Hongfa. e.g. (414) stands for product with coil terminal of 1.4X0.4.





Xiamen Hongfa Electroacoustic Co.,Ltd.

ADD.: No.91-101, Sunban S.Rd., Jimei North Ind. Dist., Xiamen, China

TEL.: + 86 - 592 - 6106688 **Fax:** + 86 - 592 - 6106678

Marketing & Sales Network

Head Quarter's Marketing & Sales Center

ADD: No.560-578, Donglin Rd., Jimei North Ind. Dist., Xiamen, China

TEL: 400-600-1502 **FAX:** +86-592-6686063

E-mail: marketing@hongfa.com

Hongfa America, INC.

ADD: 20381 Hermana Circle, Lake Forest, CA92630, USA

TEL: +1-714-669-2888

E-mail: sales@hongfaamerica.com

Hongfa Europe GmbH

ADD: Marie-Curie-Ring 26, D-63477 Maintal, Germany

TEL: +49-6181-4306-0

E-mail: info@hongfa-europe.com

Hongfa Italy Srl

ADD: C/O Regus Business Center, Via Senigallia 18/2 Torre A, 20161 Milan, Italy

TEL: +39-02-64672-325

E-mail: marco.fuccillo@hongfa-europe.com

Hongfa Electroacoustic

(Hongkong) Co.,Ltd

ADD: Rm 1810-12, 18/F., Shatin Galleria, 18-24 Shan Mei St., Fotan, N.T, HongKong

TEL: +852-2947-7889

E-mail: hongkong@hongfa.com

Shanghai Hongfa

Electroacoustic Co., Ltd.

ADD: NO.51.341, Jiuting Rd., Jiuting Town, Songjiang Dist., Shanghai

TEL: +86-21-37693111

E-mail: shanghai@hongfa.com

Beijing Hongfa

Electroacoustic Relay Co., Ltd.

ADD: 111Bldg, Phase IV Westside of Lian-dong U Valley, Tongzhou Dist., Beijing

TEL: +86-10-56495556

E-mail: beijing@hongfa.com

Sichuan Hongfa Relay Co., Ltd.

ADD: 1 Bldg, 3Unit, 1002-1004 Room, Jingtianguoji, No.288, Taisheng S.Rd., Qingyang Dist., Chengdu

TEL: +86-28-86627550

E-mail: sichuan@hongfa.com

Hongfa India Branch

ADD: #1001 Archana Mansion, 3rd Main, B.S.K 3rd Stage, Hoskerekhalli, Bangalore-560 085, India

TEL: +91-80-26422678/+91-88453 47993

E-mail: amarnath@hongfa.com

Hongfa Taiwan Branch

TEL: +886-2-22428621, 975192582

E-mail: taiwan@hongfa.com

Hongfa Korea Branch

TEL: +82-10-5355-4899 / +82-10-8704-4706

E-mail: korea@hongfa.com / khlee@hongfa.com

Hongfa Brazil Branch

TEL: +55-11-949697906

E-mail: mauro-loyola@hongfa.com

Hongfa Philippine Branch

TEL: +639177189352 / +639175780846

E-mail: nia-videna@hongfa.com

Hongfa Turkey Branch

TEL: +90-535-0221881

E-mail: info-turkey@hongfa.com



Scan here for more information.