

# HENGPENG

HENGPENG INTERNATIONAL



## PRODUCTS AND APPLICATIONS



# LCH CONNECTORS

## FAST AND INTUITIVE CONNECTORS

**NEW**

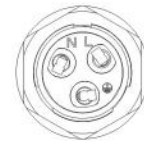

LCH1710.68FC  
LCH1710.68FCS



LCH1710.68FC-5P

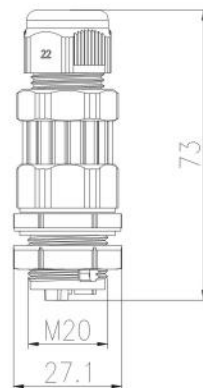

LCH1610.68FC  
LCH1610.68FCS



LCH1610.68FC-5P

### Test standard:

IEC61984:2009  
IEC62444:2013  
IEC60529:1991+A1:2000+A2:2013

### Technical information:

250V/450V, PTI 250, T85, IP68 at 5 bar  
16A

### Material Specification:

Housing: PA 66, UL94-V0  
Sealing gasket: Silicon  
Contact: Copper, Silver plated.  
Color: Black or Gray

### Mechanical Specification:

Termination:  
LCH1610.68FC / LCH1610.68FC-5P/LCH1710.68FC /  
LCH1710.68FC-5P: FAST CONNECT  
LCH1610.68FCS / LCH1710.68FCS:  
FAST CONNECT+Screw fixing  
Wiring cable spec:  
Φ 5mm Min; Φ 12mm Max. LCH1610.68 SERIES  
Φ 5mm Min, Φ 12.8mm Max. LCH1710.68 SERIES

Warranty 3 years limited



# LCH CONNECTORS

## IN-LINE CIRCULAR JOINT-CONNECTORS



M25

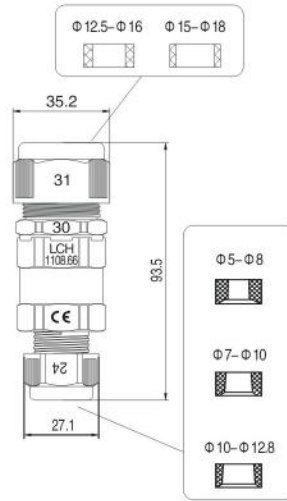

LCH1108.66-I-3P-M25

M25

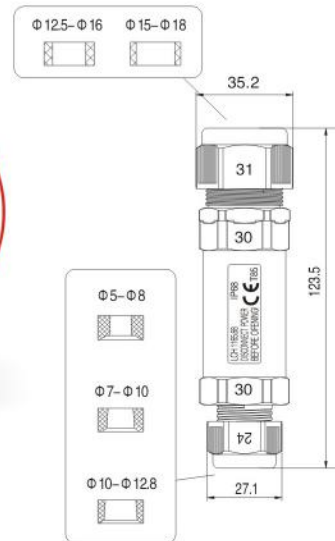

LCH1165.68-I-3P-M25



LCH1165.68-I-3PA-M25



LCH1165.68-I-5P-M25

### Test standard:

IEC60998-2-1:2004

IEC62444:2013

IEC60529:1991+A1:2000+A2:2013

### Technical information:

250V/450V, PTI 250, T85, IP 68 at 5 bar  
24A

### Material Specification:

Housing: PA 66, UL94-V0

Sealing gasket: Silicon

Contact: Copper, nickel plated.

Color: Black

### Mechanical Specification:

Termination: Screw fixing

Wiring cable spec:











$\Phi 12.5$ mm Min;  $\Phi 18$ mm Max; M25 SIDE

$\Phi 5$ mm Min,  $\Phi 12.8$ mm Max; OTHER SIDE

Warranty 3 years limited



# INDEX

	<b>IN-LINE CIRCULAR JOINT-CONNECTORS</b>	<b>01</b>
	<b>T-JUNCTION CIRCULAR JOINT-CONNECTORS</b>	<b>03</b>
	<b>JUNCTION BOXES WITH TERMINAL BLOCKS</b>	<b>04</b>
	<b>PLUG - SOCKET CONNECTORS</b>	<b>05</b>
	<b>FAST AND INTUITIVE CONNECTORS</b>	<b>06</b>
	<b>JUNCTION JAR</b>	<b>10</b>
	<b>IP20 JUNCTION BOXES</b>	<b>11</b>
	<b>GR GROMMETS</b>	<b>12</b>
	<b>DOWNLIGHT</b>	<b>13</b>
	<b>TRI-PROOF LIGHT</b>	<b>16</b>

# LCH CONNECTORS

## IN-LINE CIRCULAR JOINT-CONNECTORS

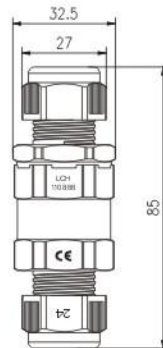

LCH1108.66-I-3P

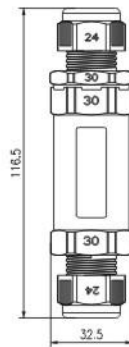

LCH1165.68-I-3P



LCH1165.68-I-3PA



LCH1165.68-I-5P

### Test standard:

IEC60998-2-1:2004

IEC62444:2013

IEC60529:1991+A1:2000+A2:2013

### Technical information:

250V/450V, PT1 250, T85, IP 68 at 5 bar  
24A

### Material Specification:

Housing: PA 66, UL94-V0

Sealing gasket: Silicon

Contact: Copper, nickel plated.

Color: Black

### Mechanical Specification:

Termination: Screw fixing

Wiring cable spec:

Φ 5mm Min; Φ 14mm Max.

**Warranty 3 years limited**



# LCH CONNECTORS

## IN-LINE CIRCULAR JOINT-CONNECTORS

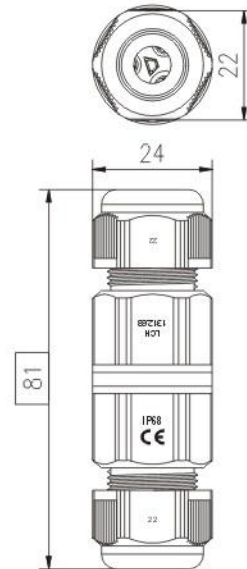

LCH1312.68-3P



LCH1312.68-4P

### Test standard:

IEC60998-2-1:2004

IEC62444:2013

IEC60529:1991+A1:2000+A2:2013

### Technical information:

250V/450V, PTI 250, T85, IP 68 at 5 bar  
16A

### Material Specification:

Housing: PA 66, UL94-V0

Sealing gasket: Silicon

Contact: Copper, nickel plated.

Color: Black

### Mechanical Specification:

Termination: Screw fixing

Wiring cable spec:

Φ 5mm Min; Φ 12mm Max.

**Warranty 3 years limited**



# LCH CONNECTORS

## T-JUNCTION CIRCULAR JOINT-CONNECTORS

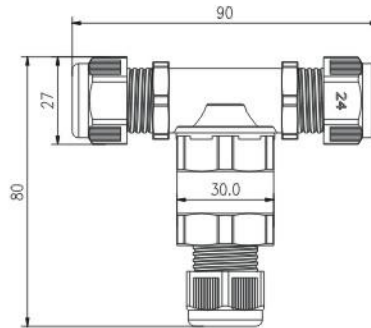

**Test standard:**  
 IEC60998-2-1:2004  
 IEC62444:2013  
 IEC60529:1991+A1:2000+A2:2013

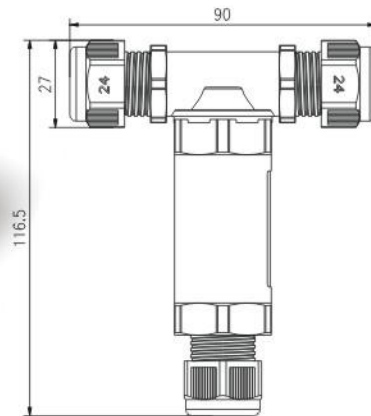

**Technical information:**  
 250V/450V, PTI 250, T85, IP 68 at 5 bar  
 24A

**Material Specification:**  
 Housing: PA 66, UL94-V0  
 Sealing gasket: Silicon  
 Contact: Copper, nickel plated.  
 Color: Black



**Mechanical Specification:**  
 Termination: Screw fixing  
 Wiring cable spec:  
 $\Phi$  5mm Min;  $\Phi$  14mm Max.

**Warranty 3 years limited**



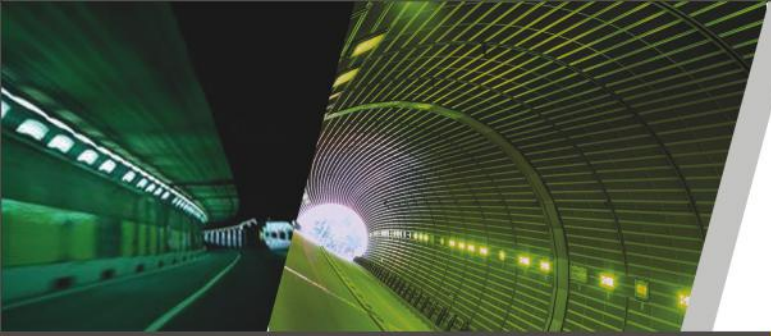

# LCH CONNECTORS

JUNCTION BOXES WITH TERMINAL BLOCKS

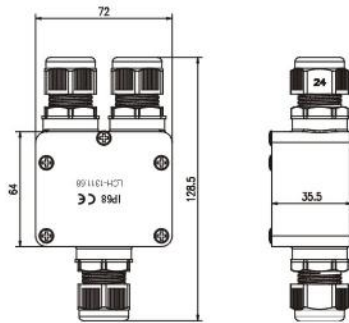

LCH1311.68-3PB



LCH1311.68-5PB



LCH1311.68-3P



LCH1311.68-5P



### Technical information:

250V/450V, PTI 250, T50, IP 68  
16A

### Test standard:

IEC60998-2-1:2004  
IEC62444:2013  
IEC60529:1991+A1:2000+A2:2013

### Material Specification:

Housing: PC  
Sealing gasket: Silicon  
Contact: Copper, nickel plated.  
Color: Transparent

**Warranty 3 years limited**

### Mechanical Specification:

Junction: 3 or 5 pole terminal block  
Wiring cable spec:  
Φ5mm Min; Φ14mm Max.





# LCH CONNECTORS

## PLUG - SOCKET CONNECTORS



### Test standard:

IEC61984:2009  
 IEC62444:2013  
 IEC60529:1991+A1:2000+A2:2013

Warranty 3 years limited

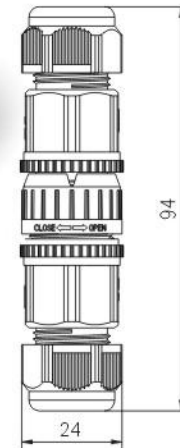

### Technical information:

250V/450V, PTI 250, T85, IP 68 at 5 bar  
 16A

### Material Specification:

Housing: PA 66, UL94-V0  
 Sealing gasket: Silicon  
 Contact: Copper, Silver plated.  
 Color: Black

### Mechanical Specification:

Termination: Screw fixing  
 Wiring cable spec:  
 Ø 5mm Min; Ø 12mm Max.



LCH 1312.68C-3P

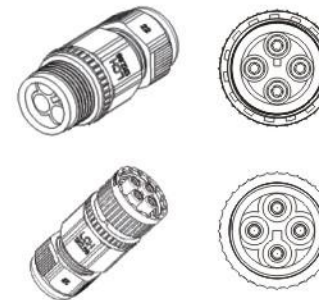

LCH 1312.68C-4P



LCH 1312.68C-5P



# LCH CONNECTORS

## FAST AND INTUITIVE CONNECTORS

- Fast and intuitive connecting system
- ➔ COST - SAVINGS INSTALLATION

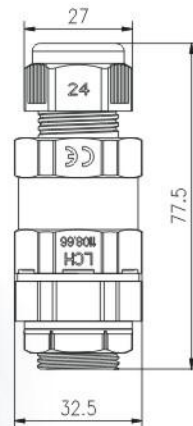

LCH1108.66FC

### Test standard:

IEC61984:2009  
IEC62444:2013  
IEC60529:1991+A1:2000+A2:2013

### Technical information:

250V/450V, PTI 250, T85, IP 68 at 5 bar  
6A

### Material Specification:

Housing: PA 66, UL94-V0  
Sealing gasket: Silicon  
Contact: Copper, Silver plated.  
Color: Black or Gray

### Mechanical Specification:

Termination: Ideal fast connect  
Wiring cable spec:  
Φ 5mm Min; Φ 12mm Max.

Warranty 3 years limited



# LCH CONNECTORS

## FAST AND INTUITIVE CONNECTORS



- Fast and intuitive connecting system
- ➔ COST - SAVINGS INSTALLATION



LCH1610.68FC / LCH1610.68FCS

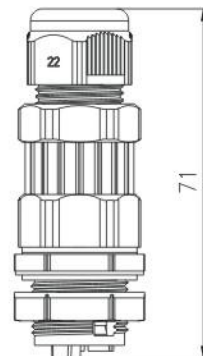
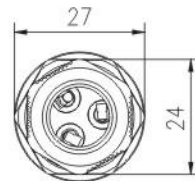

-07-

### Test standard:

IEC61984:2009

IEC62444:2013

IEC60529:1991+A1:2000+A2:2013

### Technical information:

250V/450V, PTI 250, T85, IP 68 at 5 bar  
16A

### Material Specification:

Housing: PA 66, UL94-V0

Sealing gasket: Silicon

Contact: Copper, Silver plated.

Color: Black or Gray

### Mechanical Specification:

Termination:

LCH1610.68FC: FAST CONNECT

LCH1610.68FCS: FAST CONNECT+Screw fixing

Wiring cable spec:

Φ5mm Min; Φ12mm Max.

Warranty 3 years limited





# LCH CONNECTORS

FAST AND INTUITIVE CONNECTORS



LCH1610.68FC/LCH1610.68FCS



LCH1108.66FC

- Replace the use of cable gland
- Avoid cable management
- Prevent direct access inside the equipments
- Allow a quick and reliable wiring by the installer
- Allow safe and rapid maintenance activity

# LCH CONNECTORS

## FAST AND INTUITIVE CONNECTORS



**NEW**

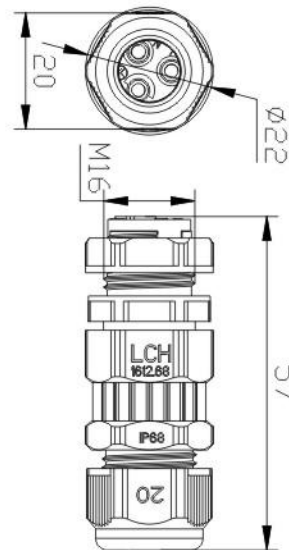

LCH1612.68FCS

-09-

### Test standard:

IEC61984:2009

IEC62444:2013

IEC60529:1991+A1:2000+A2:2013

### Technical information:

250V/450V, PTI 250, T85, IP 68 at 5 bar  
16A

### Material Specification:

Housing: PA 66, UL94-V0

Sealing gasket: Silicon

Contact: Copper, Silver plated.

Color: Black or Gray

### Mechanical Specification:

Termination: Screw fixing

Wiring cable spec:

Φ 5mm Min; Φ 10mm Max.

**Warranty 3 years limited**



# LCH CONNECTORS

## JUNCTION JAR



### Test standard:

IEC 60670-1:2002, AMD 1:2011  
IEC 60529:1991+A1:2000+A2:2013

### Technical information:

1kv, T85, IP 68

### Material Specification:

Housing: PP, UL94-V0  
Sealing gasket: Silicon  
Color: Black or Red

### Mechanical Specification:

Wiring cable spec:  
 $\Phi$  5mm Min;  $\Phi$  16mm Max.

**Warranty 3 years limited**



LCH1611.68

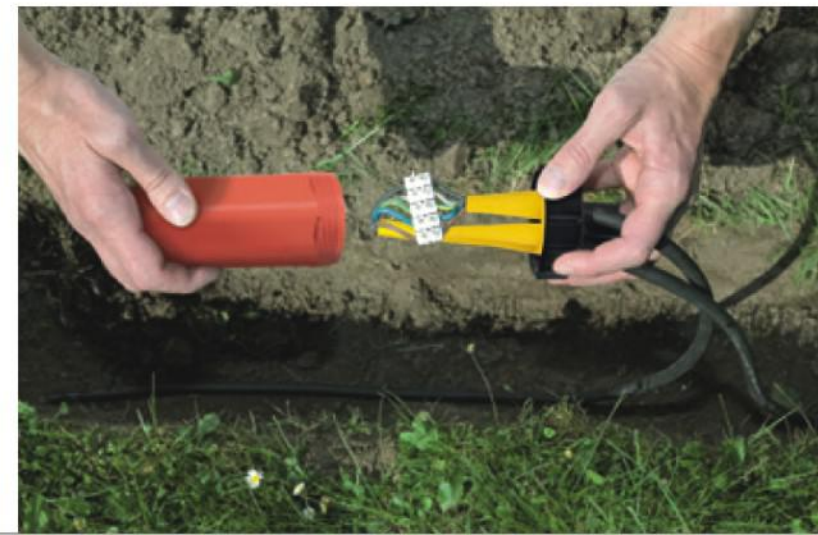
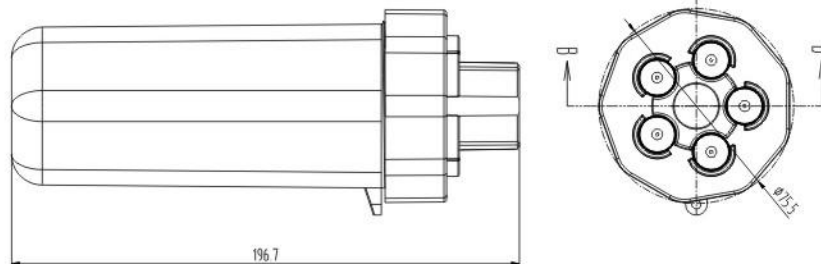

# LCH CONNECTORS

## IP 20 JUNCTION BOXES

# LCH<sup>®</sup>

A brand for connectors in Europe



LCH1408.20-3PB



LCH1408.20-3P

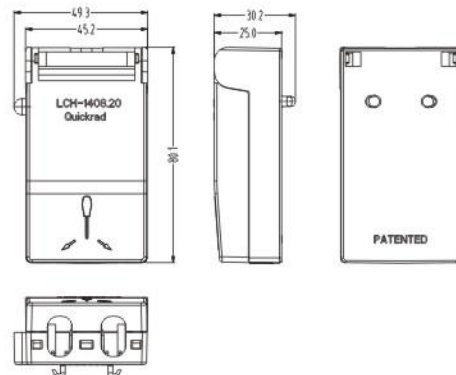
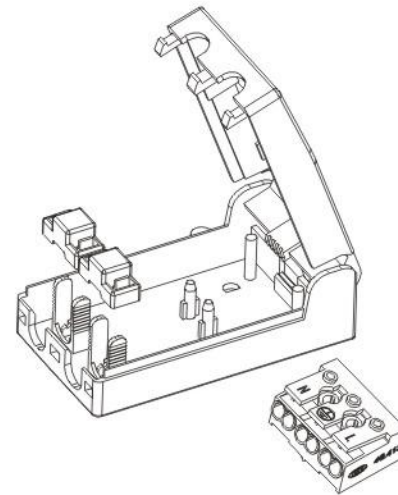

### Test standard:

IEC60998-2-2:2004

IEC62444:2013

IEC60529:1991+A1:2000+A2:2013

### Technical information:

250V/450V, PTI 250, T50, IP 20

16A

### Material Specification:

Housing: PC

Sealing gasket: Silicon

Contact: Copper, nickel plated.

Color: Transparent Blue

### Mechanical Specification:

Termination: 3 pole terminal block

Wiring cable spec:

Φ5mm Min; Φ14mm Max.

**Warranty 3 years limited**



# LCH CONNECTORS

## GR GROMMETS



25/20	M20
29/22	M25
37.5/25	M32
48/30	M40
60/35	M50

Grommet suitable for holes with metric thread in material with a thickness from 1 to 4 mm.  
For completely dust and watertight cable and pipe inlets.



### Description

GR grommets are available in two different materials, Ethylene / propylene (EPDM) rubber and Chloroprene (CR) rubber. They are intended for completely dust and watertight sealing of cables, conduits and pipes, for example in cars, aeroplanes, ships, electrical and hydraulic equipment, enclosed apparatus and light fittings, Both materials are weather and temperature resistant and can be used both indoors and outdoors.

### Advantages

- @Fast installation-seals without tightening of the grommet
- @Permits vibration in cables, conduits and pipes without detracting from the seal
- @The sealing diaphragm is punctured only when the cable is drawn through-acts as a blind plug and is ready for installation
- @Approved for installation in ships
- @Each size has a very wide sealing range.
- @High degree of protection - IP 67

### Approvals

Approved by Lloyds Register of Shipping, Det Norske Veritas for marine and offshore use, and the Swedish, Norwegian, Danish and Finnish national approval boards for watertight penetration  
Degree of protection  
IP 67 in accordance with IEC.



Press the grommet into the hole.

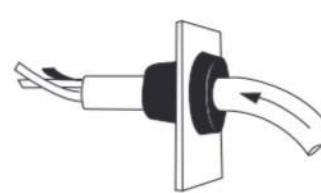

Puncture the diaphragm using the wires from which the outer sheath has been removed.

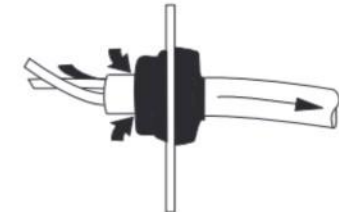

Pull the cable back gently to lock it. The grommet is ready.



# GEAHO LIGHTING

## DOWNLIGHT



GH-DL-50-AL

GH-DL-50-AL

Aluminium

Max 25W

Icon of a lamp and a light bulb with 'HAL/LED' text. Below it is a row of seven energy efficiency icons labeled A++, A+, A, B, C, D, and E, with A++ being the most efficient.

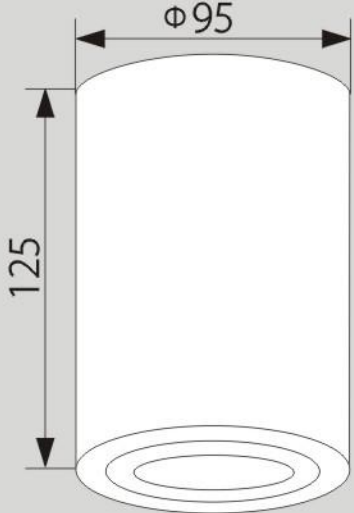

Icon indicating voltage and frequency: 220-240V~ 50/60Hz.

Icon showing a ceiling with an upward arrow, indicating the light is designed for ceiling installation.

Icon showing a light fixture with the text [mm<sup>2</sup>] 3 x (1-2,5), indicating the required cable cross-section.

Icon for IP20 protection rating.

Icon of a house, indicating the light is suitable for residential use.

Icon of a ground symbol, indicating the light is grounded.

Icon for ENEC certification.

Icon for CE certification.



# GEAHO LIGHTING

## DOWNLIGHT



GH-DL-50-W

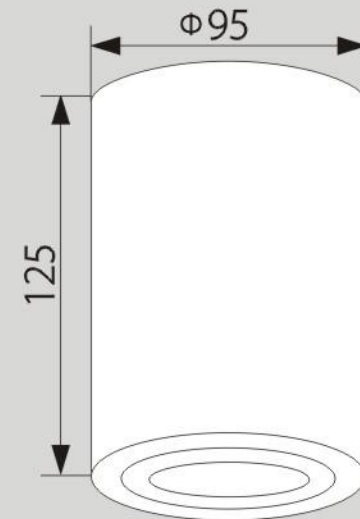

GH-DL-50-W

White

Max 25W

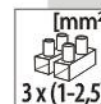
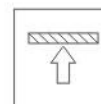

# GEAHO LIGHTING

## DOWNLIGHT



GH-DL-50-B

GH-DL-50-B

Black

Max 25W

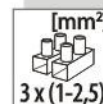
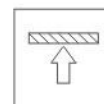
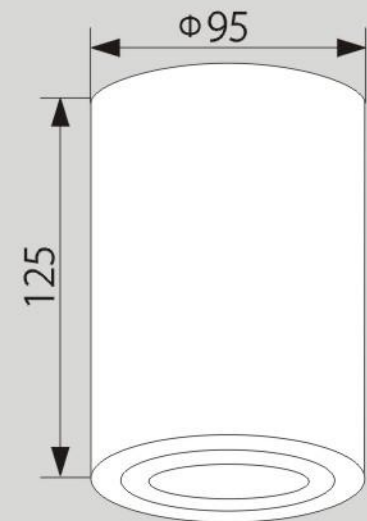
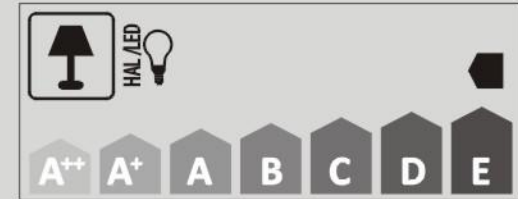



# GEAHO LIGHTING

## TRI-PROOF LIGHT

### Cruiser

Innovative LED water&dust proof fixture, designed to reach a superior performance. A family with 1200mm and 1500mm versions.

#### Material

Housing: aluminium extrusion + Die cast aluminium  
 Powder coated(RAL7016)  
 Diffuser: Opal polycarbonate(PC)  
 Clips: Stainless Steel  
 Fast connector : LCH1108.66FC or LCH1610.68FC

#### LED-SYSTEM AND CONTROL GEAR

Samsung LED 5630  
 Tridonic or Osram Driver  
 Life time: 50000 hours  
 Color temperature: 4000k/5000k  
 Ra:>85

#### Features:

IP66 / IK10  
 Ta: -35°c to 45°c  
 By Fast connecting system, save up 70% wiring time  
 Mounting accessory included, with surface or pendant



Model Number	Color temperature	Lumen Output	System Power	Efficiency	Dimension(mm)
FT-LCP-1200-37-NW	4000K	4255lm	37w	115lm/w	1200x80x95
FT-LCP-1200-37-CW	5000K	4366lm	37w	118lm/w	1200x80x95
FT-LCP-1200-60-NW	4000k	6900lm	60w	115lm/w	1200x80x95
FT-LCP-1200-60-NW	5000k	7080lm	60w	118lm/w	1200x80x95
FT-LCP-1500-52-NW	4000k	5460lm	52w	105lm/w	1500x80x95
FT-LCP-1500-52-CW	5000k	5616lm	52w	108lm/w	1500x80x95
FT-LCP-1500-77-NW	4000k	8085lm	77w	105lm/w	1500x80x95
FT-LCP-1500-77-CW	5000k	8316lm	77w	108lm/w	1500x80x95



Fast Connector

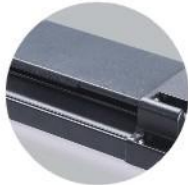

Aluminum Body Stainless Steel Buckle



# CERTIFIED



Ozone resistant



UV resistant



Chlorine resistant



Vibration



Ammonium resistant



Hydrocarbons resistant



# Applications:

- **Dust and waterproof** resistance (IP68)
- **High-quality materials** (UL94 V0) and excellent design / moulding
- High resistance to **mechanical solicitations**



# Special Applications:

**LCH**<sup>®</sup>

A brand for connectors in Europe

## Applications

- Oil and gas
- Monitoring equipments
- Gas detection systems
- Mines

## Customers

- Manufacturers (OEMs)
- Installation Companies
- Electric / Water / Oil & Gas Utilities

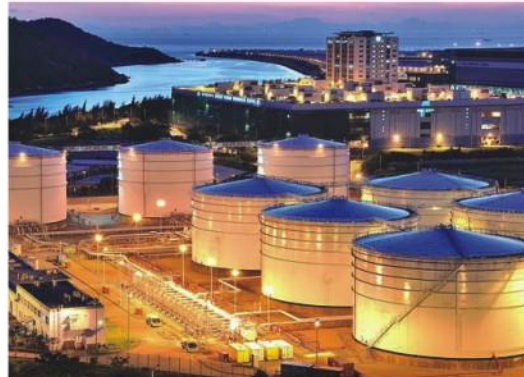

# Target Projects - LOW-VOLTAGE INSTALLATION



**Ports**



**Bridges**



**Architectural lighting**



**Plants**



**Petrol Stations**



**Events lighting**





HENG PENG INTERNATIONAL

ГК РАДИОТЕХ

127015, Россия, Москва, ул. Новодмитровская, д.2, корп.2, этаж 14, офис "Радиотех".

8-495-795-08-05

8-495-795-08-72

8-495-795-08-73

[info@rct.ru](mailto:info@rct.ru)

[www.rct.ru](http://www.rct.ru)